

Assembly Instructions

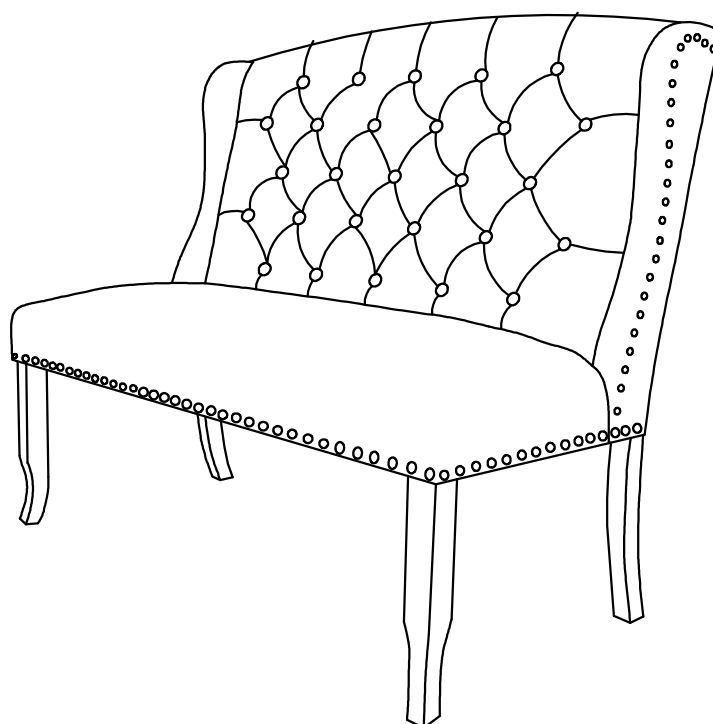
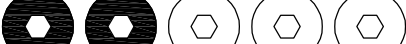

ASSEMBLY RATING

The Assembly Rating is a 5-point system that shows the degree of effort needed in assembling a specific product (with 1 being easy and 5 being difficult). For some products, two persons are recommended.

EASY  DIFFICULT

Tools Required For Assembly:

Allen Wrench

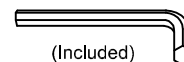

(Included)

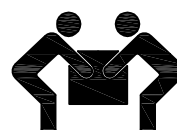

2 PERSONS RECOMMENDED

ASSEMBLY & CARE ADVICE

FOR YOUR FURNITURE TO LAST, CORRECT ASSEMBLY AND PROPER MAINTENANCE ARE NECESSARY. PLEASE FOLLOW THE INFORMATION PROVIDED BELOW TO FULLY ENJOY YOUR FURNITURE.

BASIC ASSEMBLY TECHNIQUES

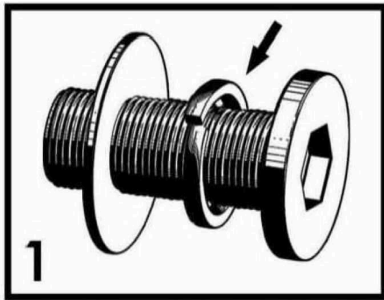

1
When lock or spring washer is used in an assembly, please make sure the lock or spring washer is placed between the larger flat washer and the head of the screw or bolt.

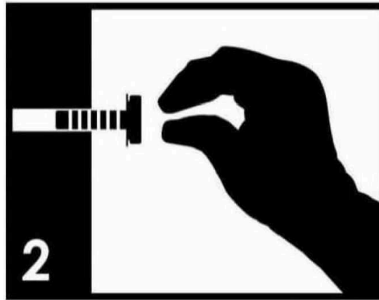

2
Position each part correctly and insert screws or bolts into their respective holes by hand tighten or using the proper hand tool. Only tighten when step is completed or when instructed to do so.

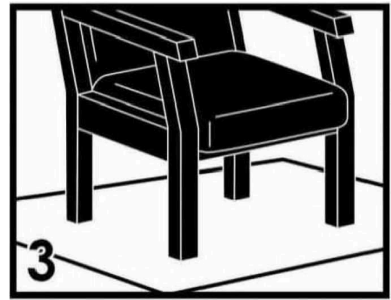

3
Use cardboard or carpet area when assembling furniture to prevent scratches. Make sure the furniture rests on a flat and level surface with each leg evenly touching the floor.

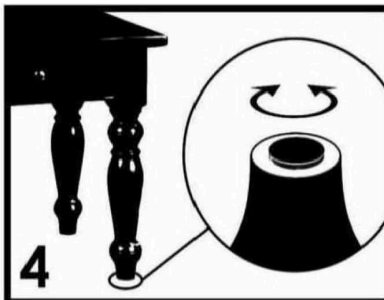

4
Some furniture comes with height adjustment knobs underneath each leg. To lower or to raise each leg, you need to turn clockwise or counterclockwise, respectively.

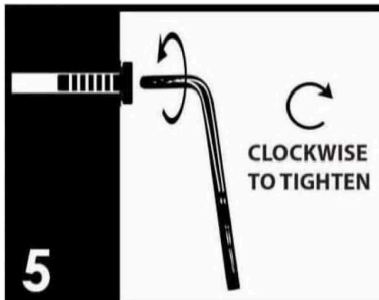

5
Make sure all parts are properly aligned, then use the appropriate hand tool to completely tighten the bolts or screws. Do not use power tools and do not overtighten.

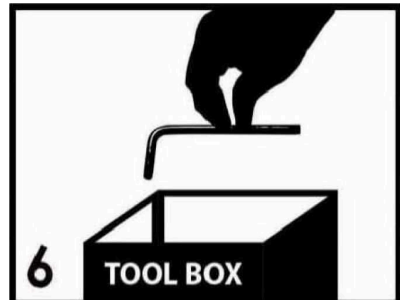

6
Save the instructions and store the Allen wrench or any supplied tool for later maintenance. After two weeks, check and tighten any loose hardware and repeat again every six months thereafter.

IT IS THE USER'S RESPONSIBILITY TO MAINTAIN THE FURNITURE. THE HARDWARE MAY LOOSEN OVER TIME AND MAY CAUSE THE FURNITURE TO BE WOBBLY AND UNABLE TO SUPPORT ITS INTENDED WEIGHT CAPACITY. THIS MAY LEAD TO COLLAPSE AND MAY CAUSE SERIOUS INJURY.

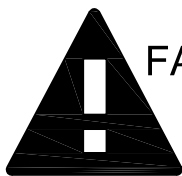

FAILURE TO FOLLOW THE GUIDELINES ABOVE MAY RESULT IN INJURY AND/OR PROPERTY DAMAGE.

ALL RIGHTS RESERVED.

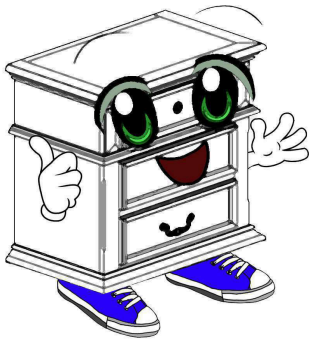

Before you begin, please read Page 2 of "Assembly and Care Advice".

And remember, do not tighten until each step is completed or instructed.

Parts List

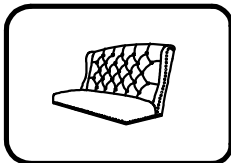

#1 x 1pc
Seat Cushion

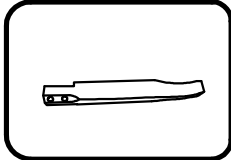

#2 x 2pcs
Front Leg

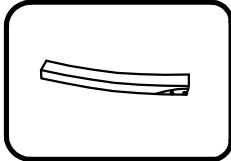

#3 x 1pc
Left Rear Leg

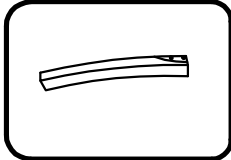

#4 x 1pc
Right Rear Leg

Hardware List

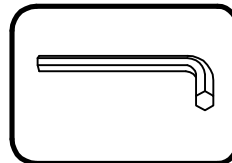

#A x 1pc
Allen Wrench M5

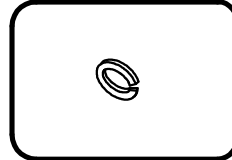

#B x 8pcs
Lock Washer 5/16"

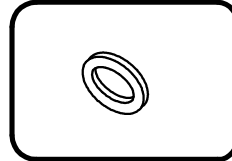

#C x 8pcs
Flat Washer 5/16"

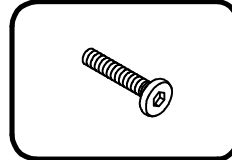

#D x 8pcs
Bolt 5/16" x 2-1/2"

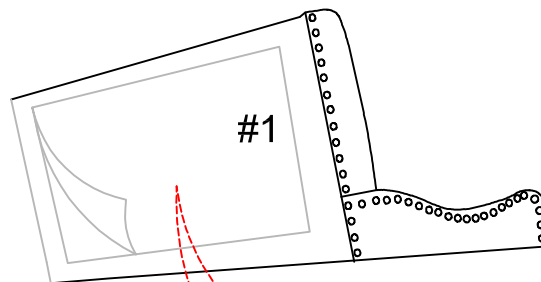

Find legs in the bottom velcro compartment of the seat (#1).



#B x 4pcs
#C x 4pcs
#D x 4pcs

1. Prepare 4 bolt assemblies by first inserting a lock washer (#B) onto the bolt (#D) then a flat washer (#C) onto that same bolt (#D).

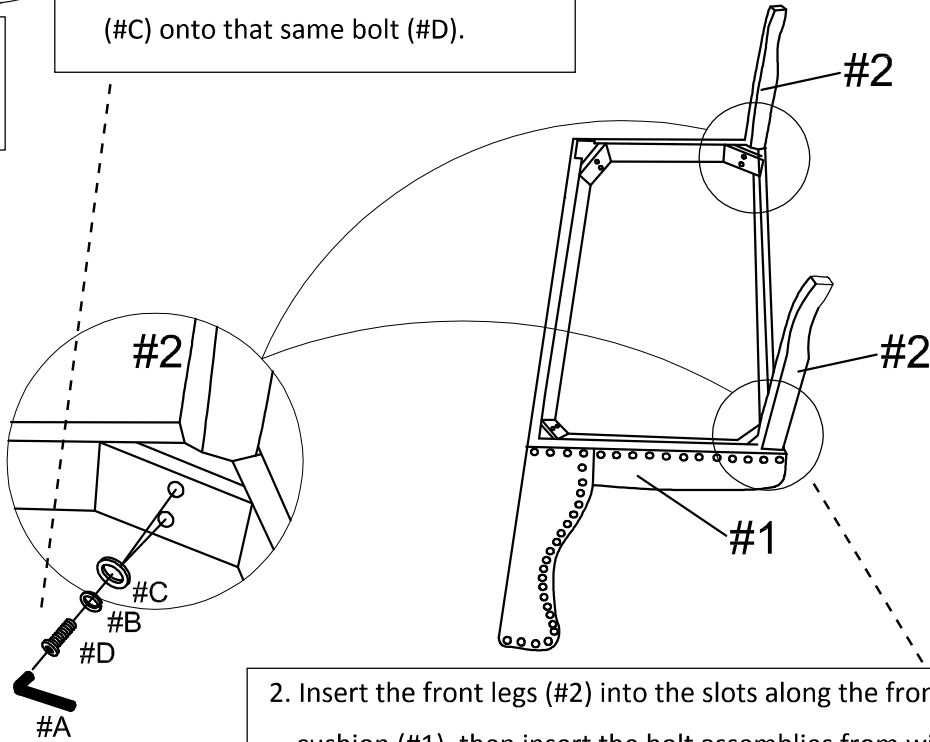

2. Insert the front legs (#2) into the slots along the front of the seat cushion (#1), then insert the bolt assemblies from within and secure.



#B x 4pcs
#C x 4pcs
#D x 4pcs

2. Insert the rear legs (#3,4) into the slots along the back of the seat cushion (#1), then insert the bolt assemblies from within and secure.

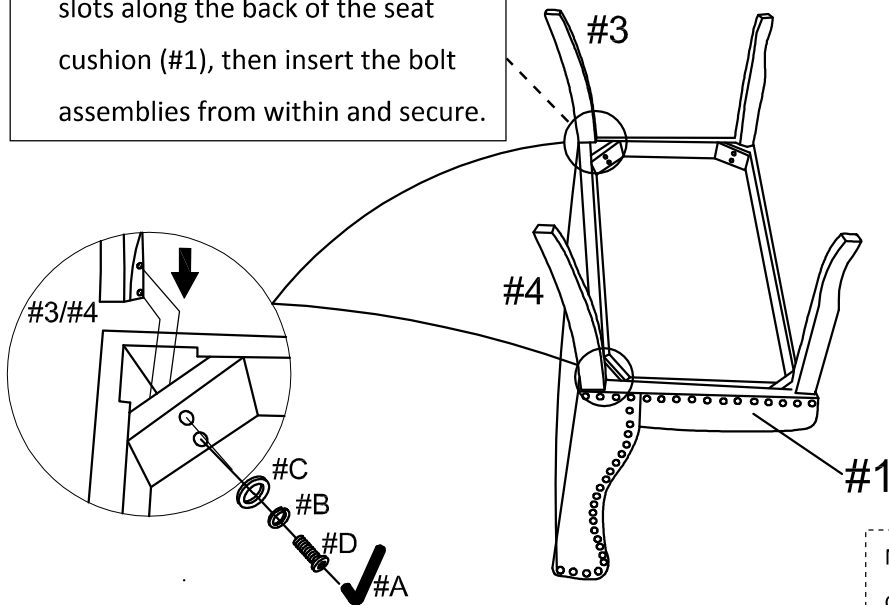

Note: Left and right is determined by facing the front of the bench in its upright position.

1. Prepare 4 bolt assemblies by first inserting a lock washer (#B) onto the bolt (#D) then a flat washer (#C) onto that same bolt (#D).



If wobbly, please ensure to level the chair with the flooring, and adjust the bolts gradually until the chair does not wobble anymore

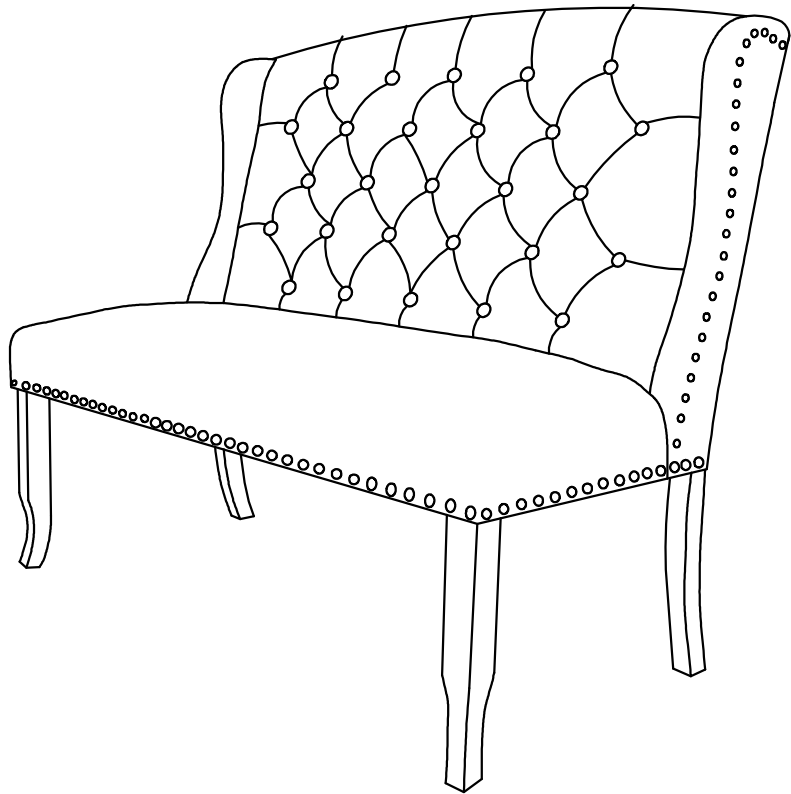

ASSEMBLY IS COMPLETED