









Accessories detailed list

E29#Writing desk Construction elucidation diagram

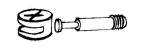
Packing box:

- 4--1 2040\*1040\*110 Front-panel, connect the plank, medium drawer scaleboard
- 4--2 1030\*660\*650 Left bucket
- 4--3 1030\*660\*650 right bucket
- 4--4 830\*390\*100 In-between drawer

NO.	NAME	Specification	QTY	Picture
1	Wrench		1pcs	
2	Blank page		4pcs	
3	Screw	8*16	40pcs	
4	Screw pole	8*250	8pcs	
5	Screw pole	8*50	8pcs	
6	Hold hands		6pcs	
7	3 into 1		25set	
8	Wood	8*30	40pcs	
9	Iron		2set	
10	Screw	3*16	40pcs	

Installation steps:

1. Open each packing, put left bucket and right buckets according to medium the drawer scaleboard distance to put, use three unite as one the accessories and the wood mans to link medium drawer scaleboard, backboard and or so buckets, wind up the accessories.
2. The gearing leads the track, and pack the medium drawer up.
3. Wind up front-panel to from the upper cover next, screw.
4. Install the post and feet, install to complete.

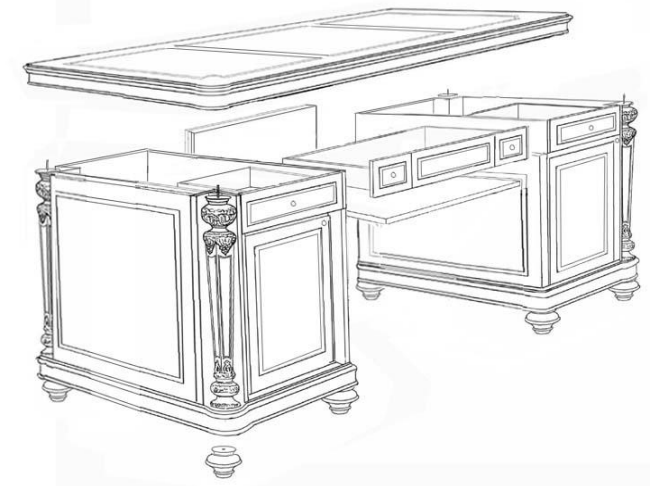

maker:Bean sprout

Examine:

Date:2006-04-03