

ASSEMBLY INSTRUCTIONS

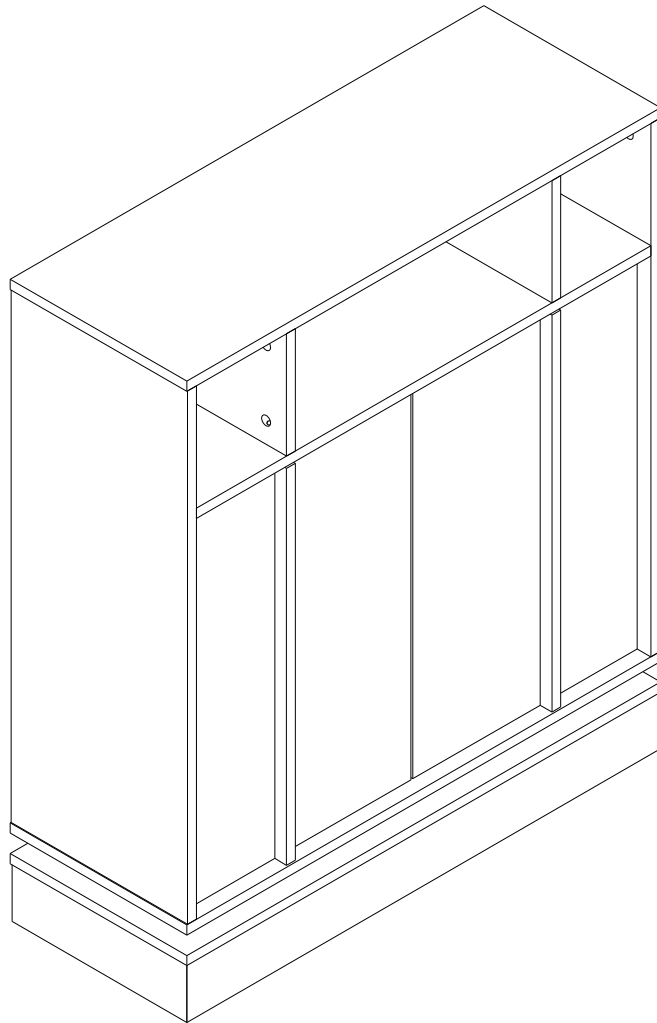

Notice:

1. Follow the installation instructions. Please confirm all accessories are preset before installation.
2. Do not fully tighten the screws during initial assembly. Fully tighten screws only once all pieces which are correctly assembled.
3. If you encounter any problems during installation, please contact our customer service.
4. Please unbox the item from the side with an open-label and put a carpet on the floor to avoid scratching it.

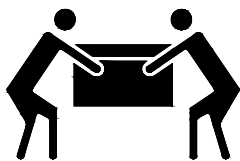

Recommended installers:2

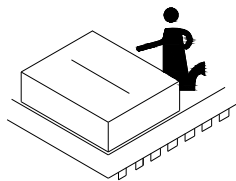

Put a carpet on the floor
before unpacking

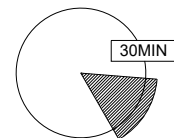

Estimate installation time:
30minutes





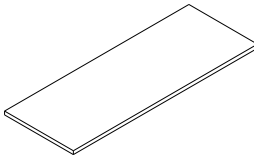
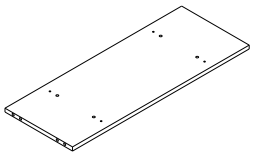
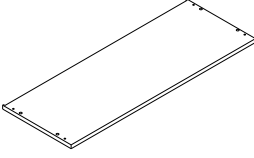
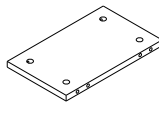
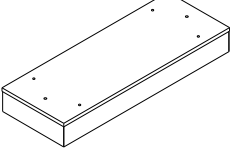
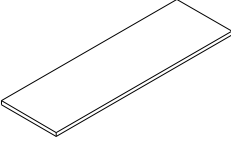
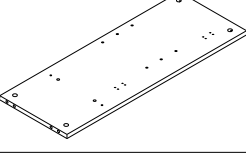
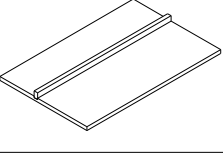
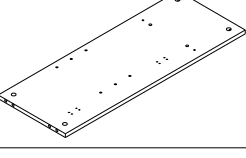
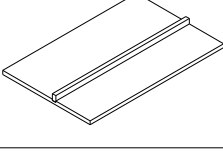
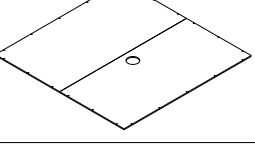





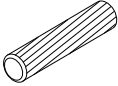

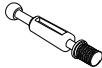
ASSEMBLY INSTRUCTIONS

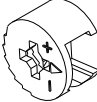
PART LIST

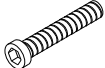
| Item no. | Reference Image | Qty | | Item no. | Reference Image | Qty |
|----------|---|-----|--|----------|---|-----|
| Ⓐ |  | X1 | | Ⓕ |  | X1 |
| Ⓑ |  | X1 | | Ⓖ |  | X2 |
| Ⓒ |  | X1 | | Ⓖ |  | X1 |
| Ⓓ |  | X1 | | Ⓖ |  | X1 |
| Ⓔ |  | X1 | | Ⓖ |  | X1 |
| | | | | Ⓖ |  | X1 |
| | | | | | | |
| | | | | | | |
| | | | | | | |

ASSEMBLY INSTRUCTIONS

HARDWARE LIST

| Item no. | Reference Image | Qty | Item no. | Reference Image | Qty |
|----------|---|-------|----------|--|-------|
| 1 |  Ø8*30mm | X24+2 | 7 |  Ø3*15mm | X21+2 |
| 2 |  | X20+2 | 8 |  | X4 |
| 3 |  | X20+2 | 9 |  | X4 |
| 4 |  Ø1/4"*1-1/4" | X2 | 10 |  Ø3*14mm | X24+2 |
| 5 |  | X2 | 11 |  | X1 |
| 6 |  | X2 | 12 |  | X1 |
| | | | | | |
| | | | | | |
| | | | | | |
| | | | | | |

ASSEMBLY INSTRUCTIONS

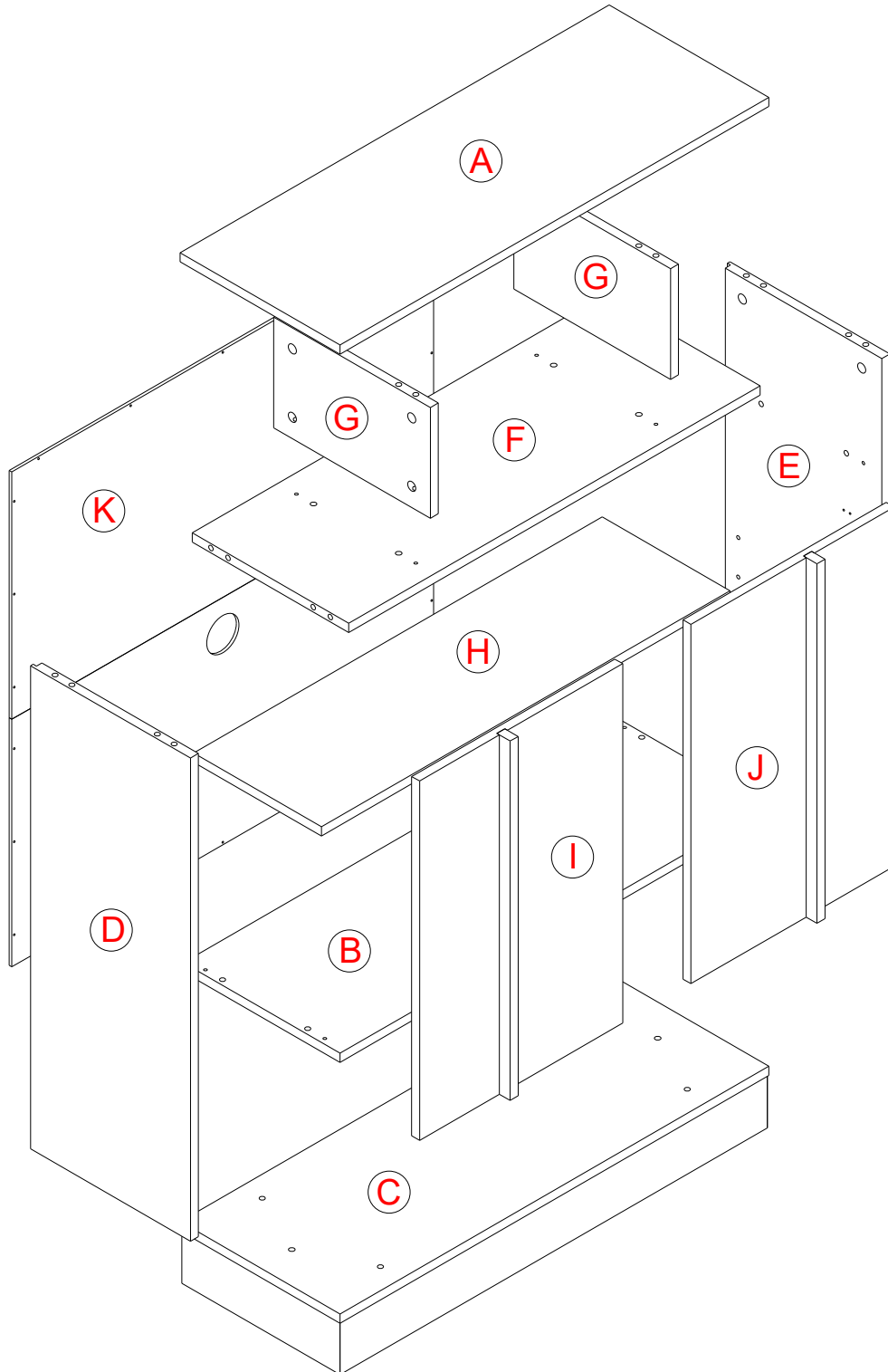

ASSEMBLY INSTRUCTIONS

1

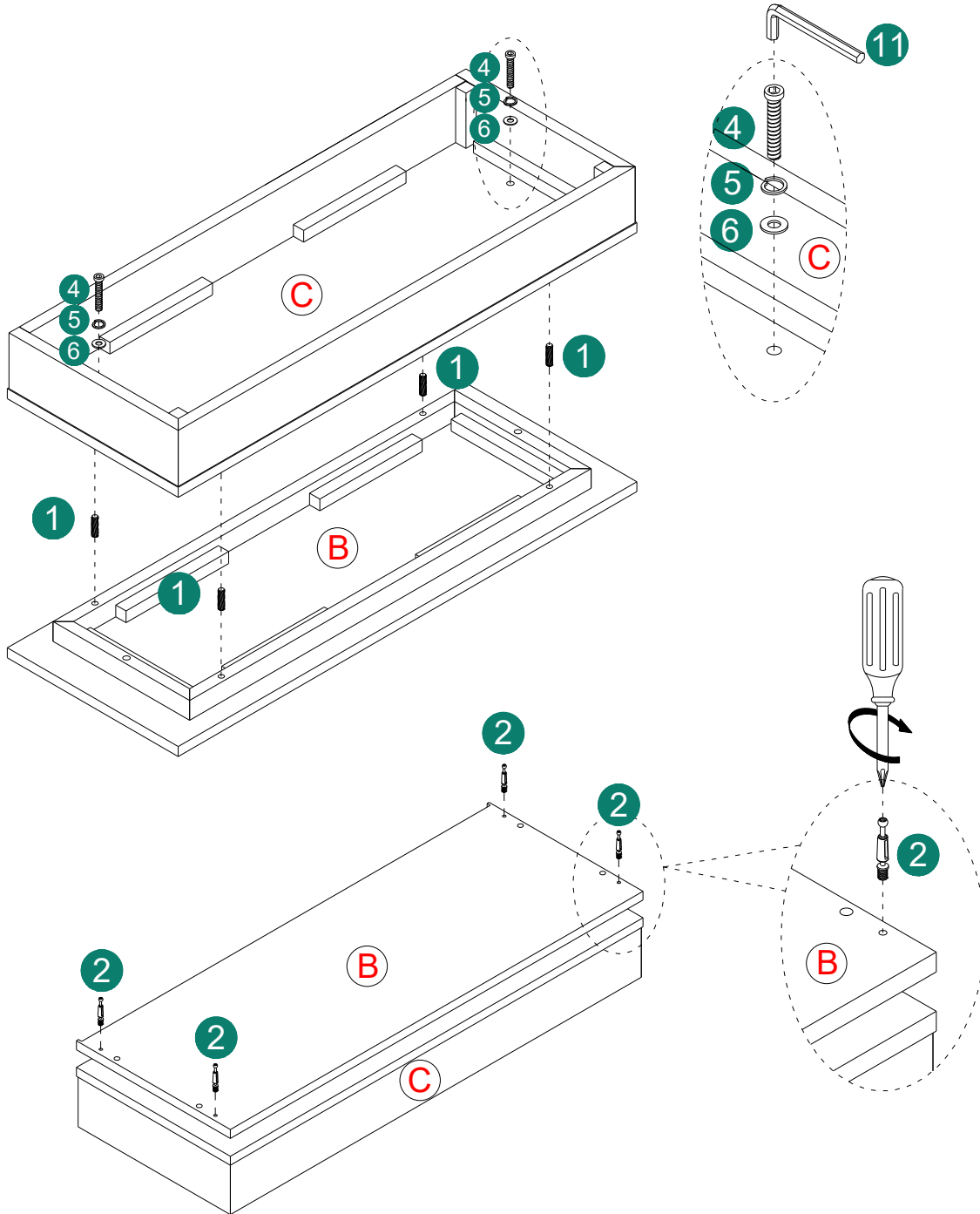
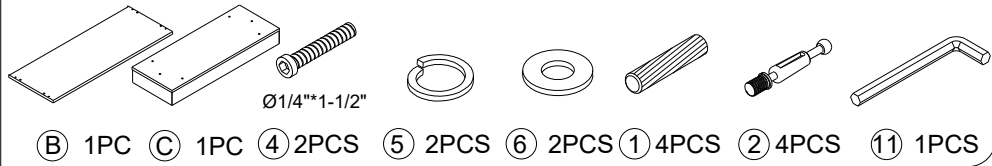

ASSEMBLY INSTRUCTIONS

2

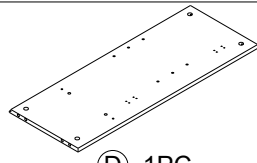

Ⓓ 1PC

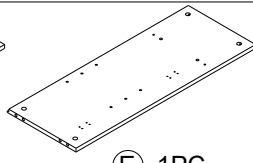

Ⓔ 1PC

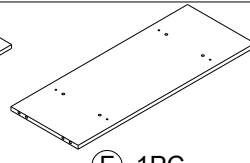

Ⓕ 1PC



② 8PCS

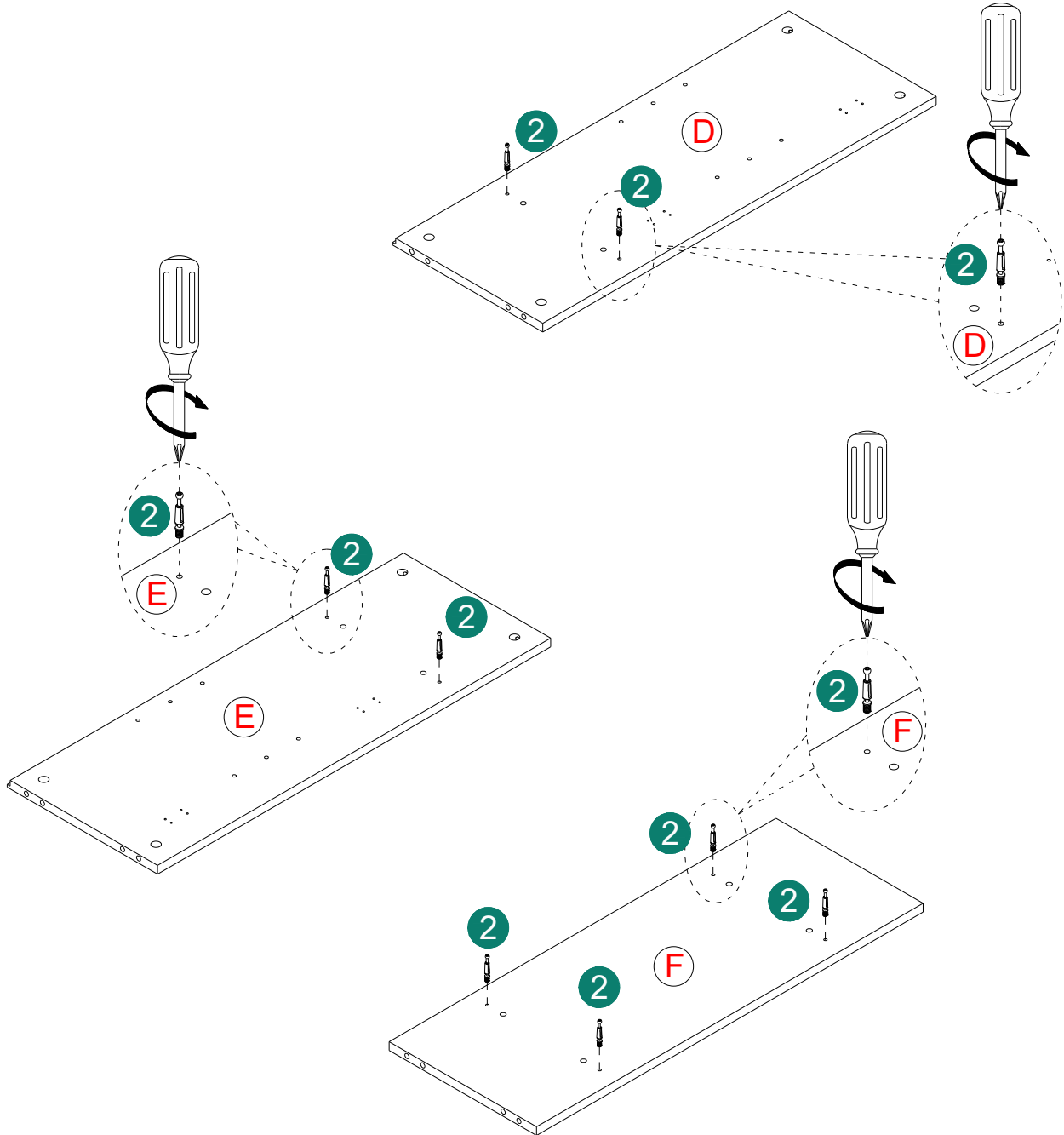

ASSEMBLY INSTRUCTIONS

3

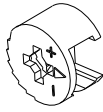

③ 8PCS

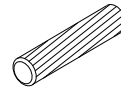

① 8PCS

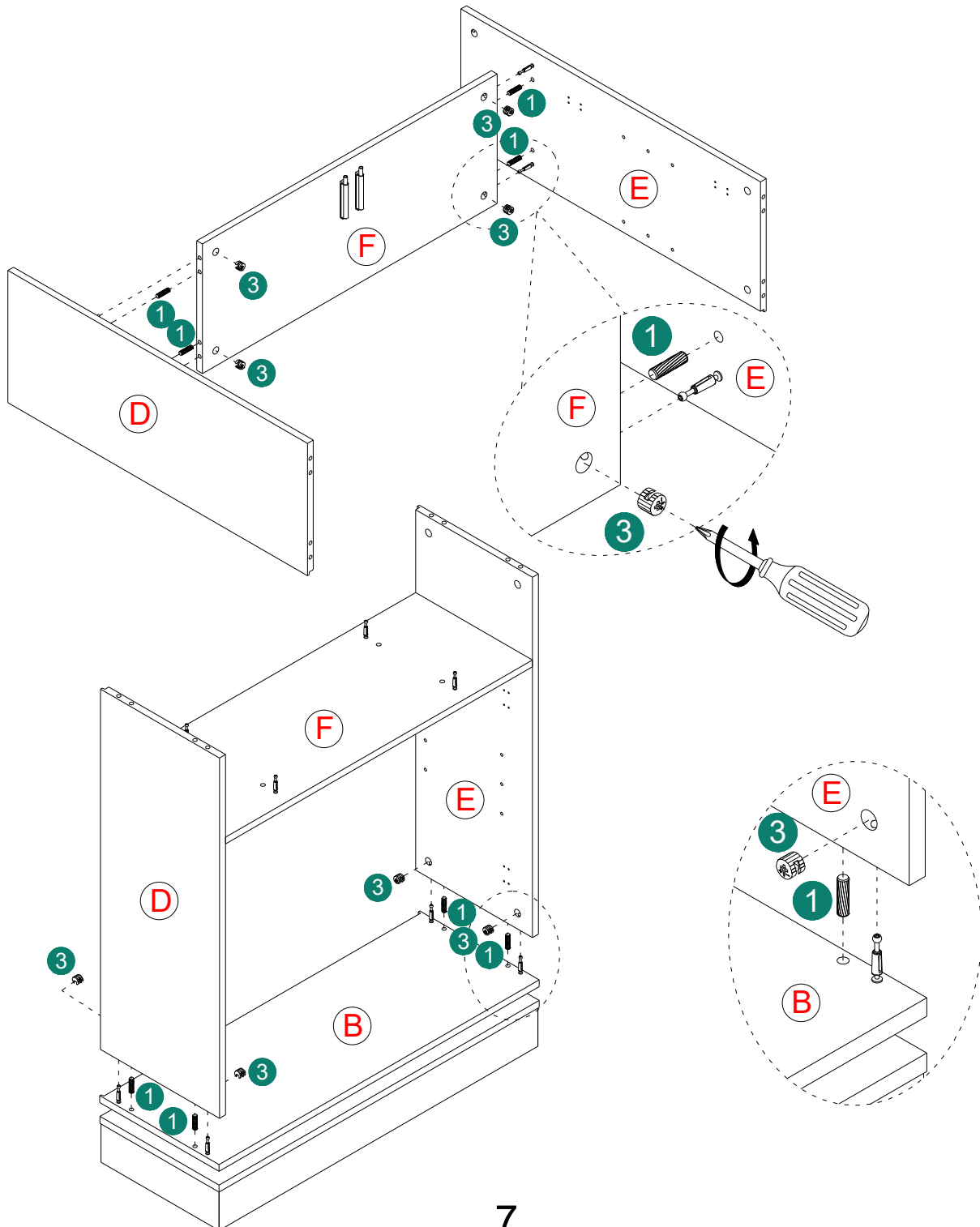

ASSEMBLY INSTRUCTIONS

4

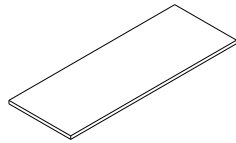

(A) 1PC

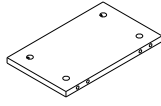

(G) 2PC

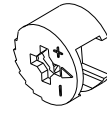

(3) 4PCS

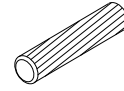

(1) 4PCS



(2) 8PCS

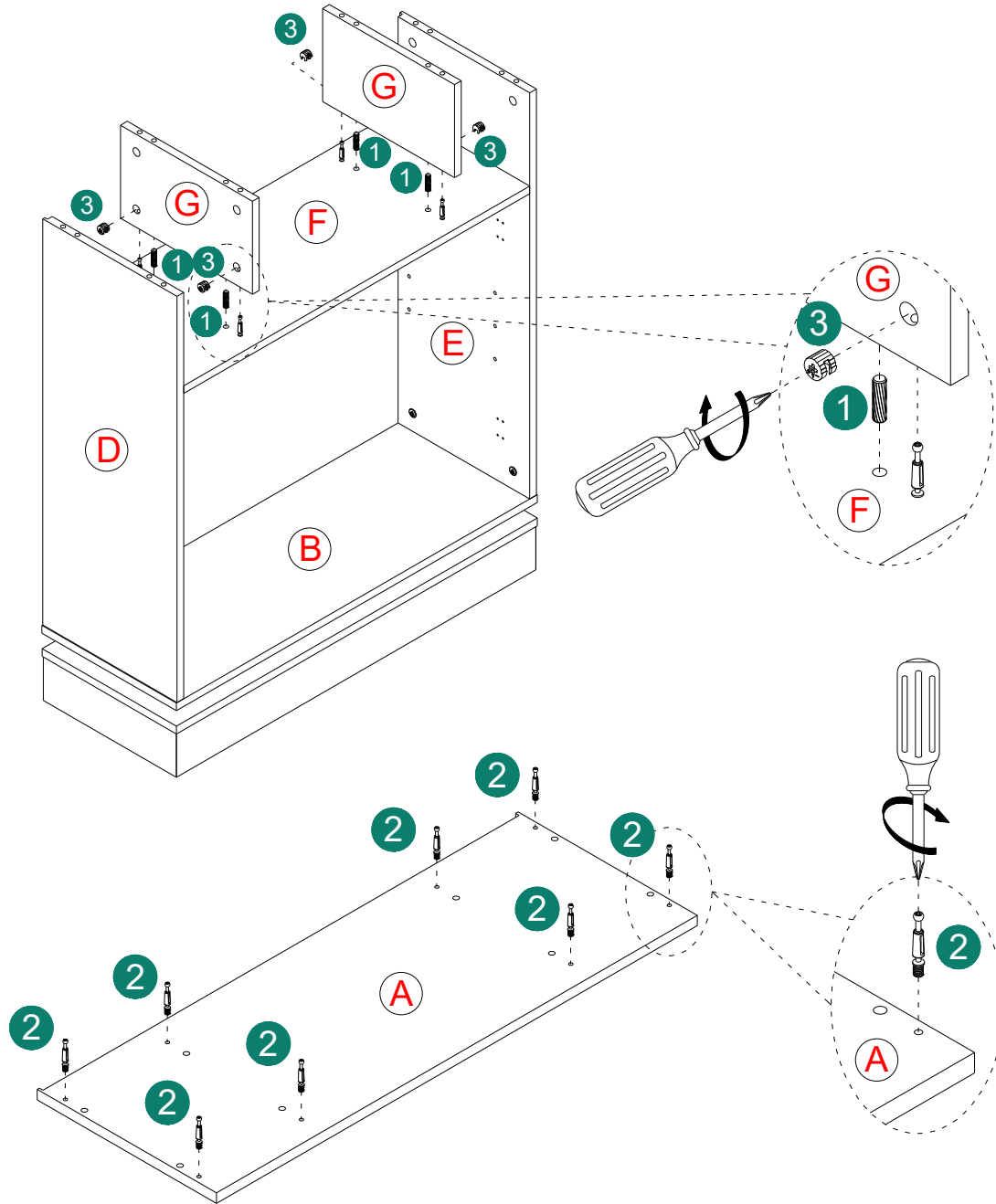

ASSEMBLY INSTRUCTIONS

5

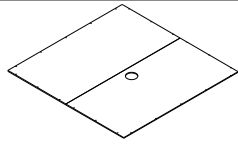

(K) 1PC

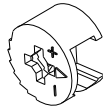

(3) 8PCS

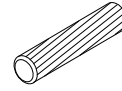

(1) 8PCS



Ø3*15mm
(7) 21PCS

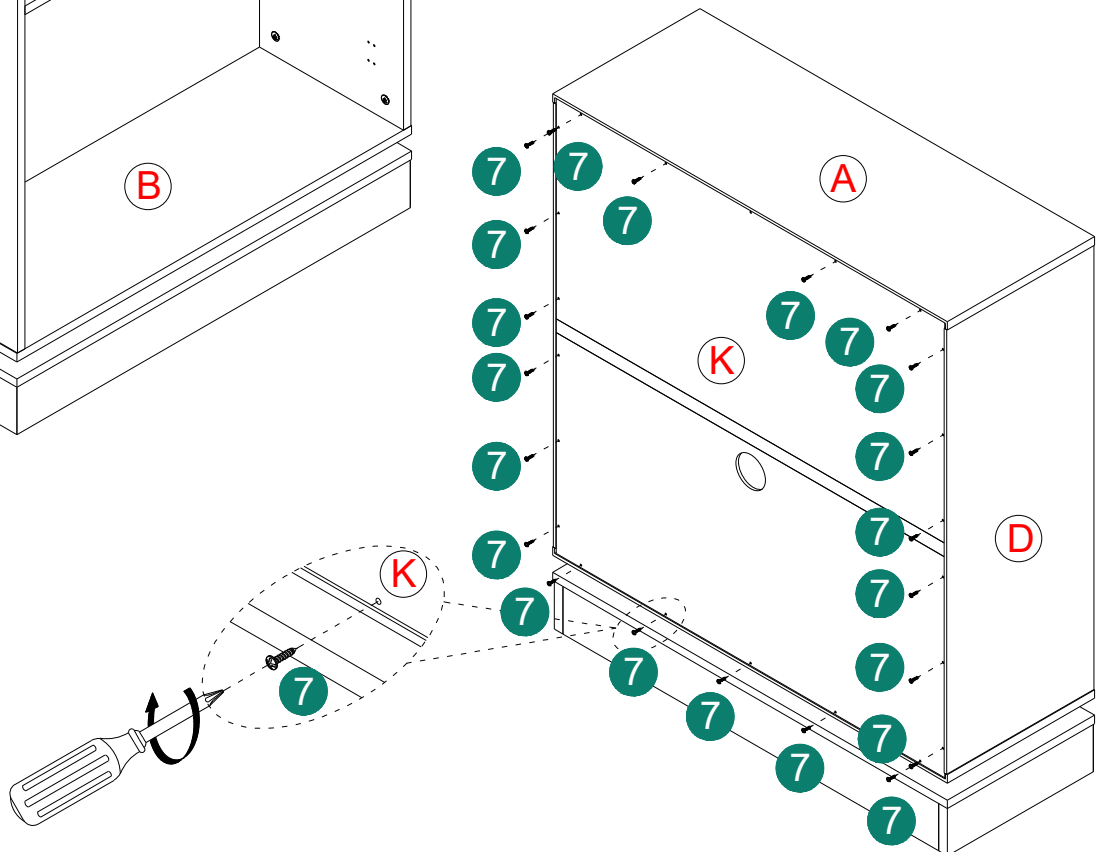
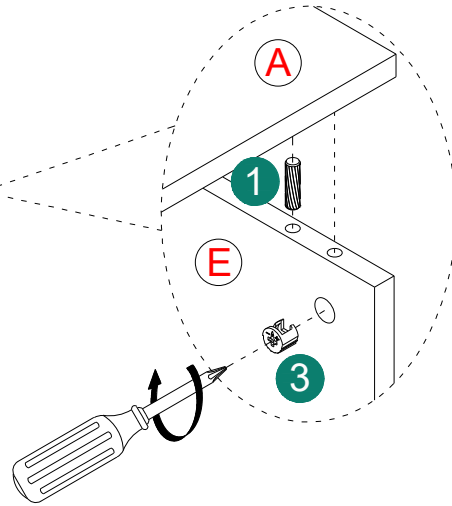
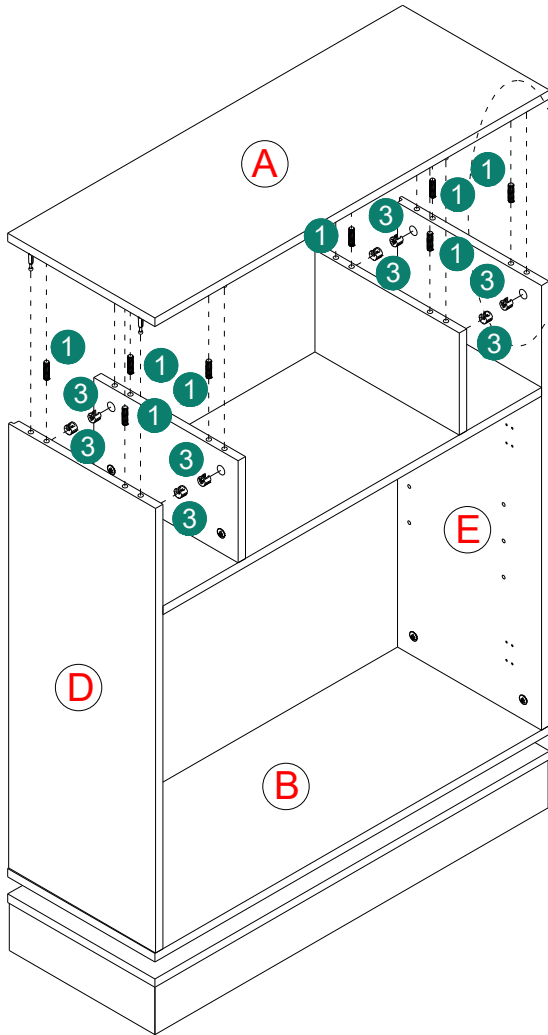

ASSEMBLY INSTRUCTIONS

6

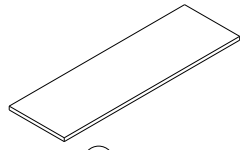

(H) 1PC



(8) 4PCS

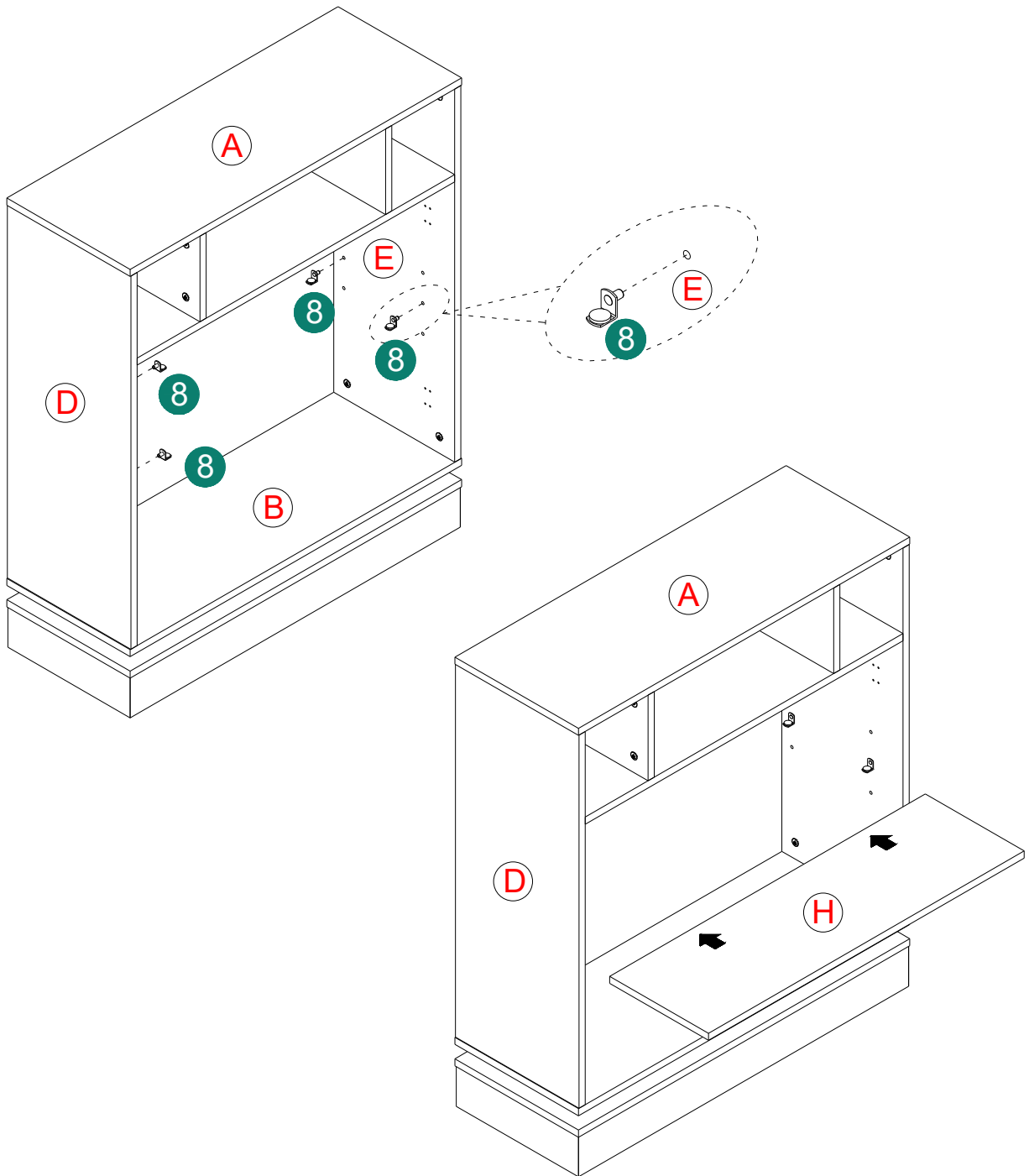

10

ASSEMBLY INSTRUCTIONS

7

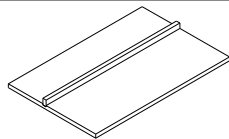

I 1PC

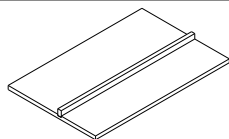

J 1PC

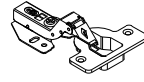

9 4PCS



Ø3*14mm

10 8PCS

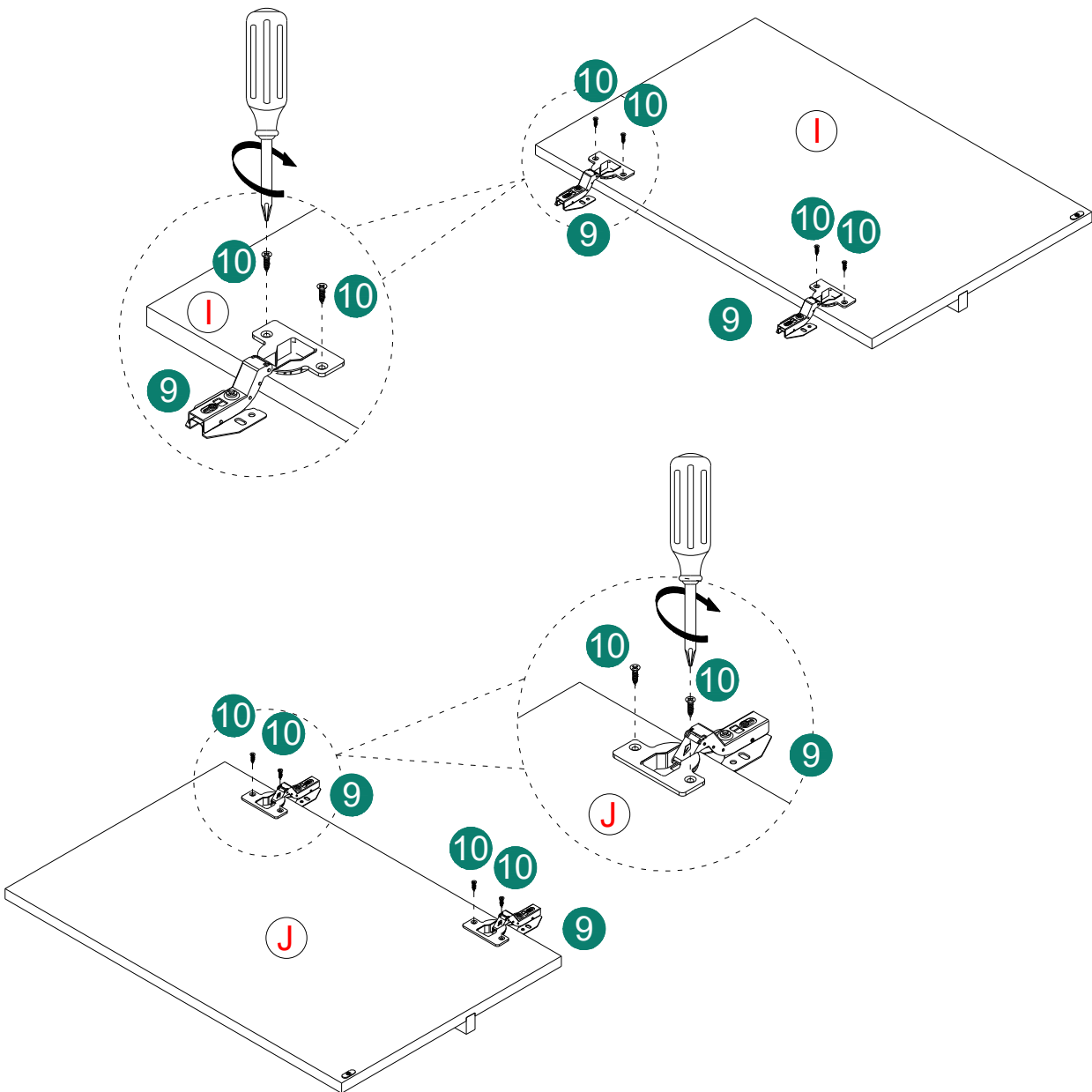

ASSEMBLY INSTRUCTIONS

8



Ø3*14mm

10 16PCS

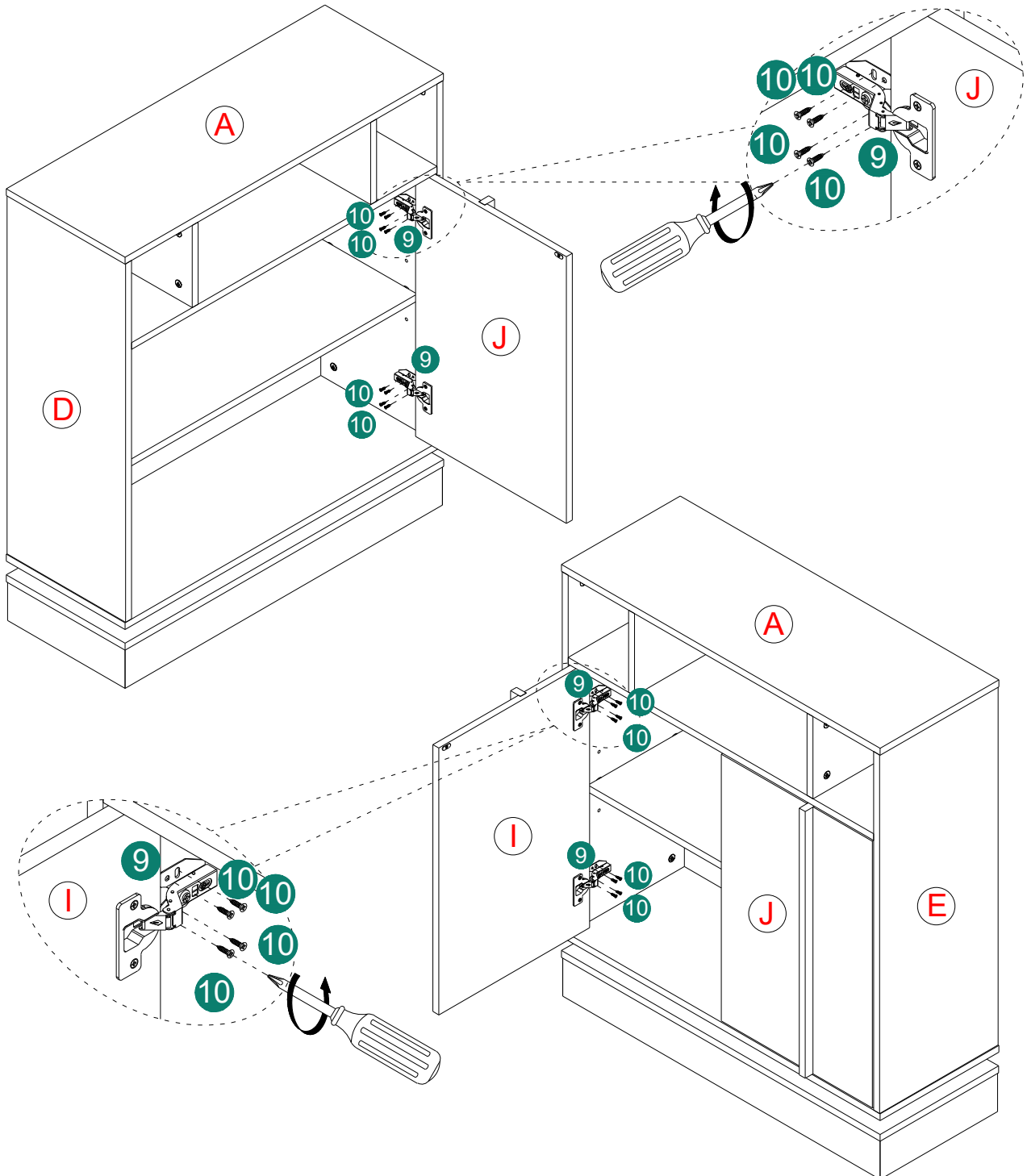

ASSEMBLY INSTRUCTIONS

9

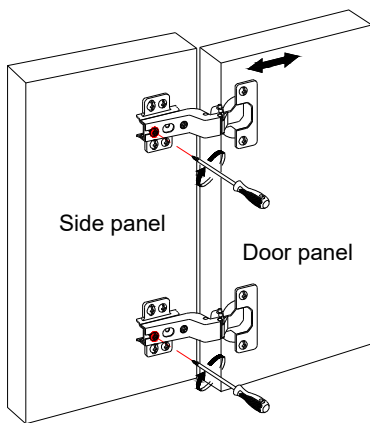

①

Front-to-Back Direction Adjustment:

Rotate the screws on the door hinges shown in the image. The door panel can be moved front-back.

Adjustment range: 4mm

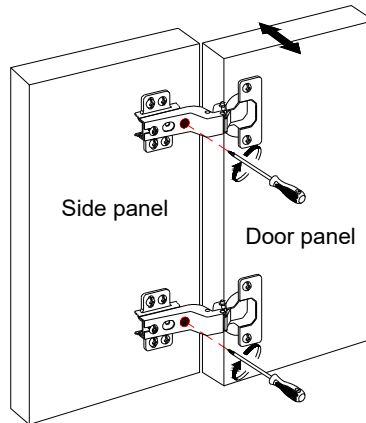

②

Left-Right Direction Adjustment:

Rotate the screws on the door hinges shown in the image. The door panel can be moved left-right.

Adjustment range: 3mm

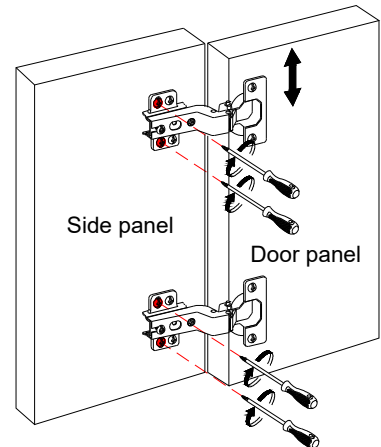

③

Up-Down Direction Adjustment:

Rotate the screws on the door hinges shown in the image. The door panel can be moved up-down.

Adjustment range: 4mm

ASSEMBLY INSTRUCTIONS

10

Common Door Panel Issues:

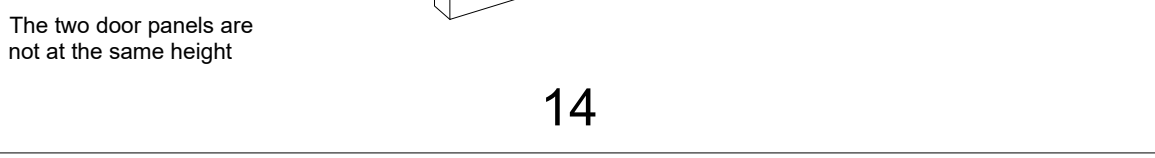
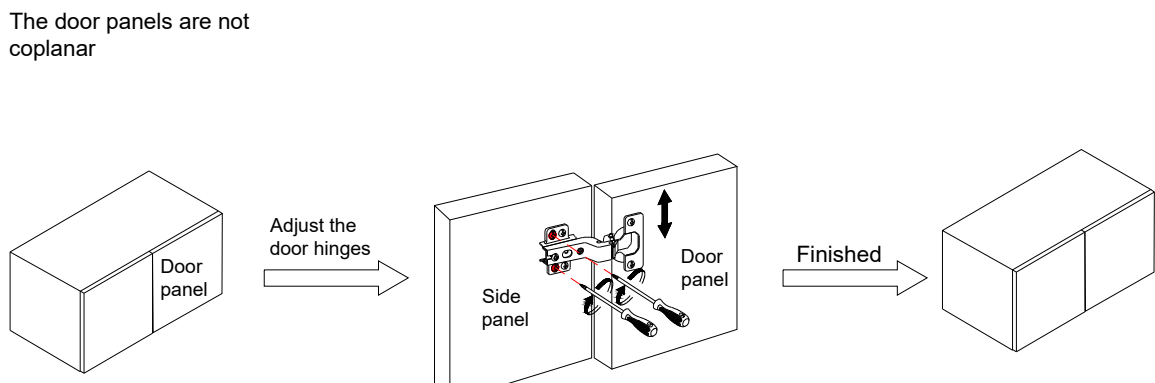
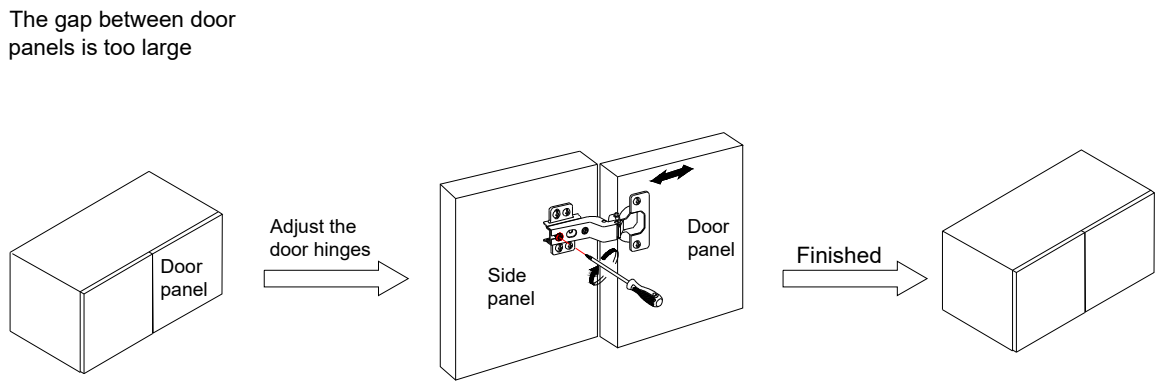
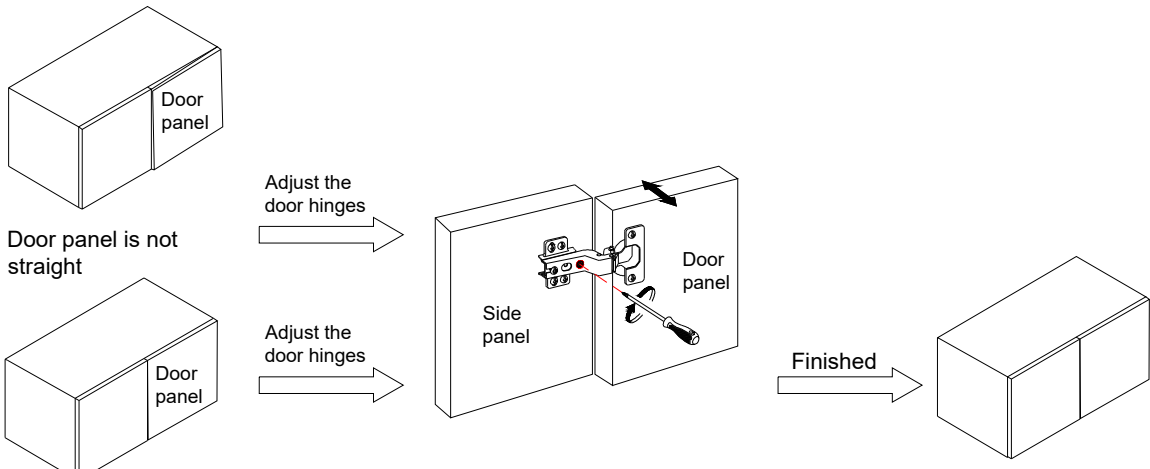

ASSEMBLY INSTRUCTIONS

11

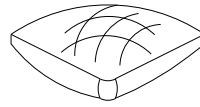

⑫ 1set

A

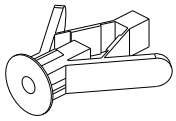

1pcs

B

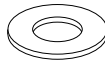

2pcs

C

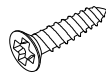

Ø8*3/4"
1pcs

D

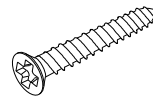

Ø8*1-1/2"
1pcs

E

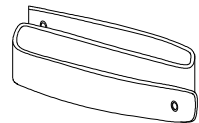

1pcs

