



## Tips:

- ① Do not tighten any bolts until it tells you to.
- ② It will save you one hour.
- ③ You can loose all the screws, just little on the nuts.

# Patio Chaise Lounge Chair

## ASSEMBLY MANUAL

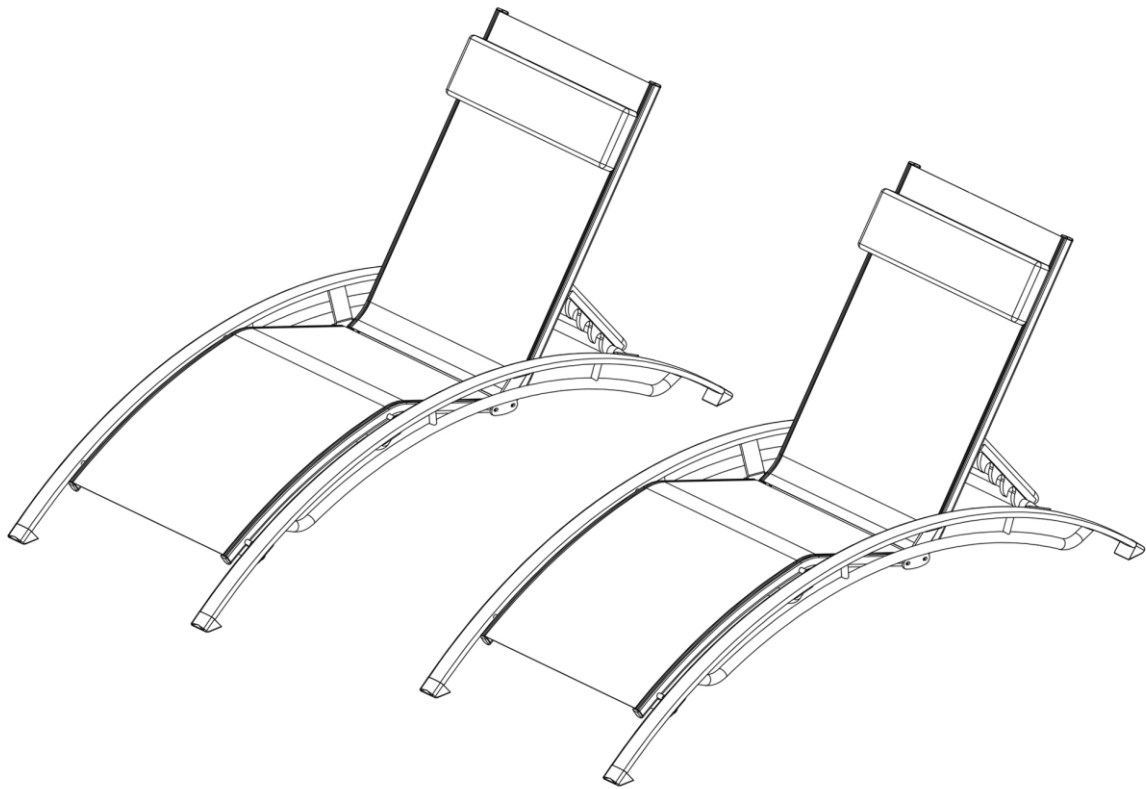

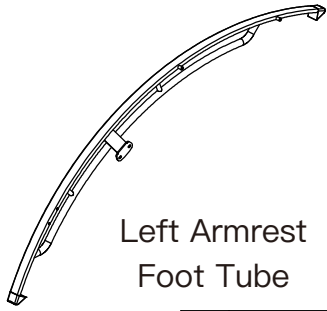

Left Armrest  
Foot Tube

A1 2PCS

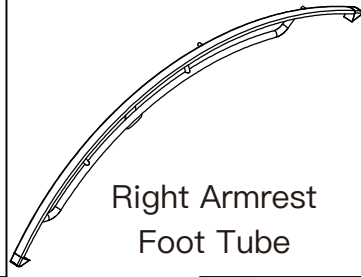

Right Armrest  
Foot Tube

B1 2PCS

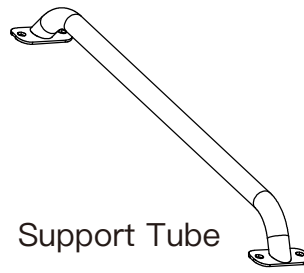

Support Tube

C1 4PCS

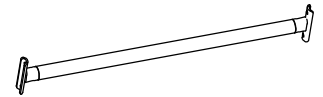

Support Tube

D1 2PCS

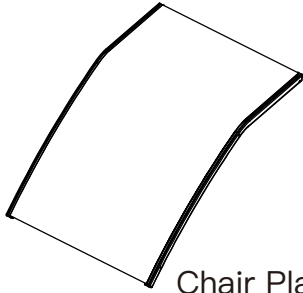

Chair Plate

E1 2PCS

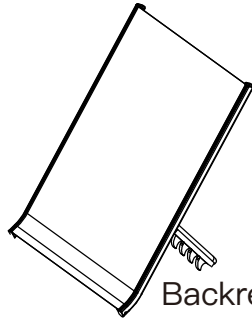

Backrest

F1 2PCS

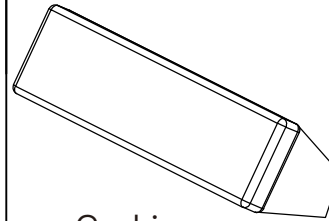

Cushion

G1 2PCS

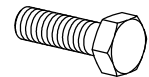

Bolts

H1 M6\*16 24PCS

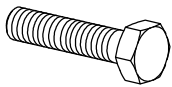

Bolts

I1 M6\*35 16PCS



Plastic End Caps

J1 8PCS



Plastic End Caps

K1 40PCS



Plastic Washers

L1 8PCS



Metal Flat Washers  
(Large Size)

M1 12PCS



Metal Flat Washers  
(Large Size)

N1 28PCS



Spring Washers

O1 8PCS



Hex Nuts

P1 8PCS

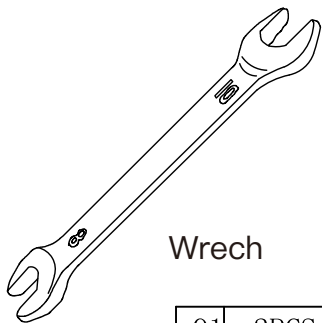

Wrench

Q1 2PCS

## This is the instruction of 2 Lounge Chairs.



**Friendly Tip:** PLEASE DON'T COMPLETELY TIGHTEN THE SCREWS DURING ASSEMBLY. After all the screws are assembled in place, tighten them together.

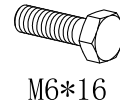
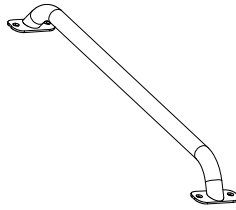
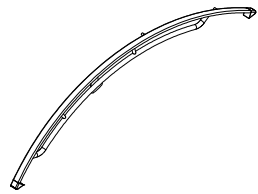
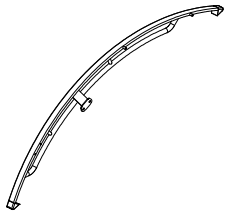



A1	1PCS	B1	1PCS	C1	2PCS	H1	8PCS	N1	8PCS
----	------	----	------	----	------	----	------	----	------

### Step 1:

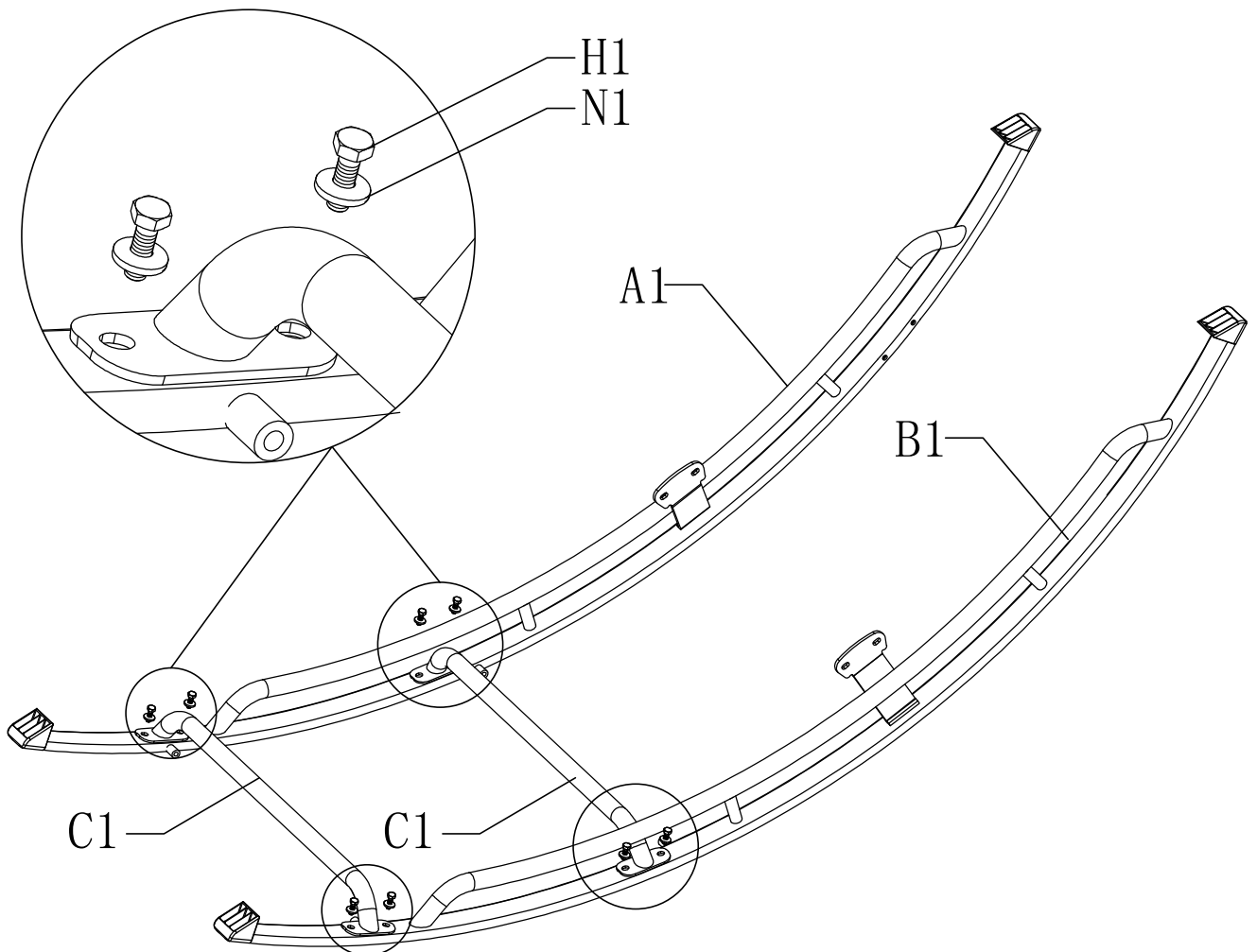
Connect armrests #A1 and #B1 using 2 support tubes #C1, as depicted in the provided image, and secure them with the hardware #H1 and #N1.

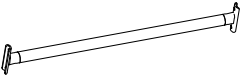
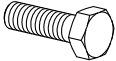

**WARNING:** Please REFRAIN from fully tightening the screws until all of them have been properly positioned.

		 M6*16			
D1	1PCS	H1	4PCS	N1	4PCS

**Step 2:**

Attach another support tube (#D1) between armrests (#A1 and #B1) as shown with hardware (#H1 and #N1).

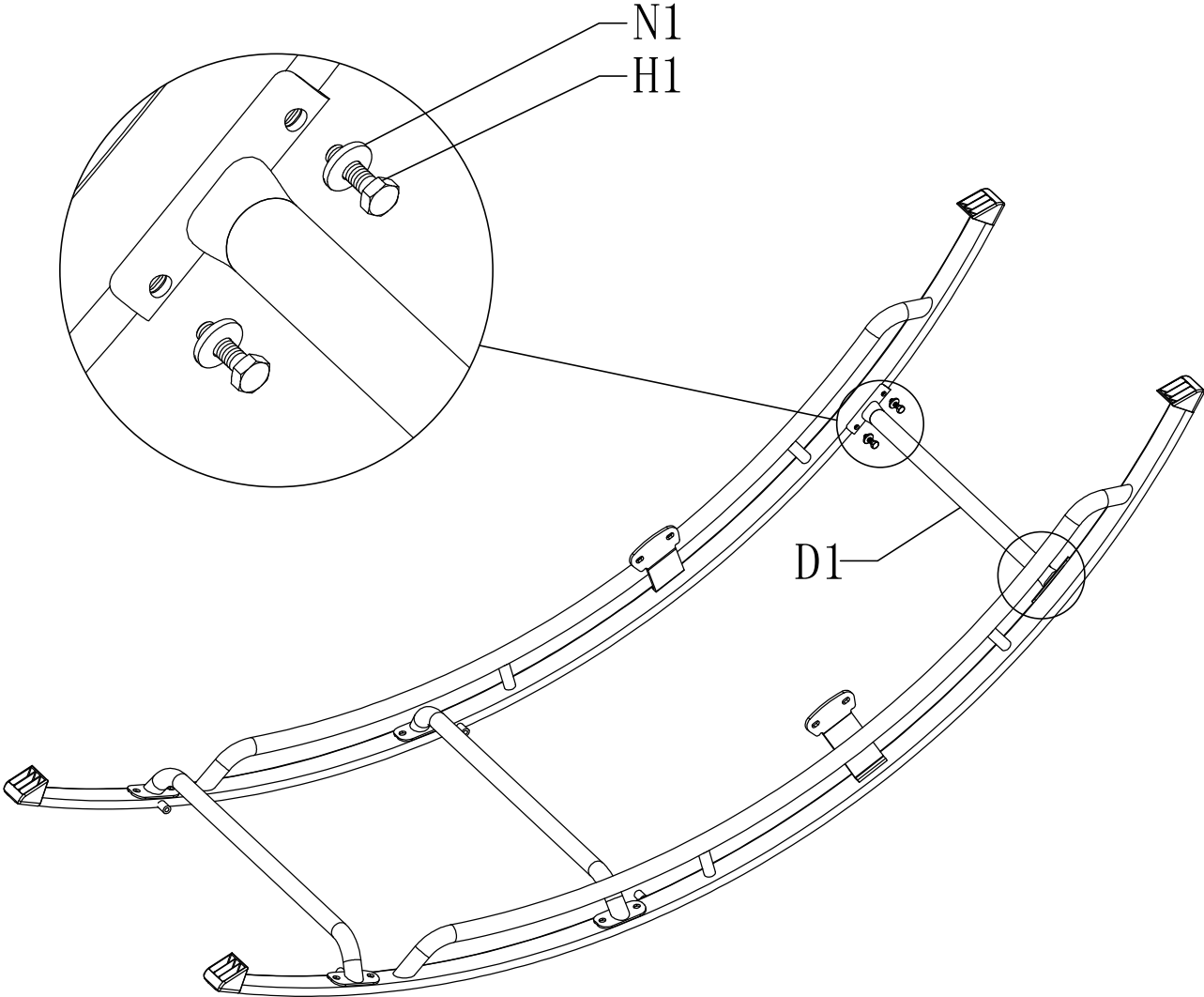

**WARNING:** Please REFRAIN from fully tightening the screws until all of them have been properly positioned.

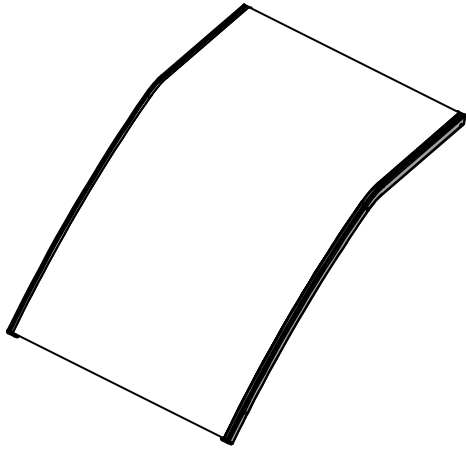

Chair Plate

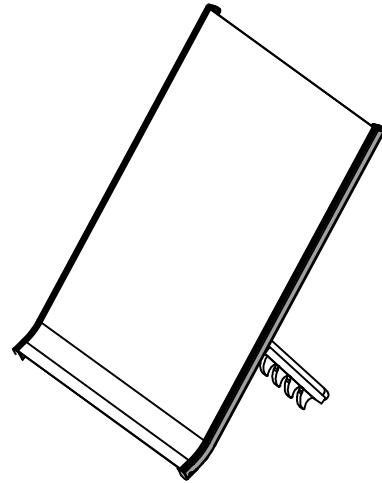

Backrest

**⚠ Warm Tip:**

Before assembling the chair plate and the backrest, please confirm the edge of the chair plate is as smooth as the backrest.

Only the above tip is confirmed, the assembly could be continued to avoid further inconvenience.

Anything unclear, please feel free to contact customer service.



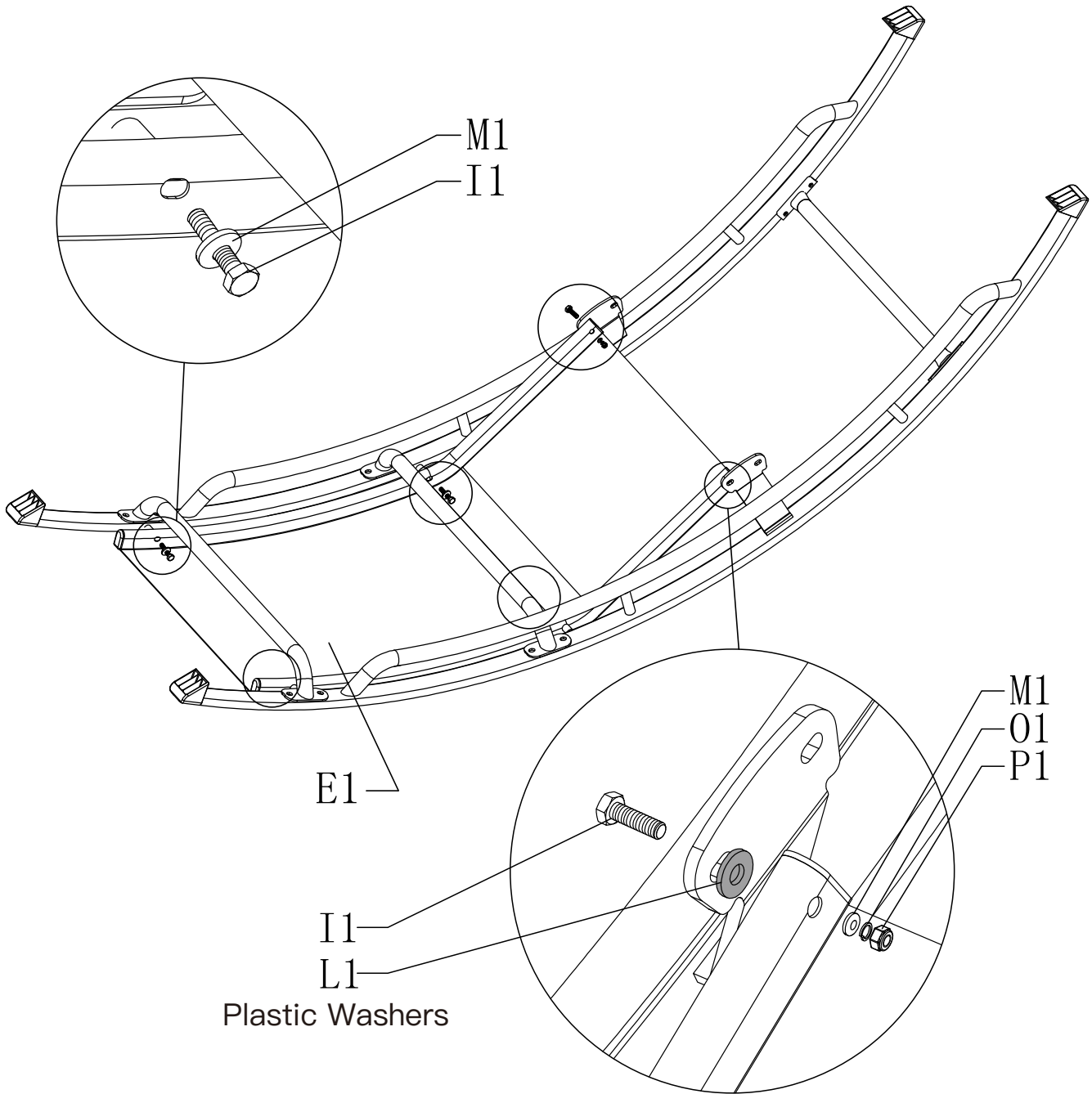

		 M6*35		 Metal Flat Washers (Large Size)		 Plastic Washers		 Spring Washers	
E1	1PCS	I1	6PCS	M1	6PCS	L1	6PCS	O1	6PCS

**Step 3:**

Assemble the chair plate (#E1) to the finished frame with hardware (#I1, M1, L1 and O1) as shown below.

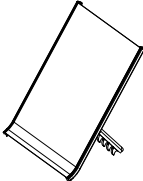
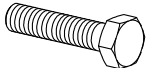

**WARNING:** Please REFRAIN from fully tightening the screws until all of them have been properly positioned.

		 M6*35		 Plastic Washers		 Metal Flat Washers (Large Size)		 Spring Washers	
F1	1PCS	I1	2PCS	L1	2PCS	N1	2PCS	O1	2PCS

**Step 4:**

As shown in the picture, secure the backrest #F1 onto the finished frame, using the hardware #I1, #L1, #N1 and #O1.

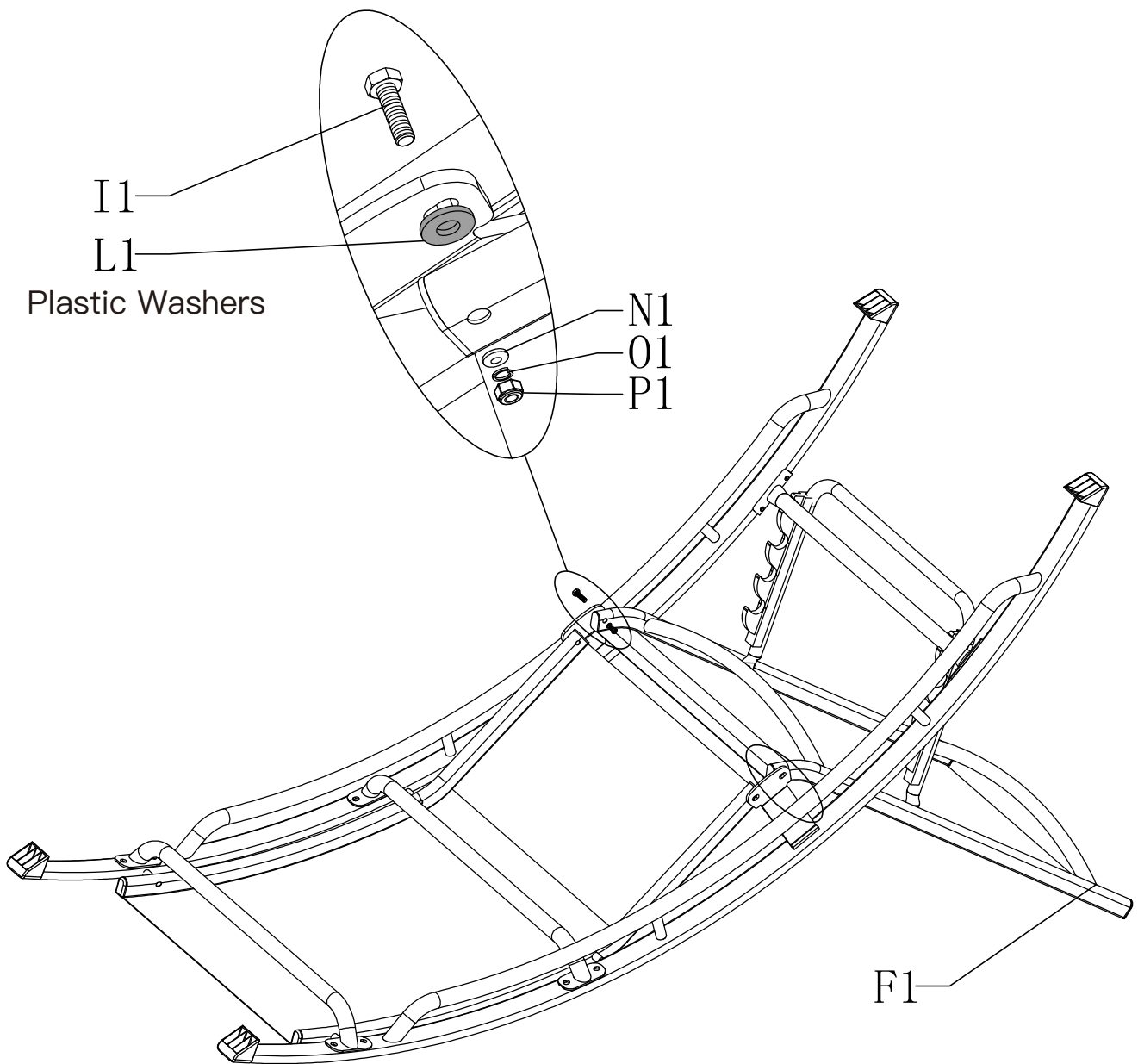

**WARNING:** Please REFRAIN from fully tightening the screws until all of them have been properly positioned.

Once all the parts and hardware are properly positioned, proceed to tighten all the screws. Afterward, cover the outer screws with the plastics #K1 and #J1 as shown below. Repeat these steps for the remaining chair.

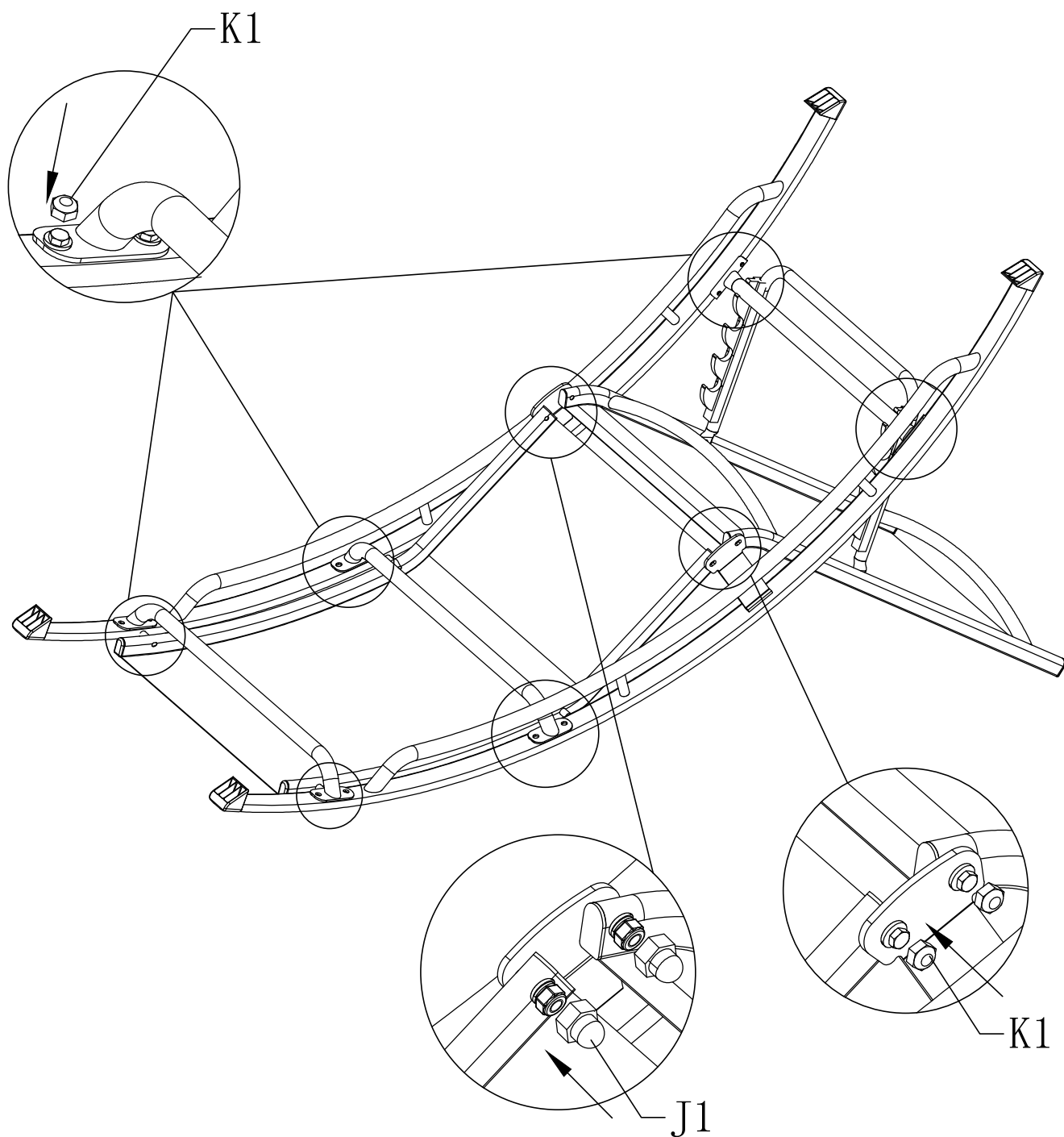

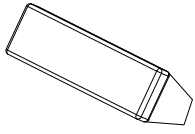

G1

1PCS

