

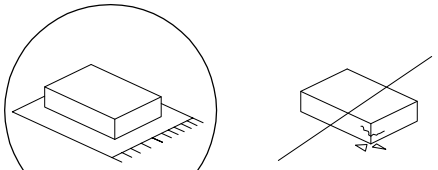

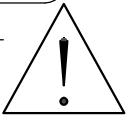

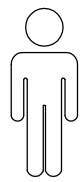

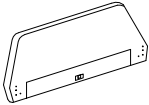

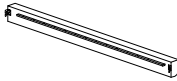
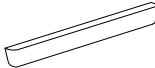

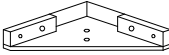

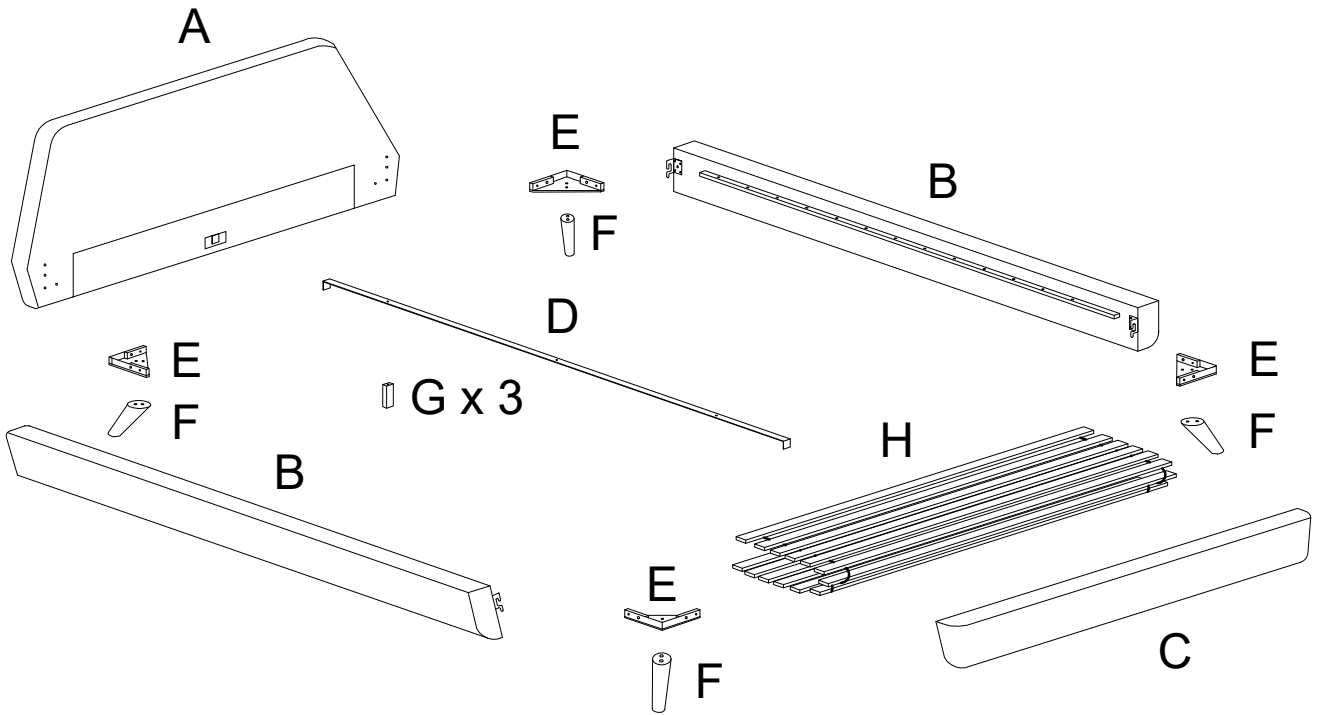

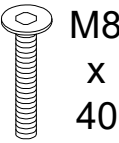
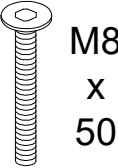
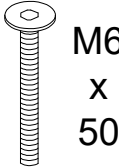

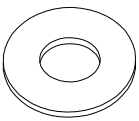
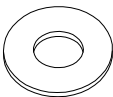
	<p>60'</p>	
		
		<p>2</p>

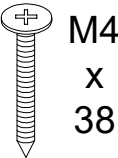
<b>A</b>	<b>B</b>	<b>C</b>	<b>D</b>	<b>E</b>	<b>F</b>
					
<b>x 1</b>	<b>x 2</b>	<b>x 1</b>	<b>x 1</b>	<b>x 4</b>	<b>x 4</b>

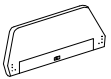

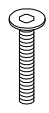

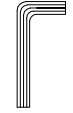
<b>G</b>	<b>H</b>	<b>I</b>	<b>J</b>	<b>K</b>	<b>L</b>
					
<b>x 3</b>	<b>x 1</b>	<b>x 8</b>	<b>x 8</b>	<b>x 25</b>	<b>x 41</b>
<b>M</b>	<b>N</b>	<b>O</b>	<b>P</b>	<b>Q</b>	<b>R</b>
					
<b>x 32</b>	<b>x 9</b>	<b>x 33</b>	<b>x 16</b>	<b>x 1</b>	<b>x 1</b>

1

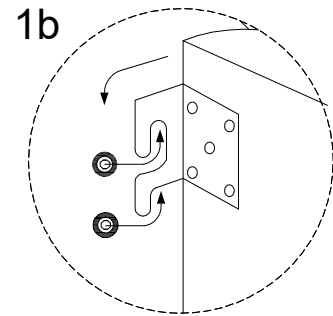
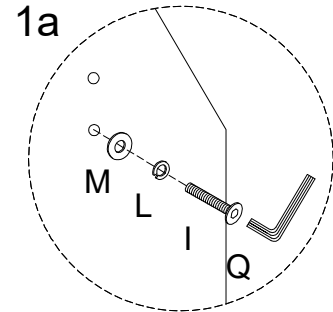
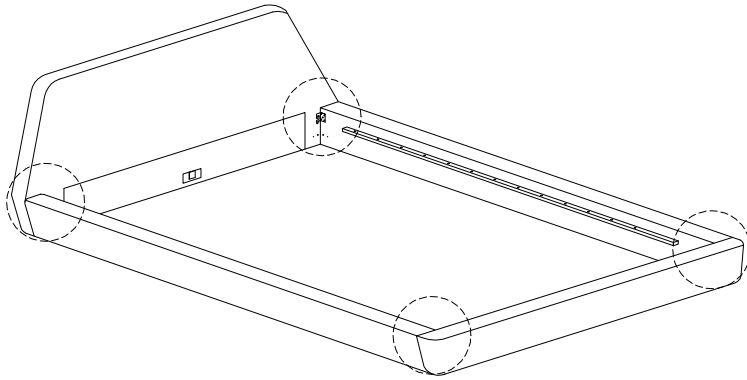
<b>A</b>  x 1	<b>B</b>  x 2	<b>C</b>  x 1	<b>I</b>  M8 x 40 x 8	<b>L</b>  x 8	<b>M</b>  x 8	<b>Q</b>  x 1
--	--	--	---	---	--	--



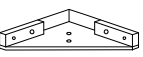
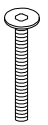

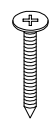
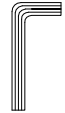
2

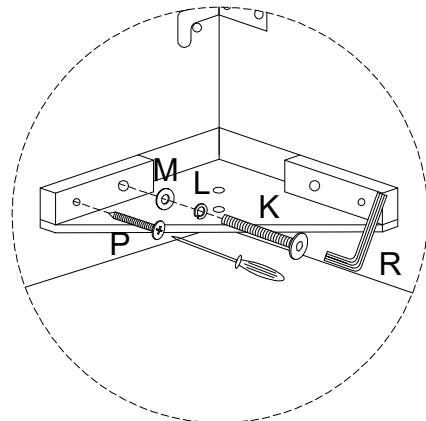
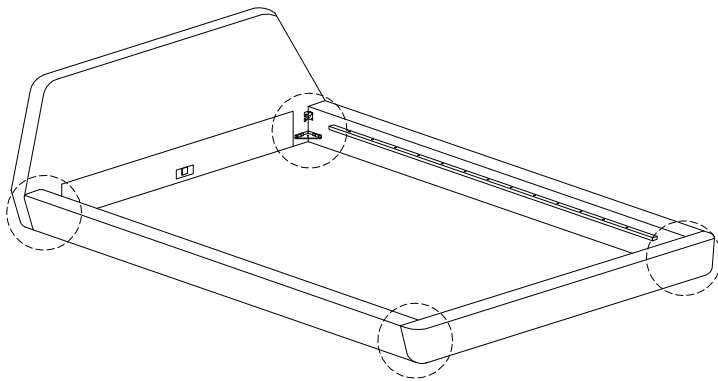
<b>E</b>  x 4	<b>K</b>  M6 x 50 x 16	<b>L</b>  x 16	<b>M</b>  x 16	<b>P</b>  M4 x 38 x 16	<b>R</b>  x 1
--	--	---	--	--	--



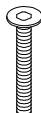

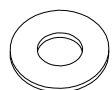
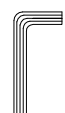

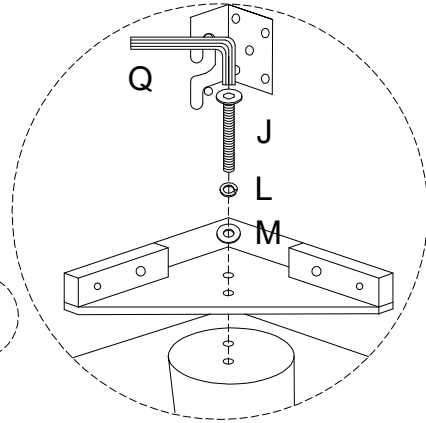
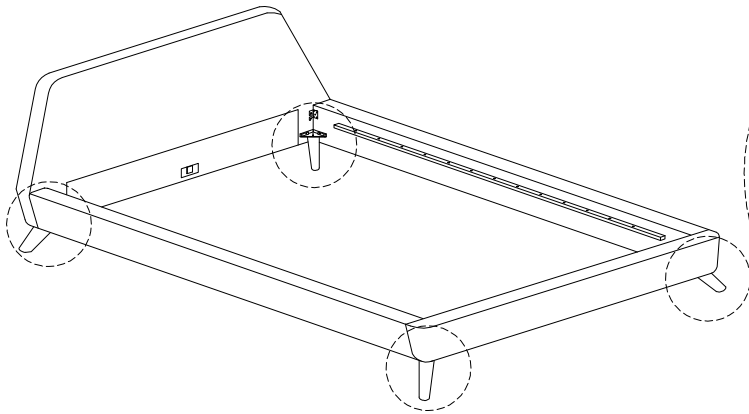
3

<b>F</b>  x 4	<b>J</b>  M8 x 50 x 8	<b>L</b>  x 8	<b>M</b>  x 8	<b>Q</b>  x 1
--	--	--	--	--

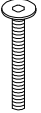

4

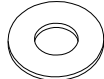
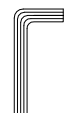
<b>D</b>  x 1	<b>G</b>  x 3	<b>K</b>  M6 x 50 x 3	<b>L</b>  x 3	<b>N</b>  x 3	<b>R</b>  x 1
--	--	--	---	--	--

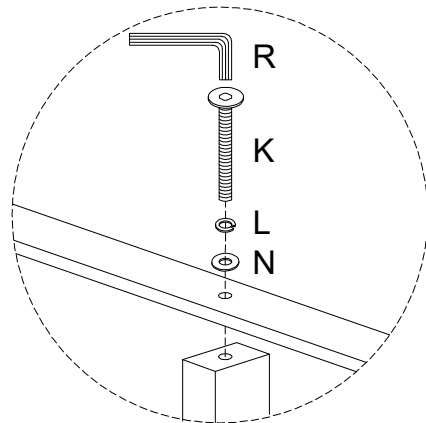
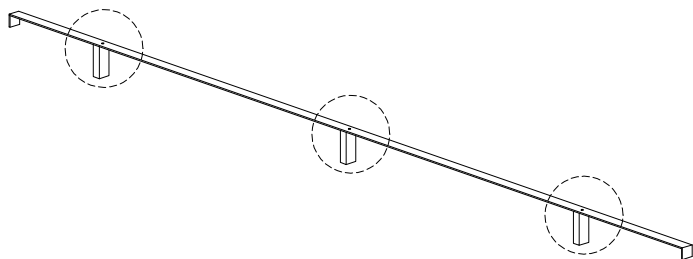

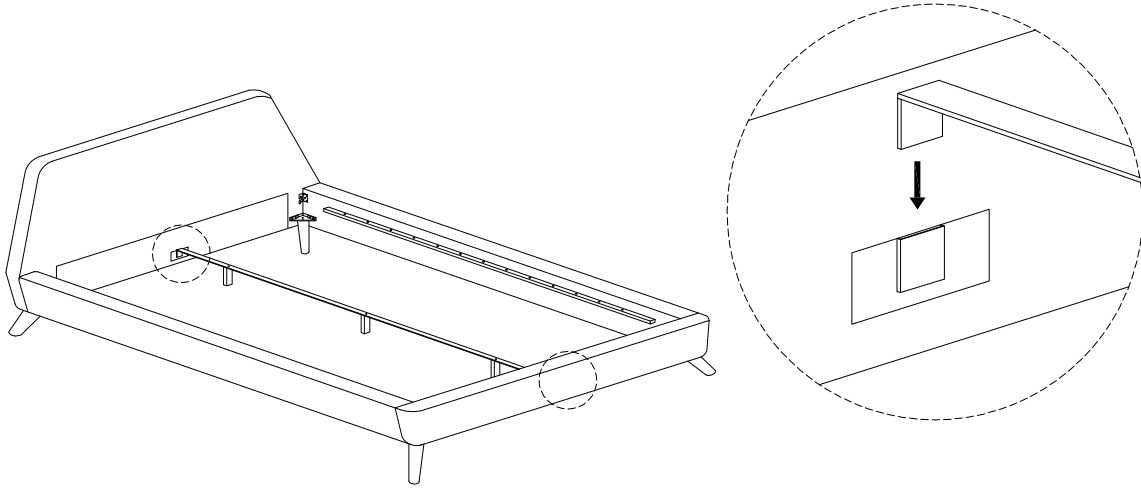

5

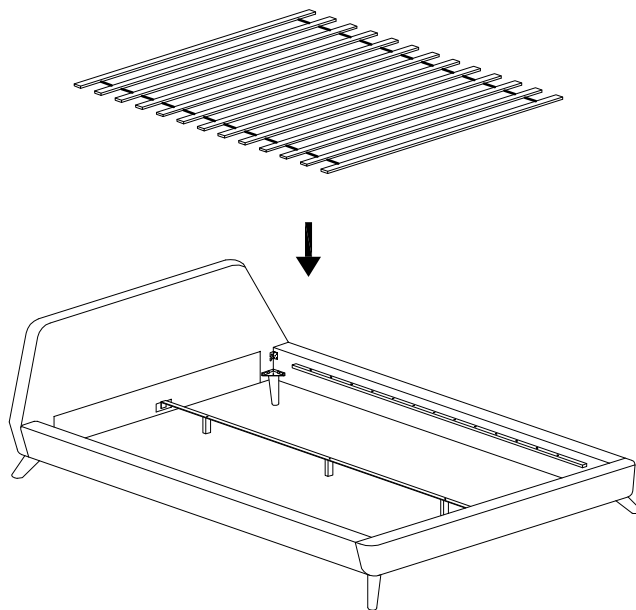
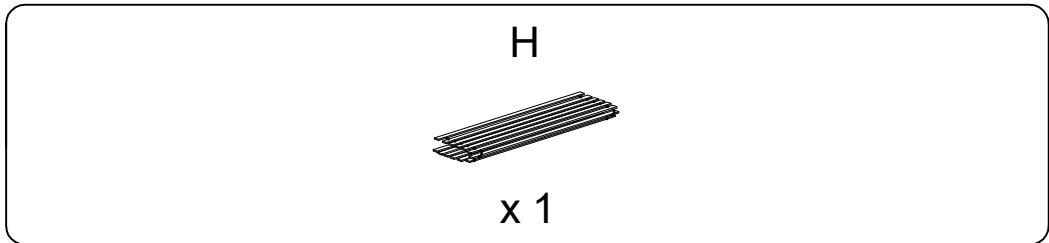

6

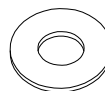
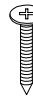
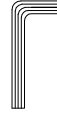

7

<b>K</b>  M6 x 50 x 6	<b>L</b>  x 6	<b>N</b>  x 6	<b>O</b>  M4 x 30 x 33	<b>R</b>  x 1
---	--	--	--	--

