

15 : 00

estimated assembly



2 or more

people required

Ok, let's
get started!



- Put on mood music!
- To prevent damage to product, use the clean side of package carton or rug as working surface
- In the event of missing or damaged parts, delivery problems etc., please reach out to our team. We will be happy to fix the problem!

care guide

- Clean regularly with a soft and dry cloth.
- To protect finish, avoid use of abrasive cleaners.
- Wipe up spills immediately. Please!

ⓘ **While assembling the product, tighten the bolts up to 50%. Once all parts are in place, only then fully tighten the bolts.**



product parts

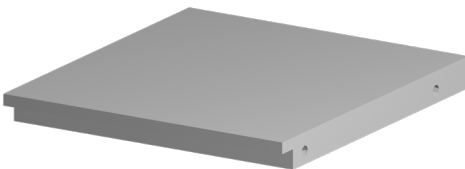
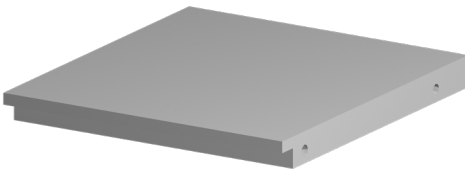
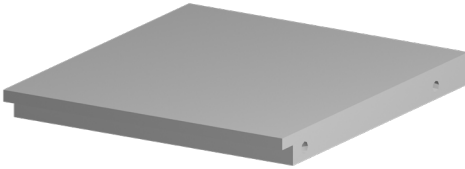
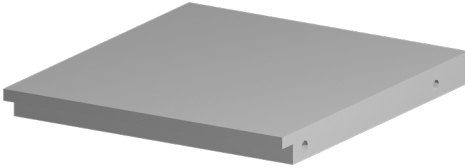
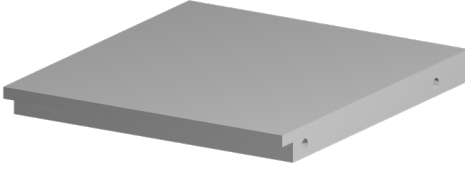

A
Shelf
x5



B
Frames
x2

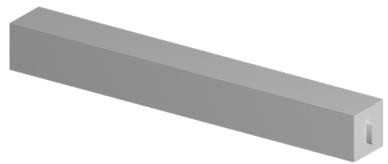

C
supporting slat
x1

what's included

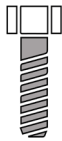

(D)-Bolt
M8x50mm
x20



(E)-Lock Washer
Ø13mmx Ø8mm
x20



(F)-Washer
Ø18mmx Ø8mm
x20

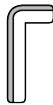

(G)-Allen key
x1

assembly instructions

Friendly Tip: Take a deep breath going in. This may be a tricky part, but nothing too overwhelming. Just follow these steps to the T and the outcome will be worth it!



- ⓘ While assembling the product, tighten the bolts up to 50%. Once all parts are in place, only then fully tighten the bolts.

step 1:

Start by placing the frames (B) & (C) on the floor.

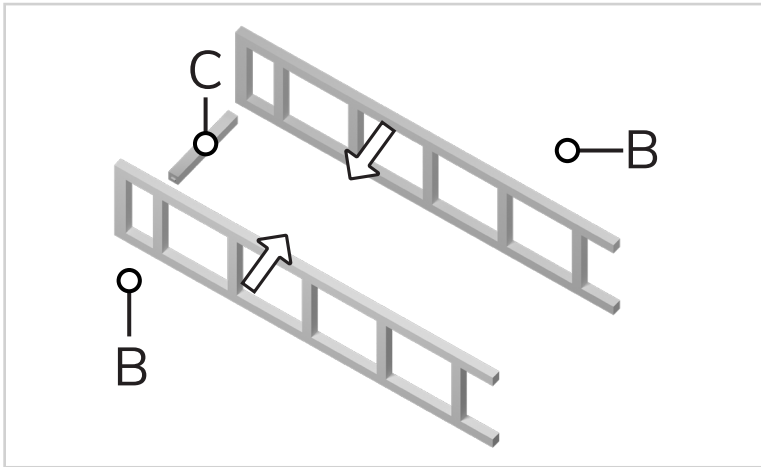

step 2:

Taking this image as reference, align the supporting slat (C) with the slots on frames (B) and fix it in place.

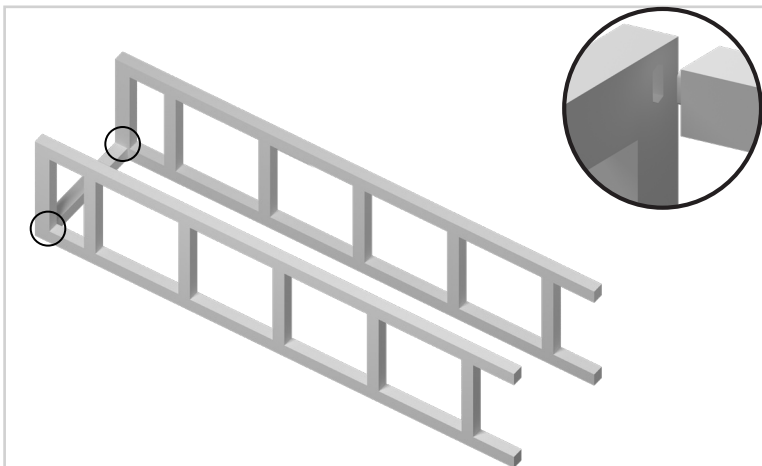

step 3:

Now, align the shelves (A) with the slots on the frames (B) as shown in the image below.

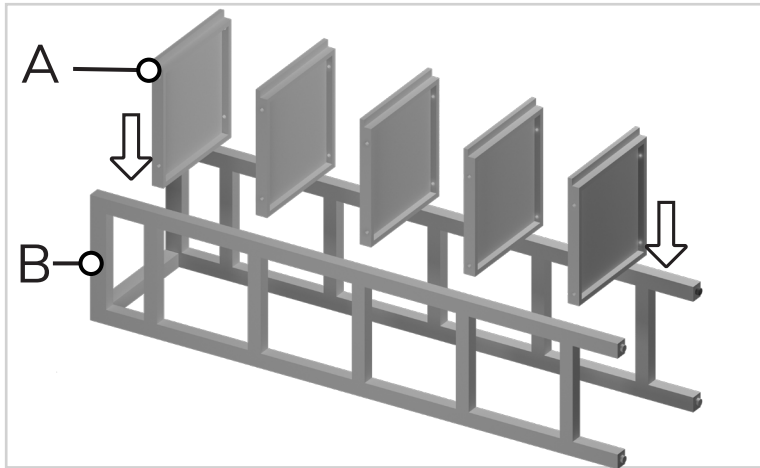

step 4:

Once aligned with the slots on frames (B), start securing it using washer (F), lock washer (E), and bolt (D). Tighten all points using allen key (G). Repeat steps with remaining shelves (A).

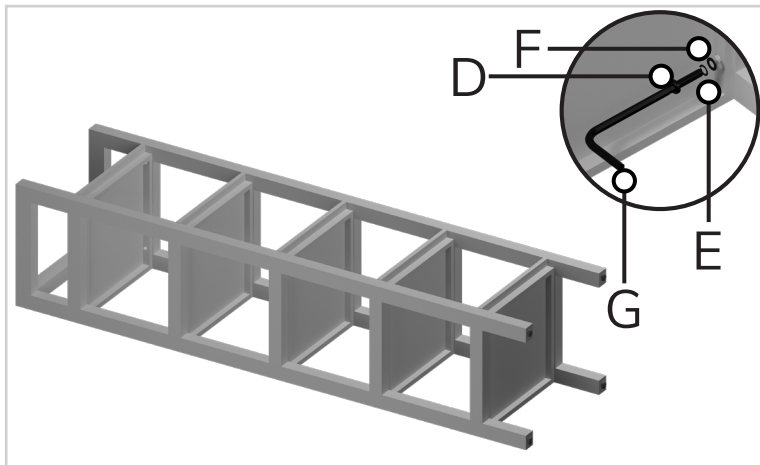

step 5:

Now, if required, adjust the leveller according to the floor.

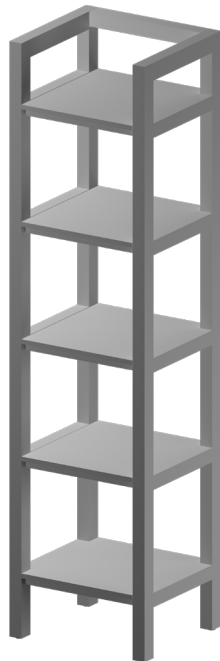
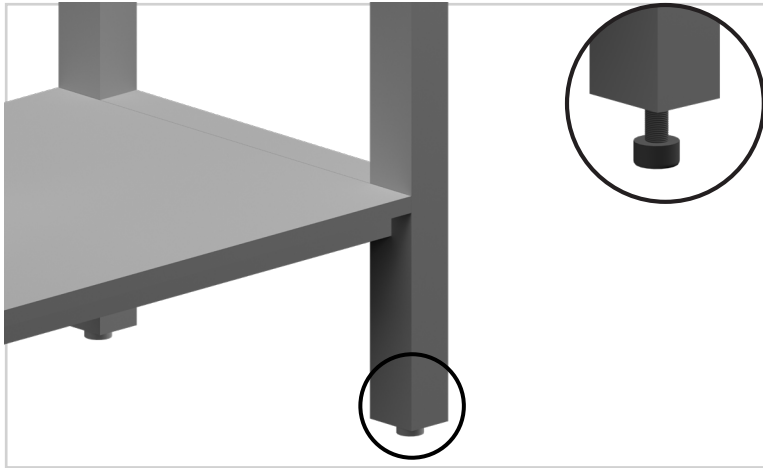

Voila! Your bookcases is now assembled and secure!

you've
got
a home
with us

