

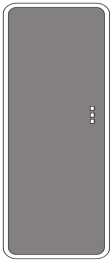









<div style="border: 1px solid black; padding: 5px; display: inline-block; font-size: 24px; font-weight: bold;">1751</div> 	 <b>2 pcs</b> <small>(4x45mm)</small>	 <div style="margin-top: 10px;"> <p><b>Touch button description</b></p> <div style="display: flex; align-items: center; margin-bottom: 10px;">  <div style="margin-left: 5px;">1. ON/OFF</div> </div> <div style="display: flex; align-items: center; margin-bottom: 10px;">  <div style="margin-left: 5px;">2.RGB Dynamic Mode</div> </div> <div style="display: flex; align-items: center;">  <div style="margin-left: 5px;">3.Static Light Mode</div> </div> </div>
	 <b>4 pcs</b> <small>(6x12mm)</small>	
	 <b>2 pcs</b> <small>(4x45mm)</small>	
	 <b>2 pcs</b> <small>(320x45x12mm)</small>	
	 <b>2 pcs</b>	
	 <b>1 pcs</b>	

**Assembly instructions for door and wall mounting**

**Option 1 Step 1**

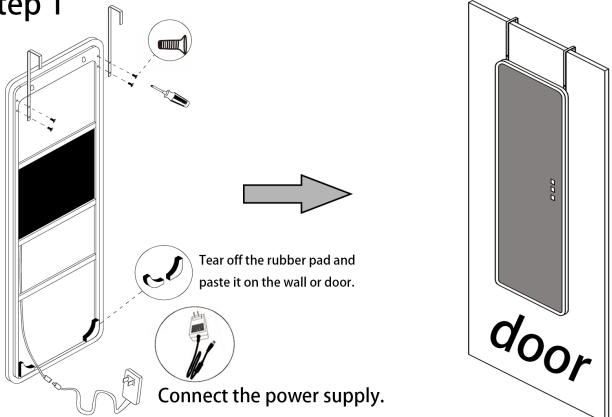

Tear off the rubber pad and paste it on the wall or door.

Connect the power supply.

**Option 2 Step 1**

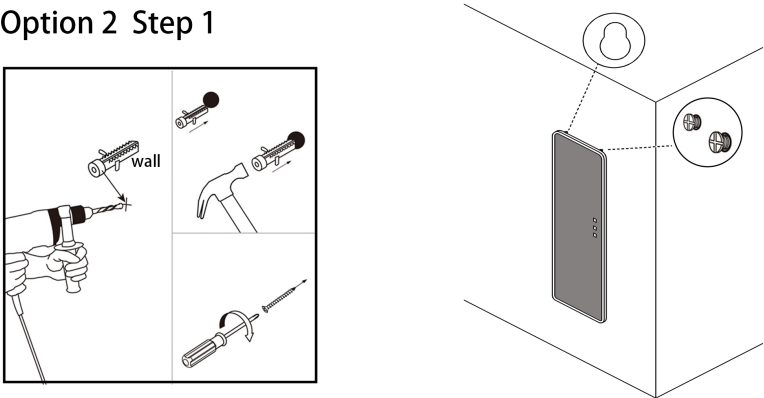

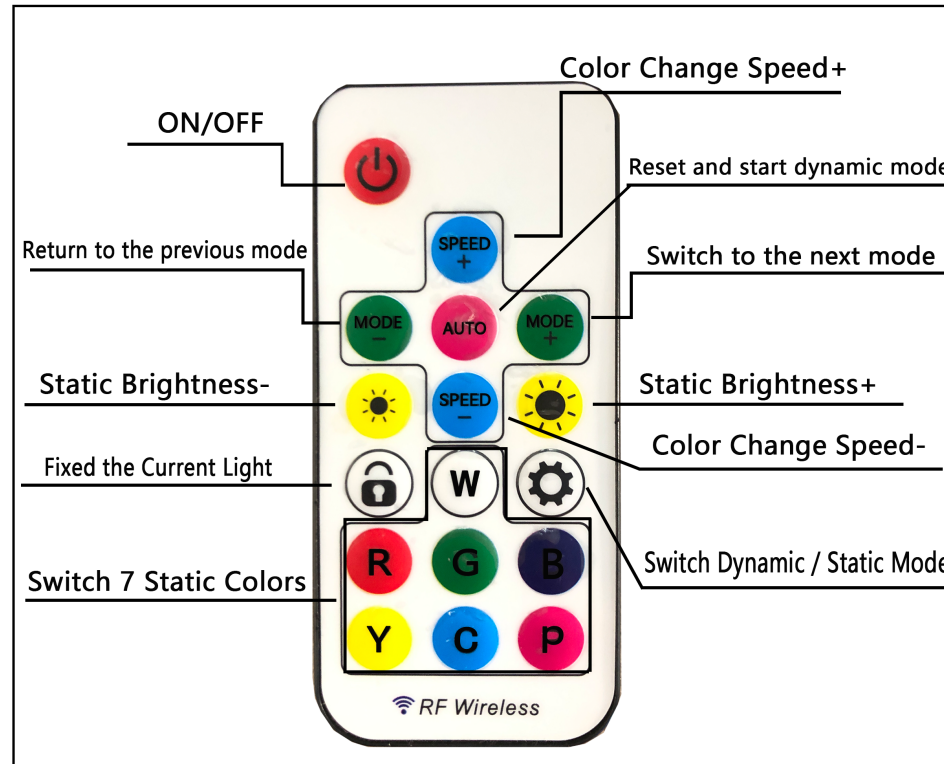

## LED Lights Controller-use instructions

Remote Battery: CR205 3V

How to use the controller?

1. After inserting the DC power adapter, you can use the remote control to control the lights. Press The "on /off" key to turn on the light and it will enter the static light mode.
2. There are 7 RGB Dynamic Modes. You can press the "MODE+/- " key to choose dynamic colors that you preferred and press the " Speed+/-" key to adjust color change speed.
3. There are 7 static colors: White / Red / Green/ Blue / yellow / ice blue/ pink light. You can press the "Brightness +/-" key to adjust the brightness.
4. You can press the "lock" key to fix the color you like. When you press the "Switch Dynamic /Static Mode" ket, the light will change between dynamic mode and static mode.