











Assembly Instruction for 48" ROUND DINING TABLE ESPRESSO/FAUX MARBLE

Thank you for purchasing this quality product. Be sure to check all packing materials carefully for small parts, which may have come loose inside the carton during shipment. Identify and count all items and compare with the parts list and/or hardware list shown below.

NO.	PART DESC	SKETCH	Q'TY
A	Table Top		1pc
B	Connector Panel		4pcs
C	Middle Shelf		1pc
D	Leg		4pcs

NO.	HARDWARE DESC	SKETCH	Q'TY
1	Lock Washer (Ø5/16 ")		8pcs
2	Flat Washer (Ø5/16 ")		8pcs
3	Short Bolt (Ø5/16 "x65mm)		8pcs
4	Long Bolt (Ø5/16 "x30mm)		4pcs
5	Short Bolt (Ø1/4 "x25mm)		8pcs
6	Allen key (4mm)		1pc

STEP : 1

Fully Tigthen the bolt

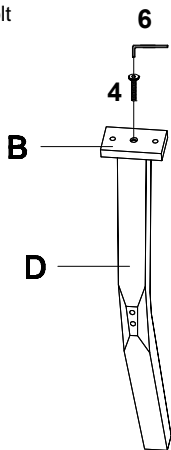

STEP : 2

Install 3 of legs ,then install shelf and last leg

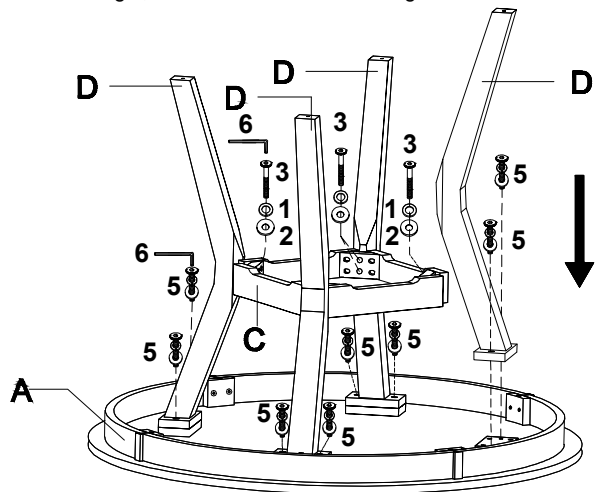

Don't tighten the bolts untill last step

COMPLETED

