

## **ITEM NO.DCTL1192-ACR/ DCTL1192-BLK**

---

### **NOTE:**

This brochure contains IMPORTANT safty info. Please read and keep for future reference.

---

# MAINTAINANCE AND WARNING

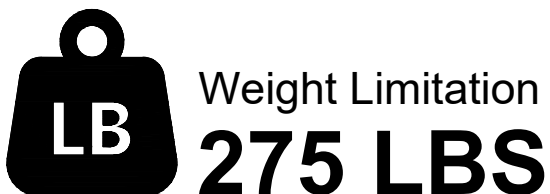

- 1.Keep furniture away from heat sources.
- 2.Do not clean furniture with harsh cleaner or polishes.Do not use detergents,solvents,abrasives,spray packs or leather cleaner. Use non-color mild soa with warm water to clean spills(Mix 1:10 soap to water).
- 3.Do not place furniture under direct sunlight,material will possibly fade over time.
- 4.Do not use on site dry cleaning machine.Children should not climb or jump on the furniture.
- 5.Do not write on furniture that is not protectedby a padded barrier.
- 6.Not for commercial use,only for residential use.

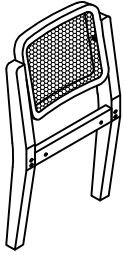
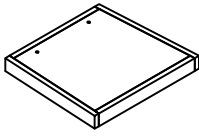
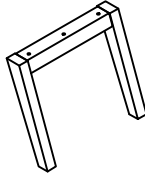
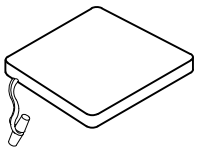

# PARTS LIST

A	x1	B	x1	C	x1	D	x1
							

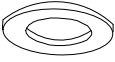
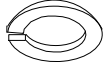
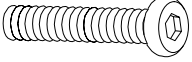
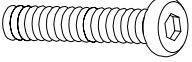
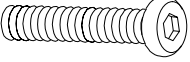
# HARDWARE LIST

#1	x9	#2	x9	#3	x2	#4	x4	#5	x3	#6	x1
											
Ø1/4x19mm		Ø1/4x13mm		Ø1/4x35mm		Ø1/4x75mm		Ø1/4x40mm		Ø10x30mm	

# TOOL LIST

#7	x1
	
M4	

# HARDWARE SPARE LIST

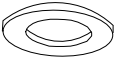
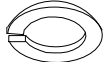
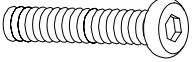
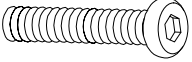
#1	x1	#2	x1	#4	x1	#5	x1
							
Ø1/4x19mm		Ø1/4x13mm		Ø1/4x75mm		Ø1/4x40mm	

# ASSEMBLY INSTRUCTIONS

## STEP- 1



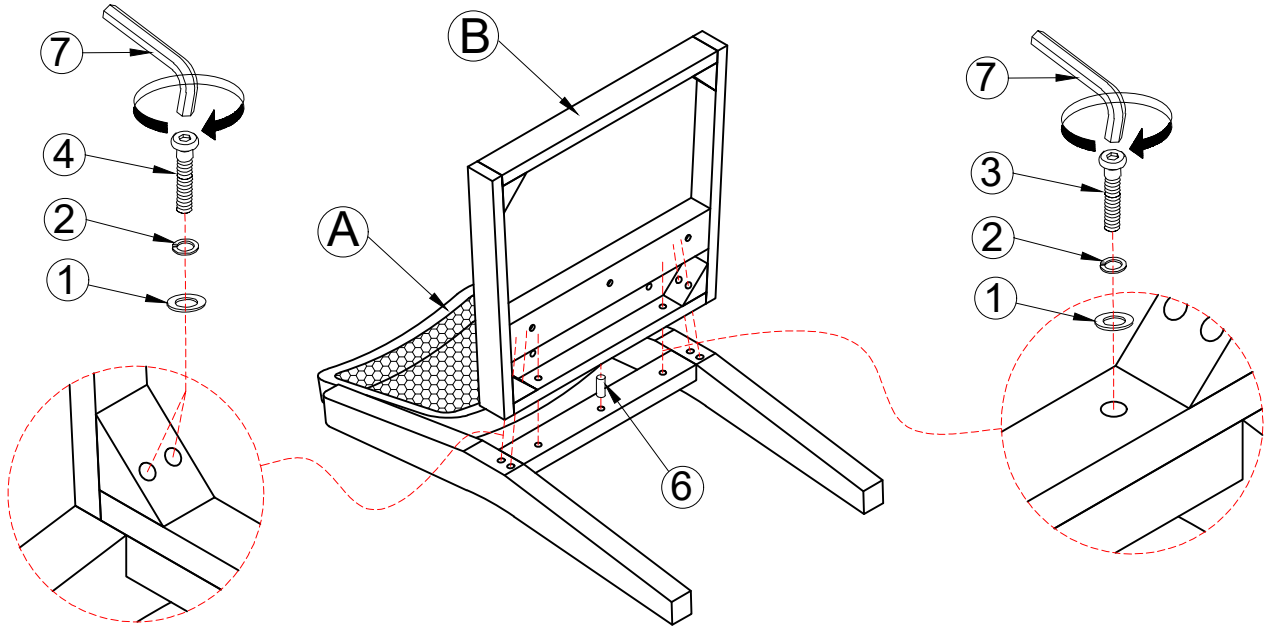

Turn the back chair (A) down on to a clean, soft surface. Attach wood pegs(6) on back chair (A). Attach seat frame (B) on the back chair (A) by using Flat washer (1), Lock Washer (2), Bolt (3), Bolt (4) with Allen Key (7) . (Don't tighten bolt until at step 2).



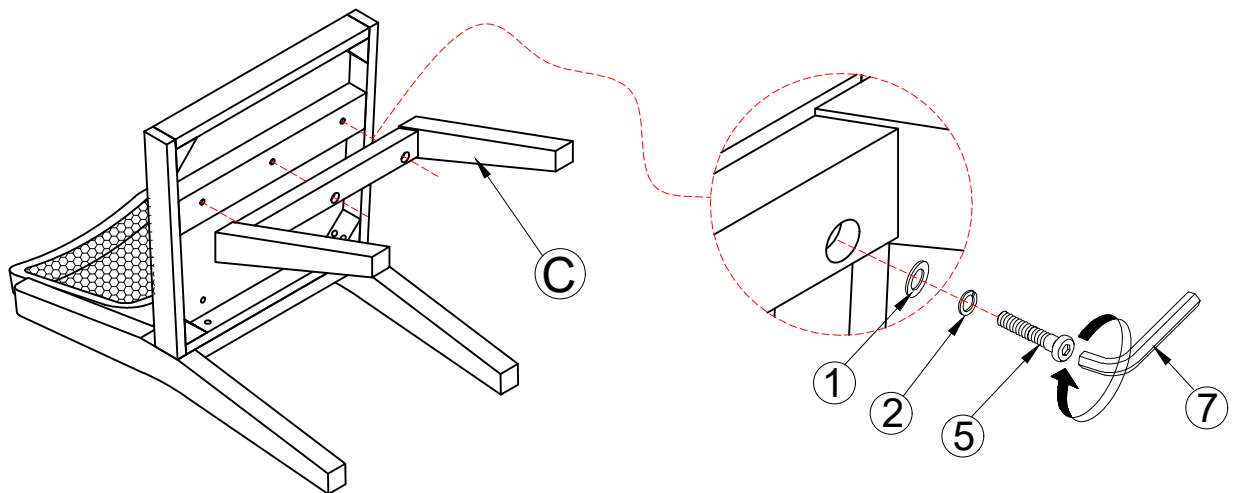

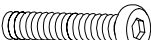

## STEP- 2

Attach front leg frame (C) on the seat frame (B) by using Flat washer (1), Lock Washer (2), Bolt (5) with Allen Key (7) .



1		x9
2		x9
3		x2
4		x4

5		x3
6		x1
7		x1

 After installation, please keep the chair balanced, tighten all bolts.

# ASSEMBLY INSTRUCTIONS

## STEP- 5

Attach seat cushion (D) on the chair .

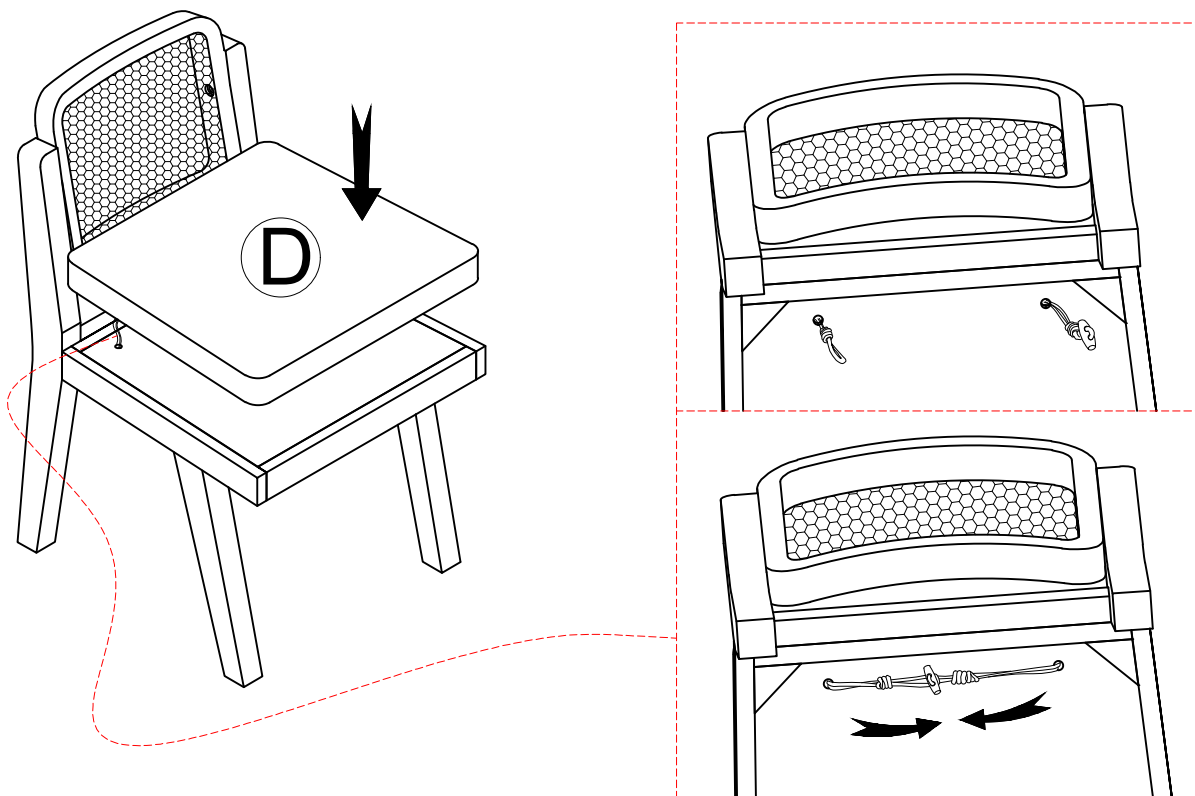

During the using processing time, it's loose, please use Allen key to tight it.

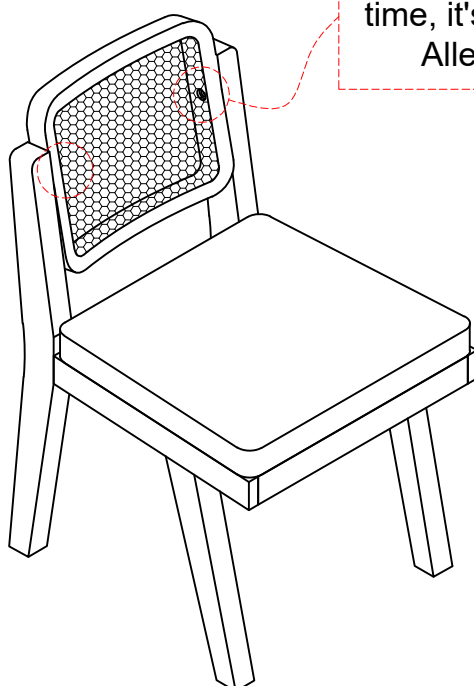

# WARRANTY

1. We strive to offer high-quality products, and we also try our best to satisfy each and every customer that orders from us with product or service as needed.
2. We provide 30 days warranty starting from the time you receive the item. Each customer must provide a record of their order such as the order number, or item receipt for any items that are out of the warranty period you may also still receive.
3. Replacement parts by purchasing them with our company if they are available.

For return, please check the return policy with the retailer or market place you bought from.

Appreciate your purchasing from us.  
Pop up your life by our furniture piece!