

# ASSEMBLY INSTRUCTION

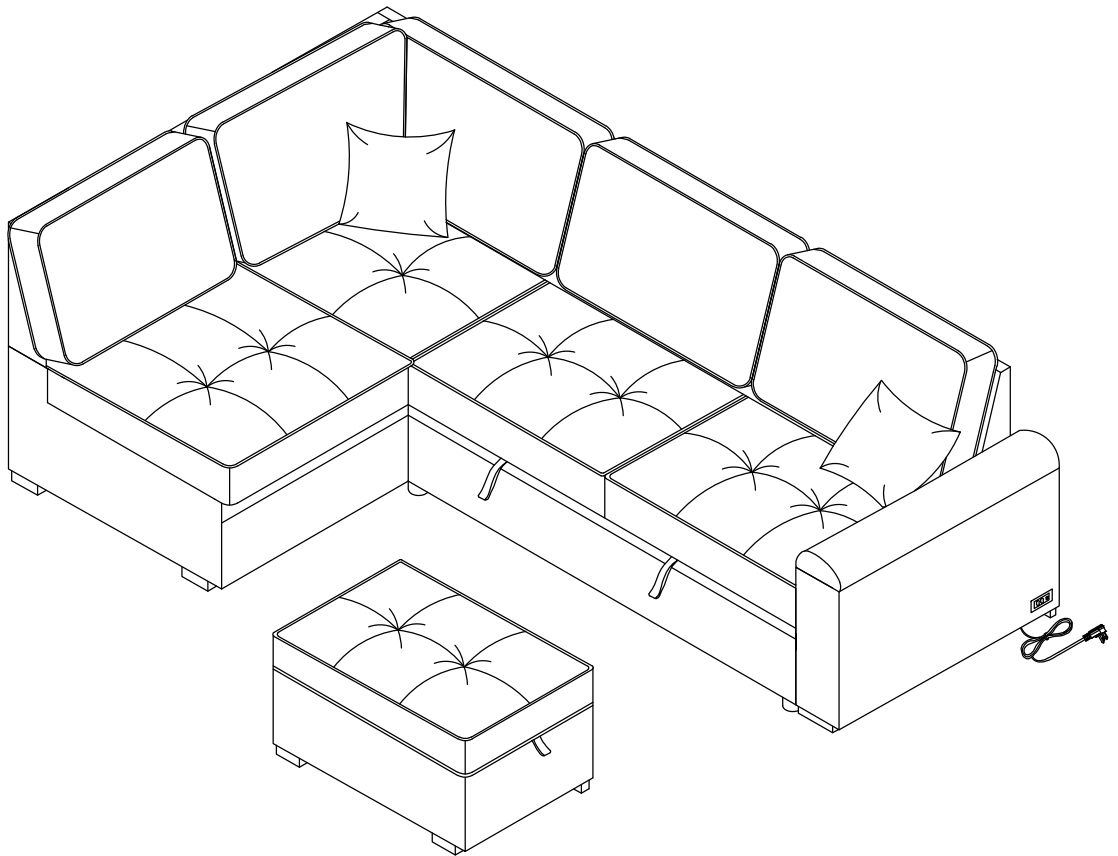

## PARTS

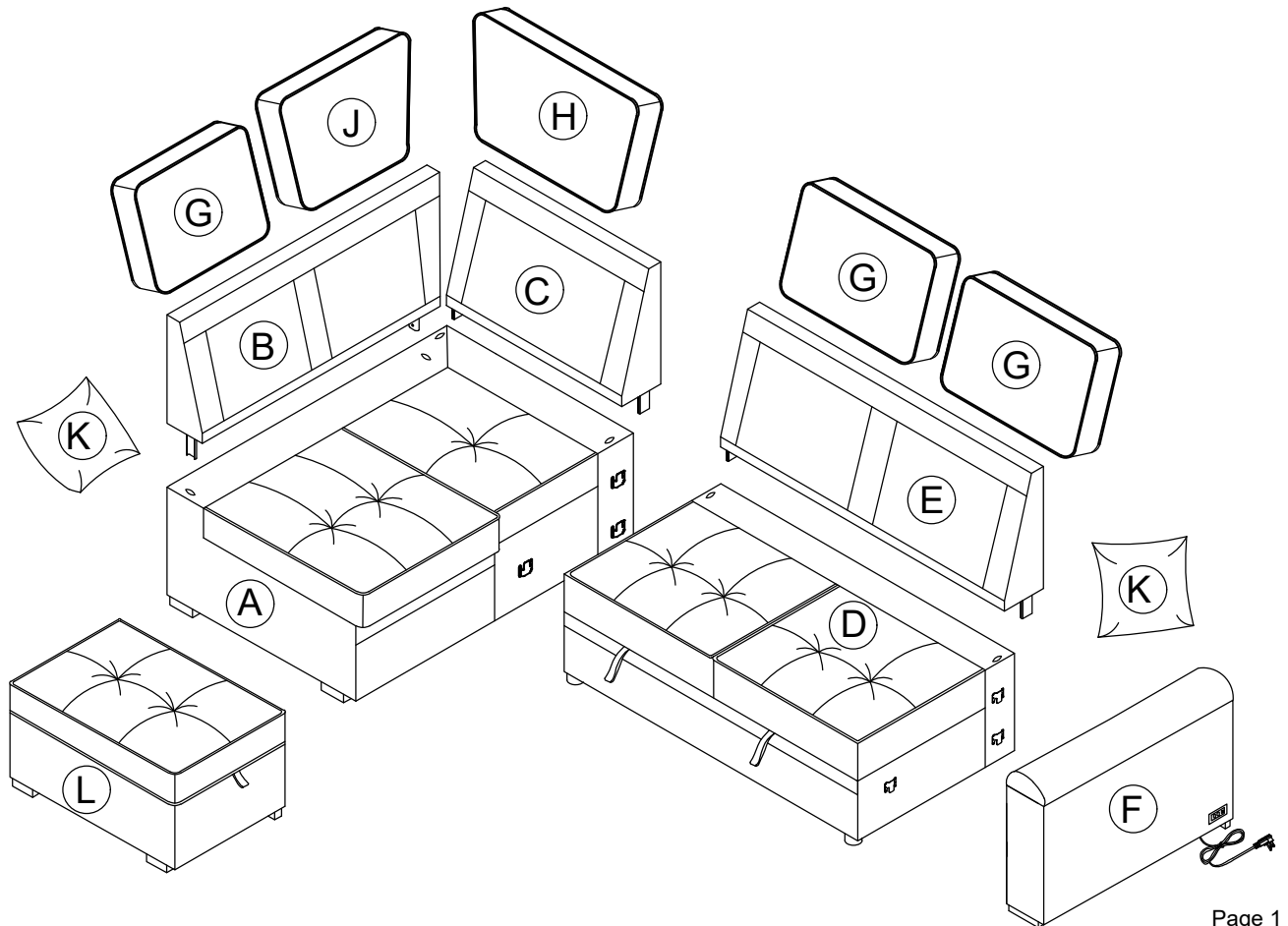

# PARTS LIST

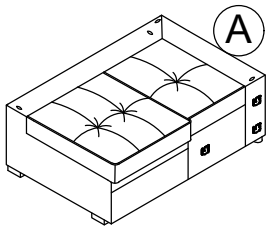

Chair Body X 1PC

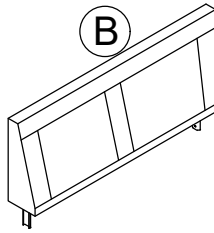

Long Back Frame X 1PC

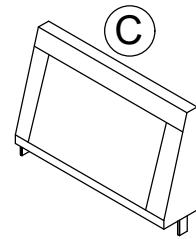

Short Back Frame X 1PC

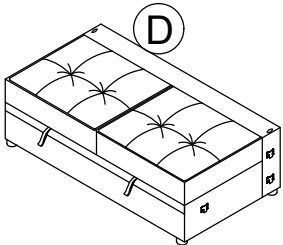

Loveseat Body X 1PC

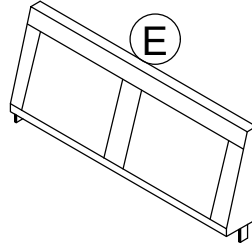

Loveseat Back Frame X 1PC

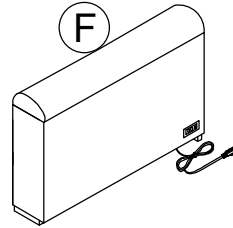

Arm X 1PC

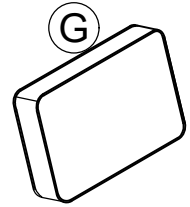

Back Cushion X 3PCS

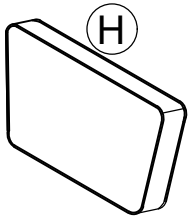

Back Cushion X 1PC

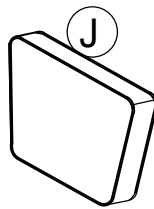

Back Cushion X 1PC



Pillow X 2PCS

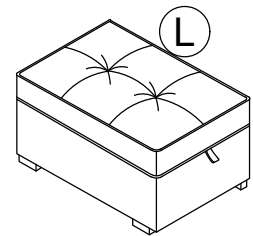

Otoman X 1PC

## STEP 1:

1.1 Attach B x1 with C x1 to A x1 .

1.2 Attach E x1 to D x1.

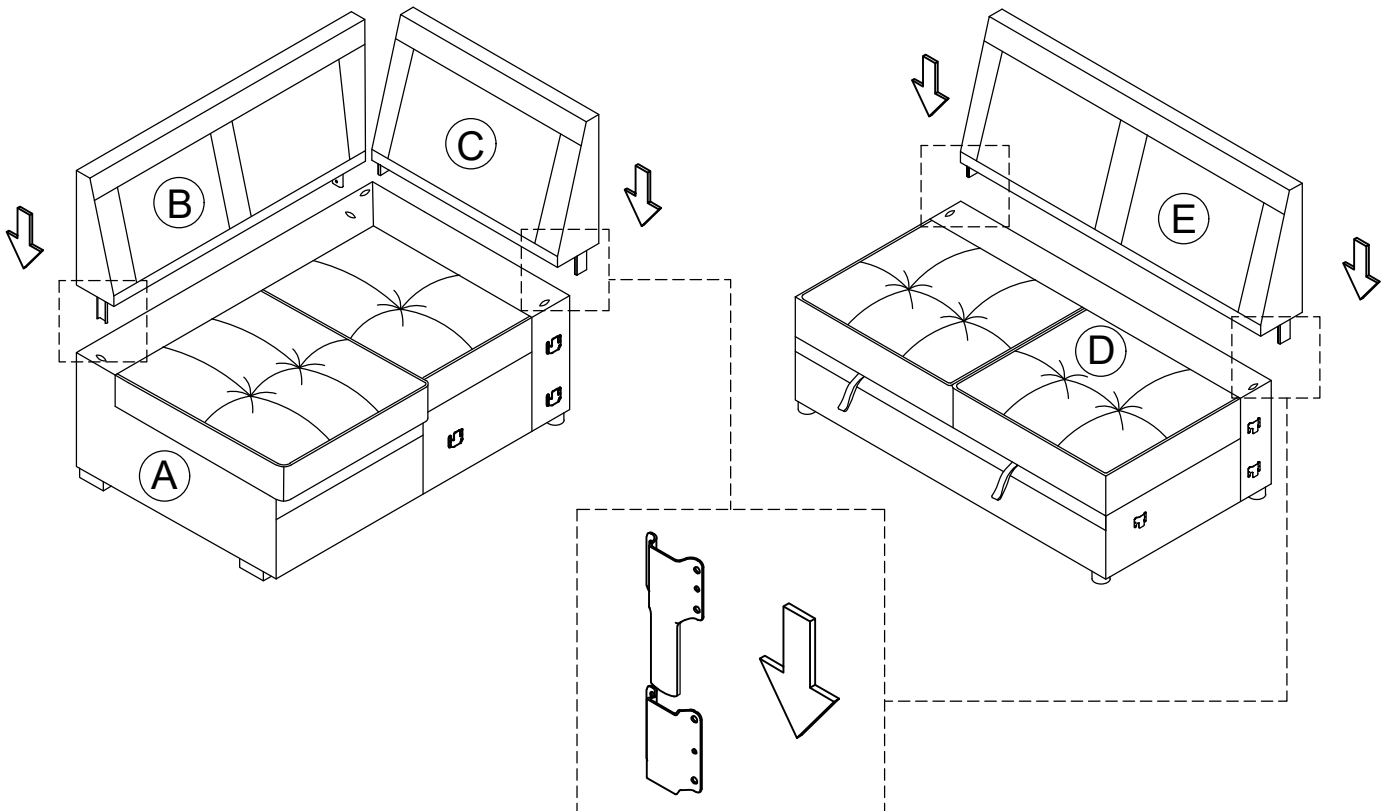

## STEP 2:

2.1 Attach F x1 with D x1 to A x1 .

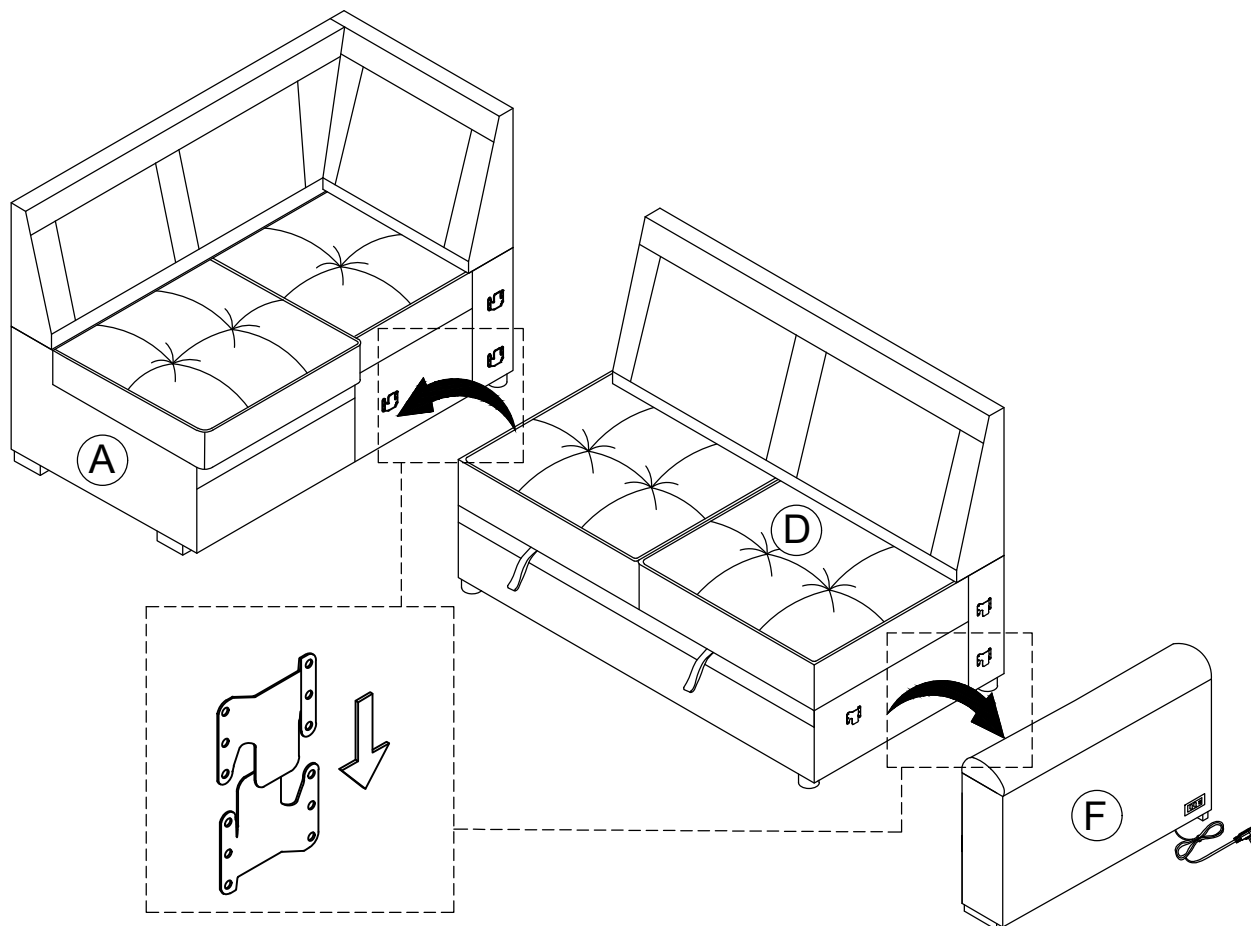

## STEP 3:

3.1 Attach G x1 with J x1 to B x1 .

3.2 Attach H x1 to C x1 .

3.3 Attach G x2 to E x1 .

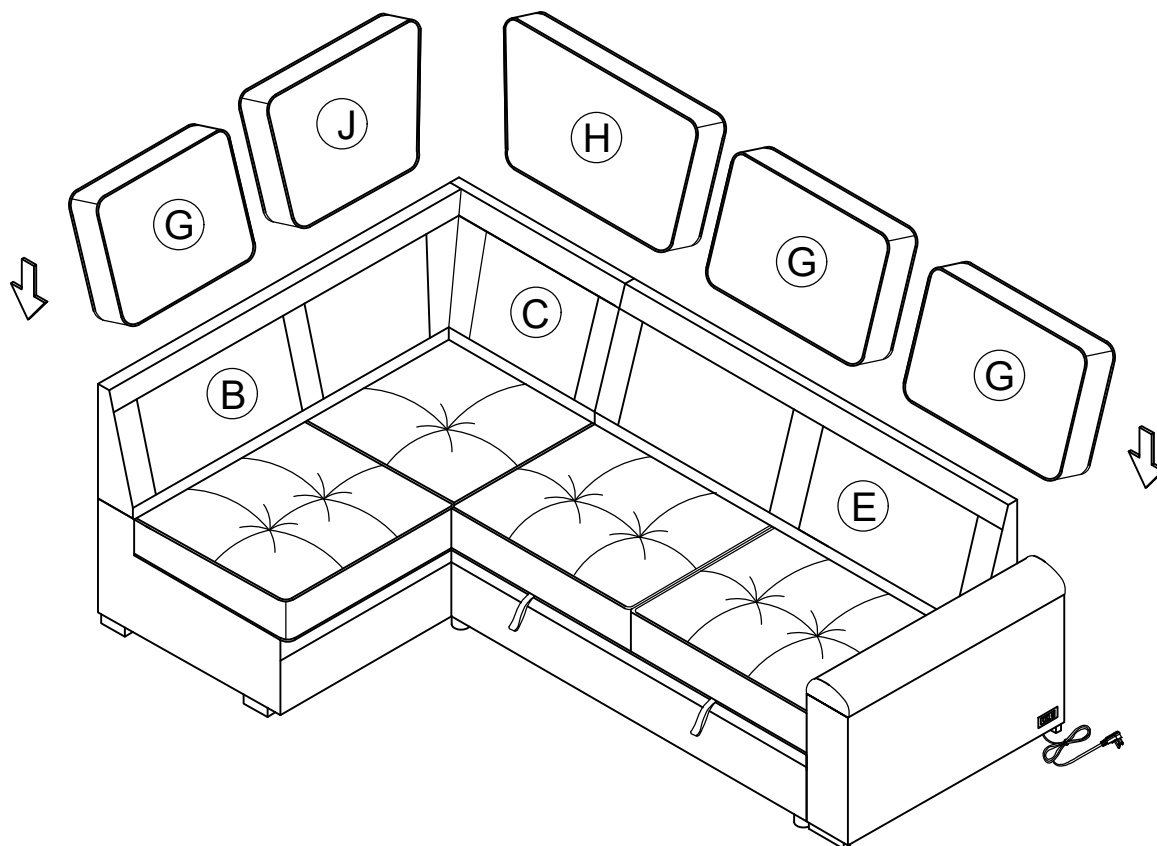

**STEP 4:**

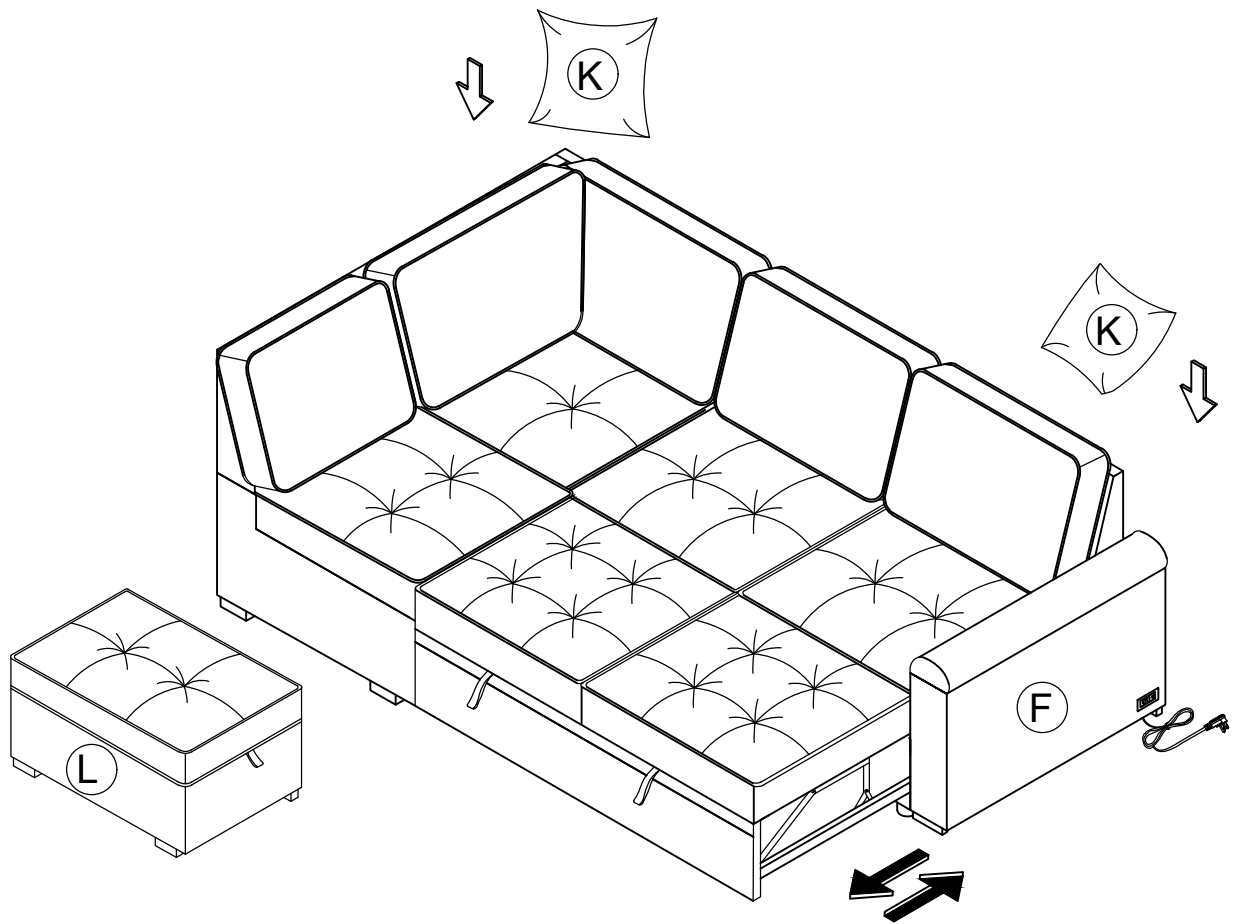

**STEP 5:**

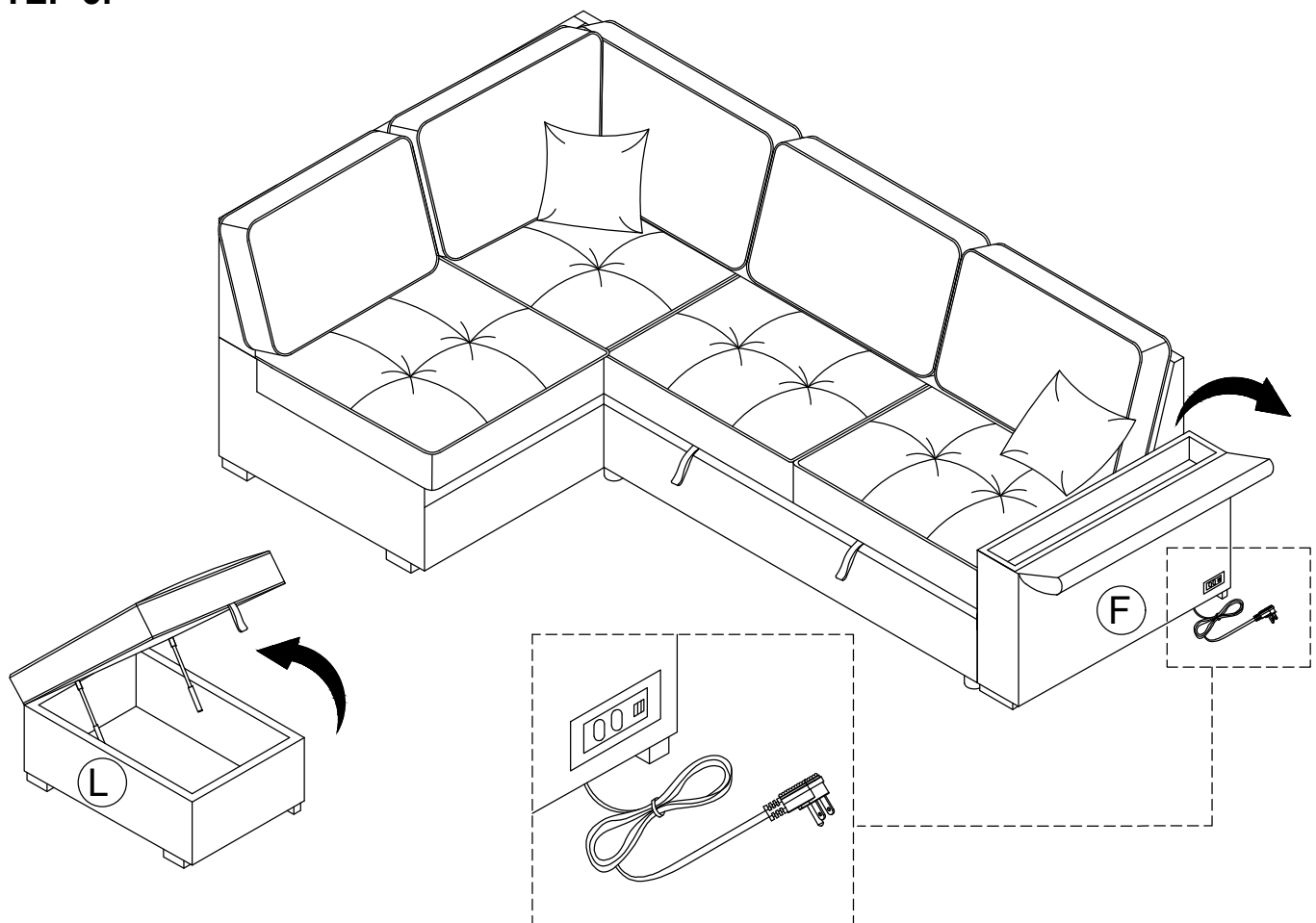

**COMPLETE**

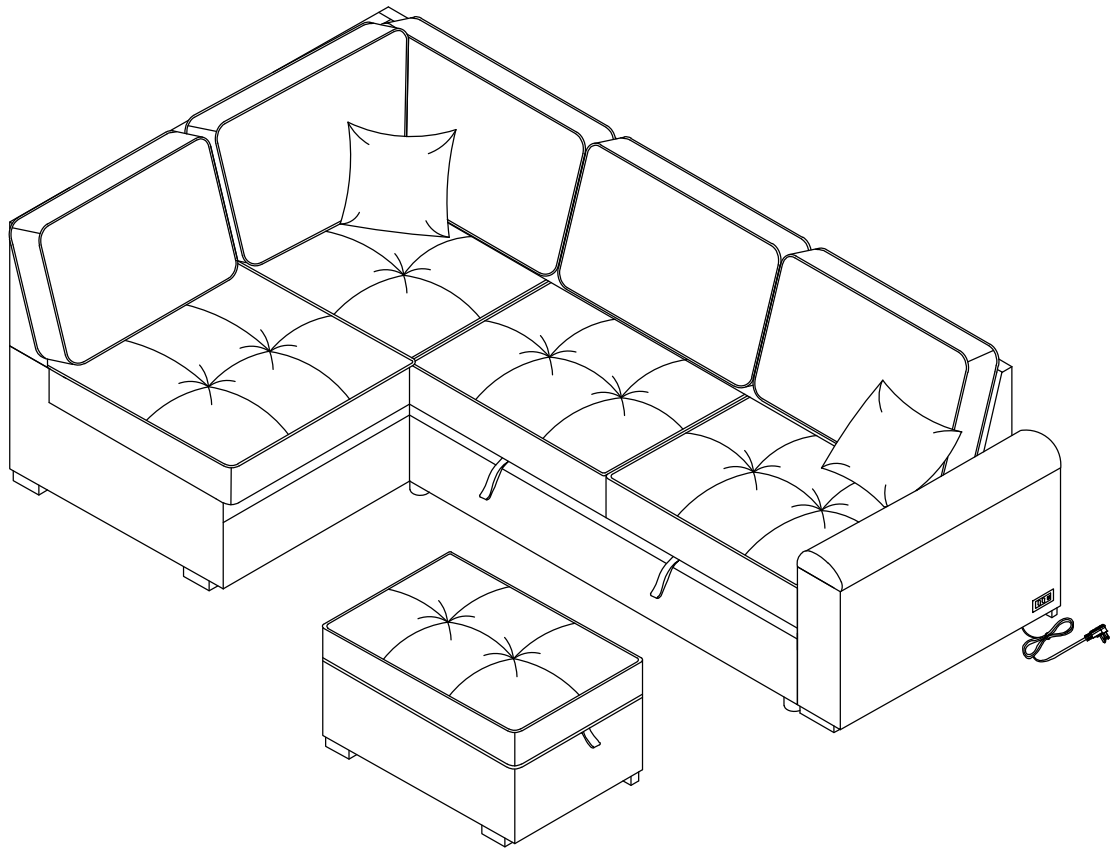

## Helpful Hints

- Your futon can transform between a Sofa.
- Move your new furniture carefully, with two people lifting and carrying the unit to its new location.
- Your furniture can be disassembled and reassembled to move.
- Clean the product with a soft damp cloth. DO NOT use harsh chemicals or abrasive cleaners.

