

Per Seat Weight Limitation

**100 LBS**





---

# MAINTAINANCE AND WARNINGS



## Before You Start

***Please follow the steps below:***

-  Check the packaging for any damage, deformation, or water stains. If there is significant damage, please contact us promptly.
-  Open the packaging and confirm that the panels, hardware, screws, etc are complete.
-  Please read the installation instructions carefully to understand the installation steps and precautions to ensure proper installation.
-  Clean the installation area in advance and ensure the ground is level and there is enough space to avoid damaging the furniture or making installation difficult.
-  Lay a protective mat on the ground to prevent scratching the floor during installation.

### ***After-Sales Service***

- If you encounter any issues or need technical support during use, please contact our after-sales team. We offer long-term maintenance and warranty services.



## Precautions

- ⚠ This product for indoor use only. Do not expose it to outdoor elements or high-humidity environments.
- ⚠ Keep the product away from high heat or open flames to prevent fire hazards.
- ⚠ Do not allow children to climb on the product to prevent personal injury caused by tipping



## Safety Warnings

- ⚠ If you notice any loose or damaged parts, stop using the product immediately and contact customer service.
- ⚠ Do not attempt to disassemble or replace any components yourself, as this may affect the stability and safety of the product.

- **Daily Maintenance**

Regularly clean the surface of the sofa with a soft cloth to prevent dust accumulation.

Do not use cleaning agents containing acids, alkalis, or corrosive substances, as they may damage the surface. It is recommended to use neutral cleaning agents or specialized furniture cleaners

- Avoid exposing furniture to humid environments for extended periods to prevent swelling or deformation of the boards. Use a dehumidifier or desiccant during humid weather.

- Avoid direct contact of furniture with water. If water is accidentally spilled, wipe it dry immediately.

Avoid placing excessively heavy objects on the furniture: ensure the weight is within a reasonable load-bearing range.



- Avoid using sharp or rough items on the furniture surface to prevent scratches, Handle items gently when moving them

-

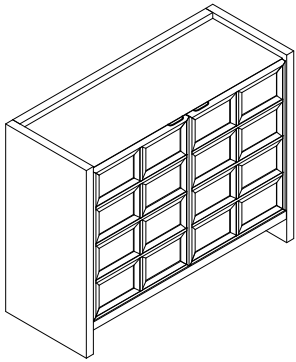
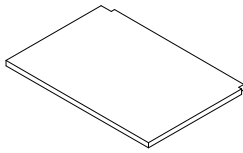
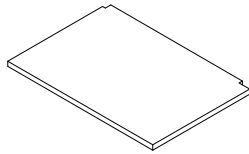
## Parts list

<p><b>A</b></p>  <p>x1</p> <p>Emanuel Storage Cabinet</p>	<p><b>B</b></p>  <p>x1</p> <p>Left Shelf</p>	<p><b>C</b></p>  <p>x1</p> <p>Right Shelf</p>
--	--	--

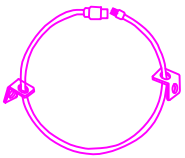
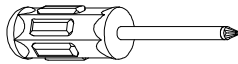
## Hardware List

<p><b>1</b></p>  <p>x2</p> <p>Tipping Restraint (customer assembly required)</p>	<p><b>2</b></p>  <p>x1</p> <p>Screwdriver (not provided)</p>
<p><b>3</b></p>  <p>x9</p> <p>Pin</p>	<p><b>4</b></p>  <p>x9</p> <p>D3.5x15mm</p> <p>Screw</p>



Installation:  
25minutes.



One Person

## Step 1

Find the left shelf(B), right shelf(C) on the cabinet top, and to sure the side which should be faced down.

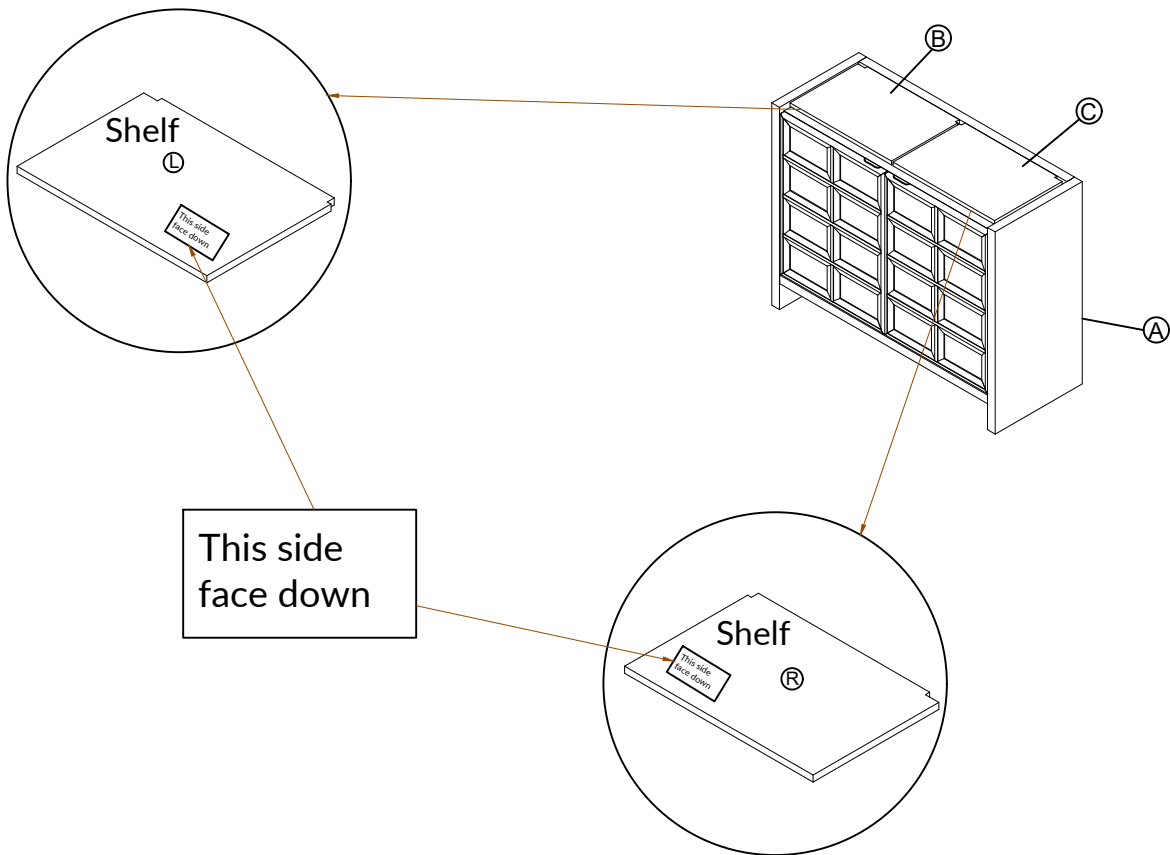

## Step 2

Put the shelves(B,C) in the cabinet as per show.

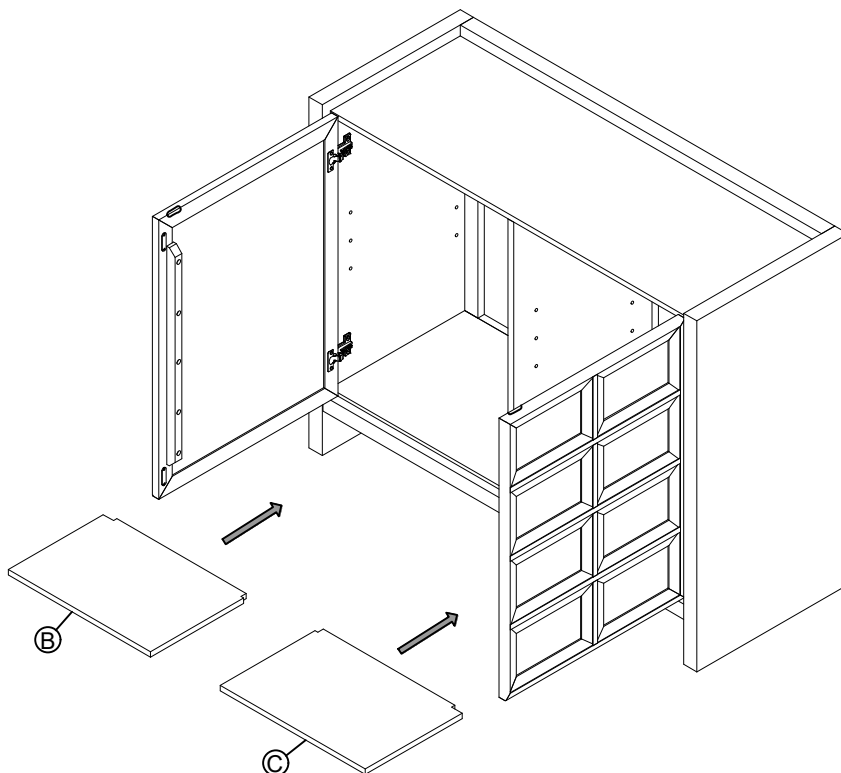

### Step 3

Secure shelves with pin(3), screws(4) by using screwdriver(2).

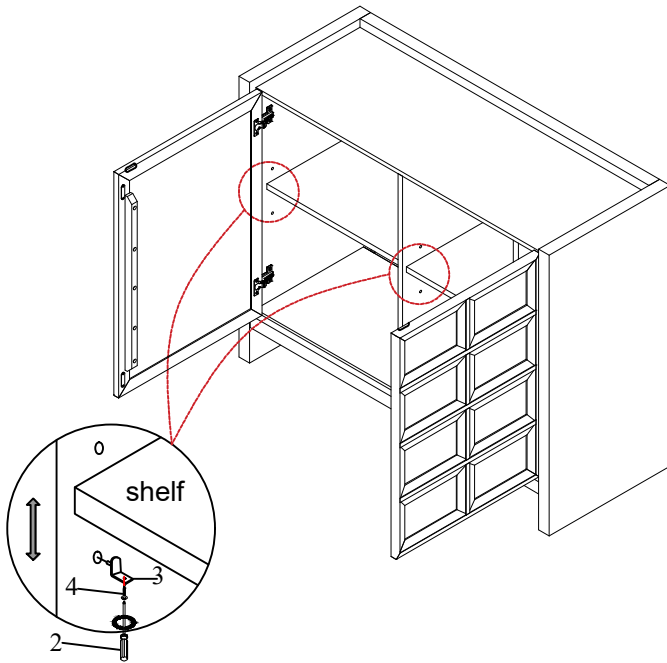

③	x8	④	x8
		D3.5x15mm	

### Step 4

Attach the tipping restraint(1) to the wall.

Remark: anti-tip hardware must be installed by customer.

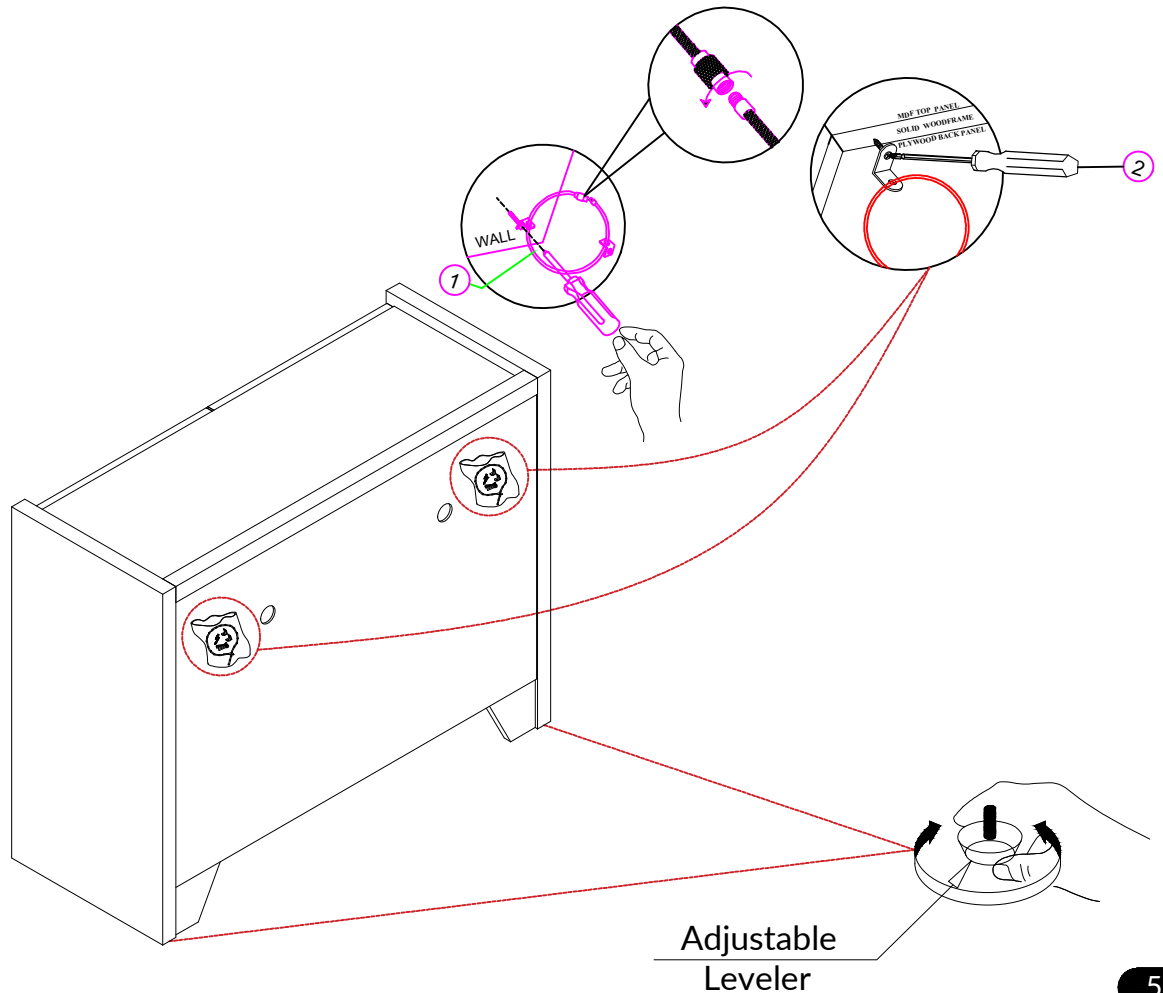

# WARRANTY

- We strive to offer quality products, and we also try our best to satisfy every customer who orders from us with products or services as needed.
- We provide 30 days warranty starting from the time you receive the item.  
Each customer must provide a record of their orders such as the order number, or item receipt for any items that are out of the warranty period you may also still receive.

- Replacement parts by purchasing them from our company if they are available.

- For return, please check the return policy with the retailer or market place you bought from