







## Part List

PIECE	DESCRIPTION	PICTURE	QUANTITY
A	Back		1x
B	Seat		1x
C	Left side		1x
D	Right side		1x

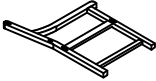
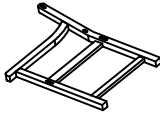
## Hardware List

PIECE	DESCRIPTION	PICTURE	QUANTITY
HW1	T Bolt & nut	 M6x70	6x
HW2	Extra bolt	 M6x45	1x
HW3	Allen Key		1x

## Installation & Assembly

Product Dimension: 59.06" L x 23.62 "D x 34.65"H

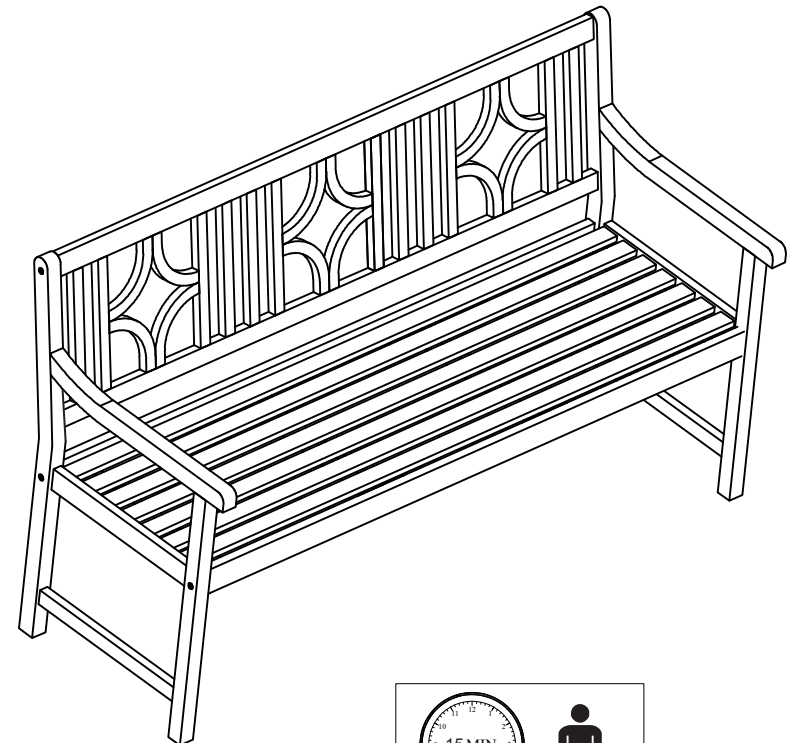

**WEIGHT CAPACITY: 275 LBS PER SEATING**  
**WARNING: DO NOT STAND ON CHAIR**

# PREPARATION

Tool required for assembly (included): Allen Key.

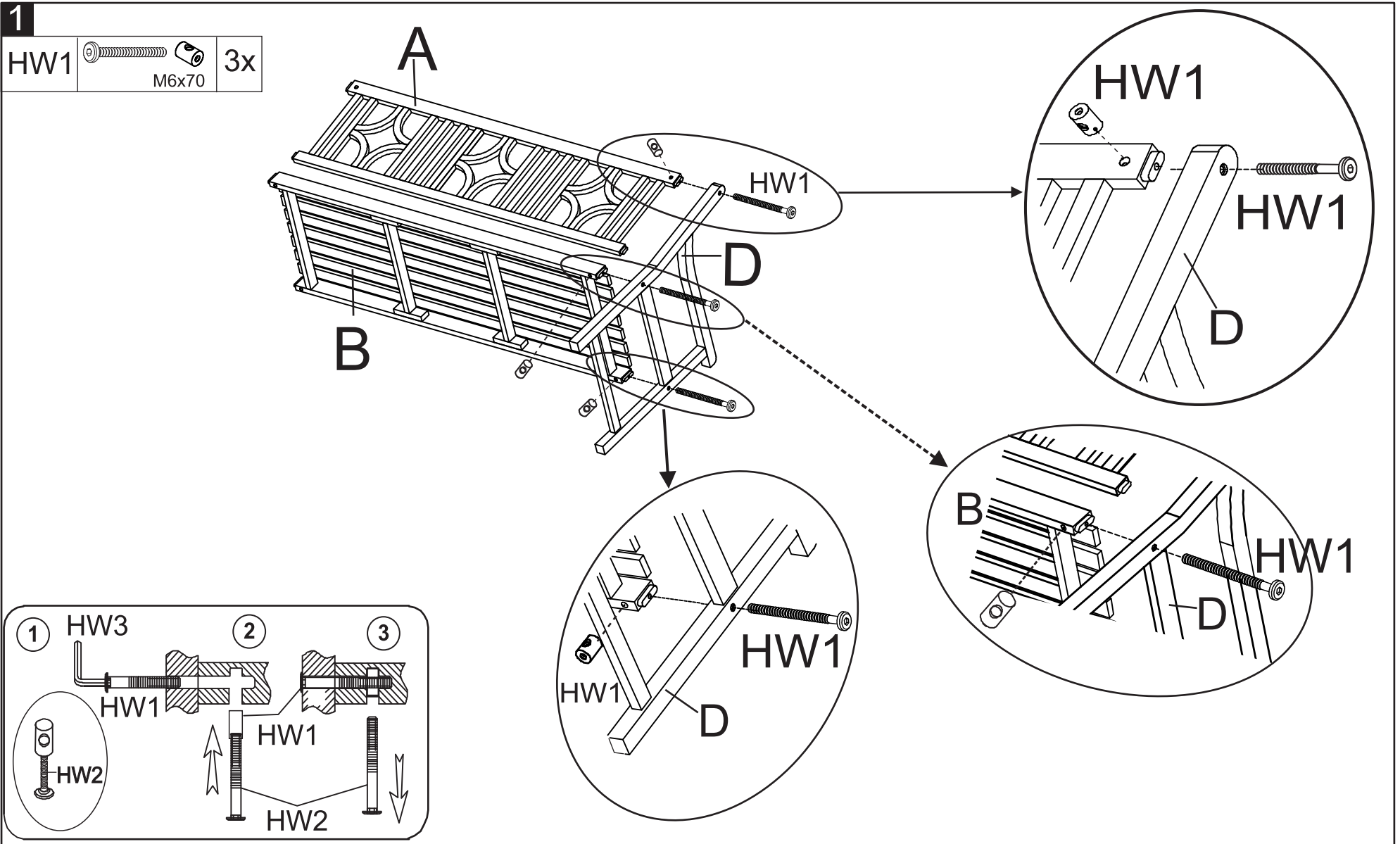

Step 1: Attach the Right side (D) to the Back (A) and the Seat (B) as shown in the picture .Using the T Bolt & nut (HW1) to fix the Back (A) , Seat (B) by the Allen key (HW3) and Extra bolt (HW2).

