

Assembly Instructions

Caution : You must read this before you proceed

Reclining Chair

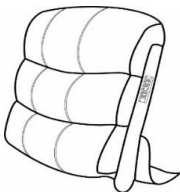
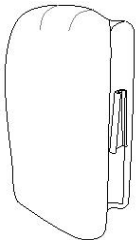

Parts List

Label	Picture	Description	QTY
A		Chair Backrest	1
B		Left Wing (Labelled B)	1

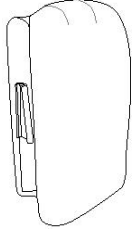
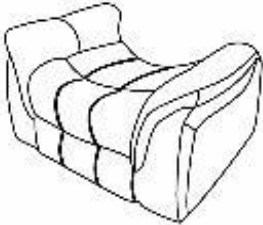
C		Right Wing (Labelled C)	1
D		Chair Base with Footrest	1

Assembly Preparation

Before Beginning Assembly:

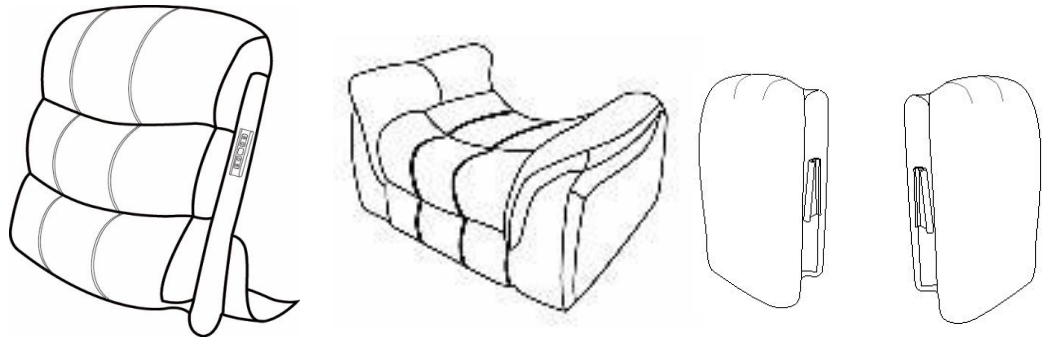

- Read instructions, cover to cover-



- Have 2 adults on hand for assembly-



- Do not assemble on flooring or carpet-



- Assemble on a clean non-marring surface (packing foam)-



- Save all packaging until finished-

Assembly Steps

Parts Introduction

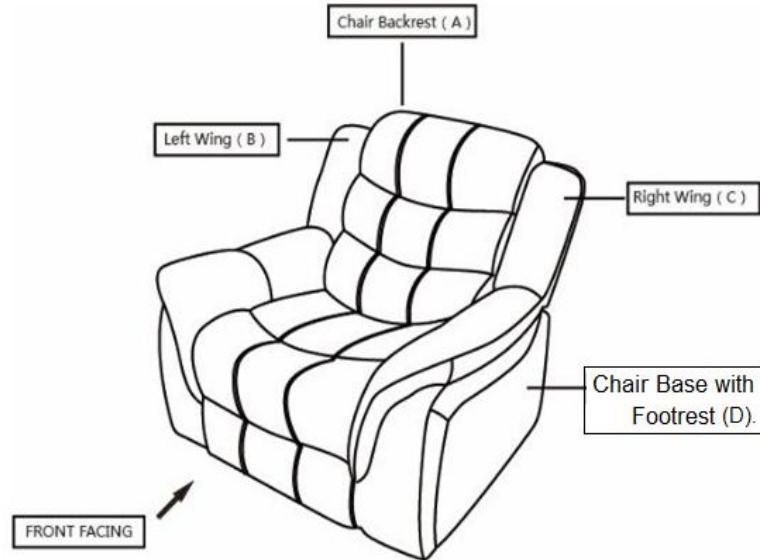

This Reclining Chair has multiple parts and may require up to some 30 minutes to assemble. To give you an overview of the Reclining Chair parts, the above picture is to help you put the various parts into perspective. Please read through the instructions below to familiarise yourself with the parts and steps before assembly.

Step 1

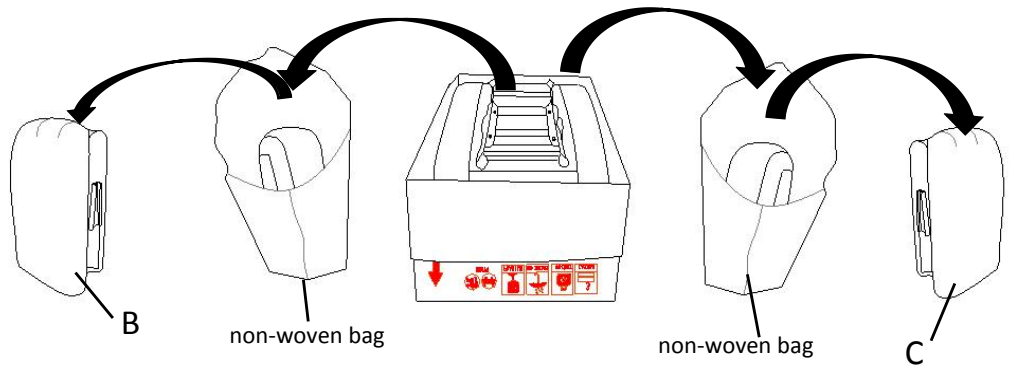

Take out 2 non-woven bags with two Wings inside from the bottom of the armrest. Then take out the Wing from non-woven bag.

Step 2

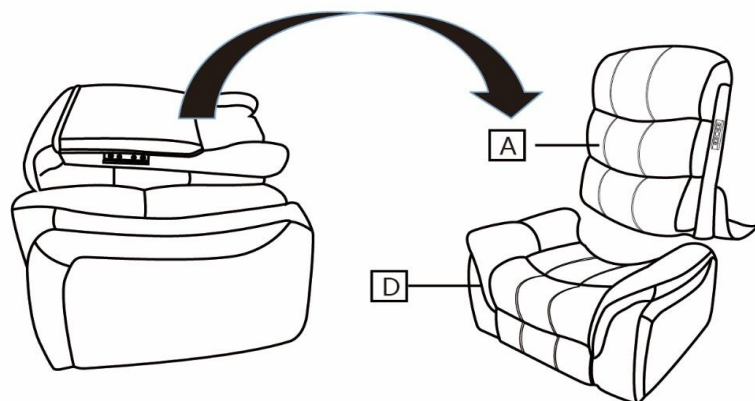

Take out the Chair Backrest(A) from the Chair Base with Footrest (D).

Step 3

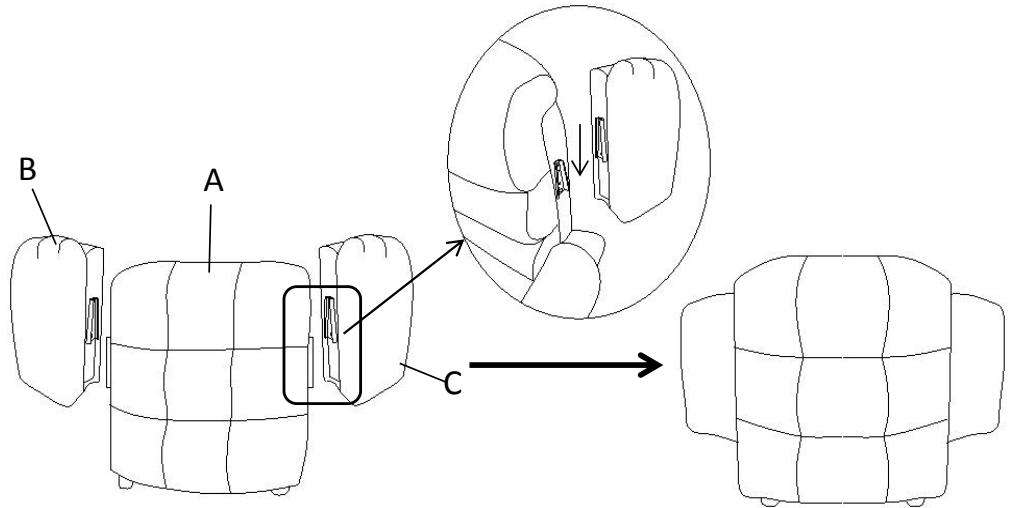

Position the Chair Backrest(A) on it's right side.

Align the mounting brackets of the Left Wing(B) with those on the left side of Chair Backrest(A). Then slide Left Wing(B) forward by hand to make sure it locks into the position as shown in the picture.

Repeat the process from **Step 3** to attach Right Wing(C) to the right side of Chair Backrest(A).

Step 4

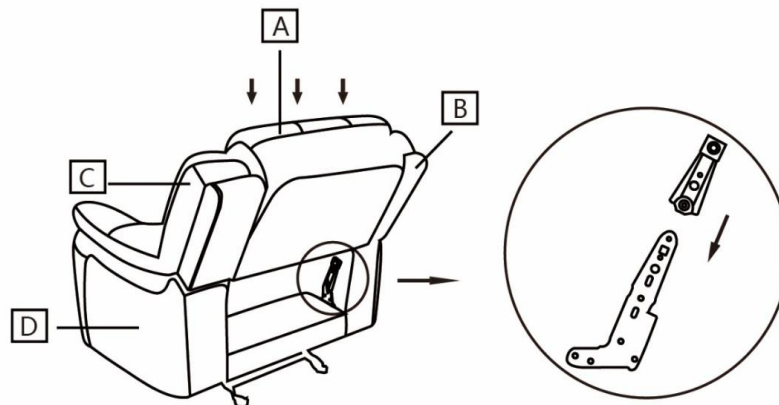

With assistance from your adult partner, hold up the fully assembled Chair Backrest(A)with Wings, and stand behind the Chair

Insert the small metal arms on the sides of the Chair Backrest(A) into the prefabricated slide lock gadget on the Chair Base with Footrest (D) as shown above.

Firmly but gently, push the Chair Backrest(A) downwards until the it is fully slotted and locked into position.

Step 5



Smooth down the fabric flap on the Chair Backrest(A).

Run your hands down both sides of the flap, from top to bottom, allowing the velcro tape to adhere to the flap under the seat of the chair.

Step 6

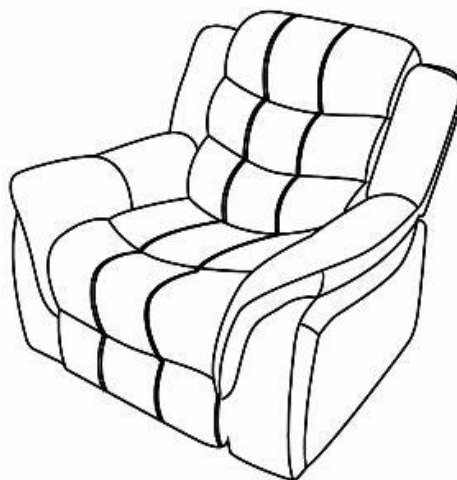

Your Sofa is ready for use.

This Sofa can only be used on a flat, level surface.

Warning



Correct Way to Use



Incorrect Way to Use



Incorrect Way to Use



Incorrect Way to Use

Do not allow children to play on the chair.
Always leave the chair in an upright and closed position after use!
Keep hands and feet clear of the footrest mechanism and ANY gaps.
Only the occupant should operate the chair.

User Instructions.

Recliner Chair

Please read the Instruction Manual below carefully before use.

This is a Recliner Chair. At anytime in a reclined seat position or in the upright position. You may enjoy the rocking motion by using your body weight in a back-front rocking motion, and also the swivel motion.

Supervise children, when in use of this Recliner.

To get into a reclined posture - To Recline backrest

Sit into the seat.
Open the trigger on the outside of right armrest.
Use your body weight and push backwards into the seat into a fully reclined position.







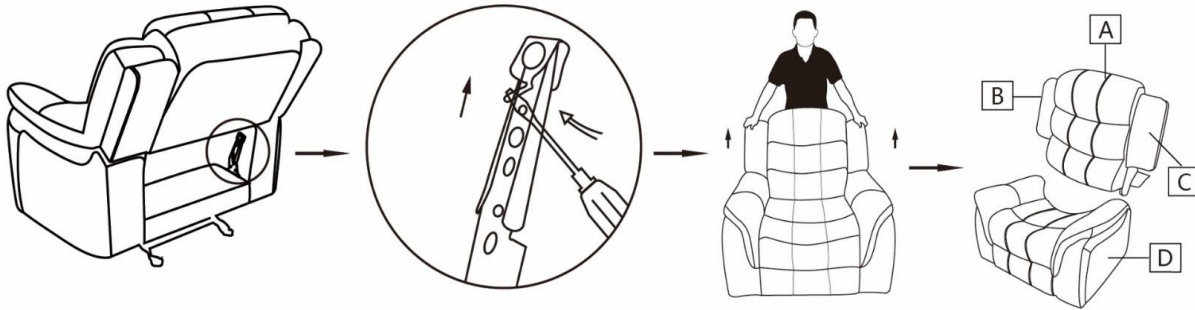
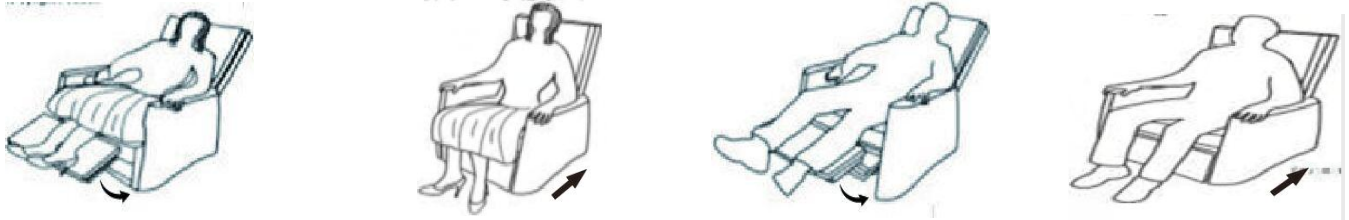















To get out of chair - move Seatback into Upright Position

Tilt your body weight slightly forward and upwards.
The seat back will come up to an upright position.
Use your feet to push the footrest back. You can stand up when the footrest and the mechanism clicked.
Where necessary, use either your arms help lift- push yourself out of the seat.



Disassembly Note: Open the flap on the Chair Backrest(A), use a screwdriver (Don't use fingers) pressing outward on the metal ear on the preattached Metal Bracket on one side of the Chair Base(D), with assistance of your adult partner to keep the Chair Base(D) in place, pull out the Chair Backrest(A) upward at the same time, repeat the same step for another side. Then the Chair Backrest(A) can be taken out.

Care & Maintenance

-   ● Do not put hot items directly on furniture surface.
 -   ● Do not clean furniture with harsh cleansers or polish.
 -   ● Do not place furniture under direct sunlight.
 -   ● Do not place furniture near heating or cooling vents.
 -   ● Do not write on furniture without a padded barrier to protect the surface.
 -   ● Do not place furniture outside. For indoor use only.
 -   ● Not for commercial use. For residential use only.
 -   ● Stains may be removed with mild soap solution and damp cloth.
 -   ● Children should not climb or jump on the furniture.
-
-   ● Dust and pick-up spills using a clean, non-colored, lint-free cloth.

Questions & Answers about Proposition 65

• What is Proposition 65?

Proposition 65 requires businesses to provide warnings to Californians about significant exposures to chemicals that cause cancer, birth defects or other reproductive harm. These chemicals can be in the products that Californians purchase, in their homes or workplaces, or that are released into the environment. By requiring that this information be provided, Proposition 65 enables Californians to make informed decisions about their exposures to these chemicals.

Proposition 65 also prohibits California businesses from knowingly discharging significant amounts of listed chemicals into sources of drinking water.

Proposition 65 requires California to publish a list of chemicals known to cause cancer, birth defects or other reproductive harm. This list, which must be updated at least once a year, has grown to include approximately 900 chemicals since it was first published in 1987.

• What types of chemicals are on the Proposition 65 list?

The list contains a wide range of naturally occurring and synthetic chemicals that include additives or ingredients in pesticides, common household products, food, drugs, dyes, or solvents. Listed chemicals may also be used in manufacturing and construction, or they may be byproducts of chemical processes, such as motor vehicle

• What does a warning mean?

If a warning is placed on a product label or posted or distributed at a workplace, a business, or in rental housing, the business issuing the warning is aware or believes that it is exposing individuals to one or more listed chemicals.

By law, a warning must be given for listed chemicals unless the exposure is low enough to pose no significant risk of cancer or is significantly below levels observed to cause birth defects or other reproductive harm.