

ASSEMBLY INSTRUCTION

SELF ASSEMBLY



1 Person build
Estimated build time
15 min



CAUTION!

It is the responsibility of the persons assembling the furniture to properly install all components and hardware as specified in these instructions. Please follow strictly the order of assembly shown in these instructions.

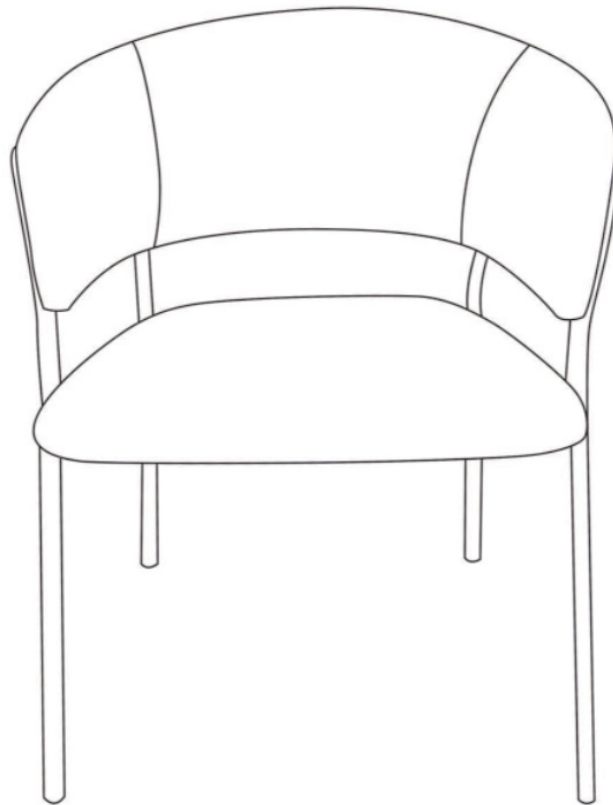

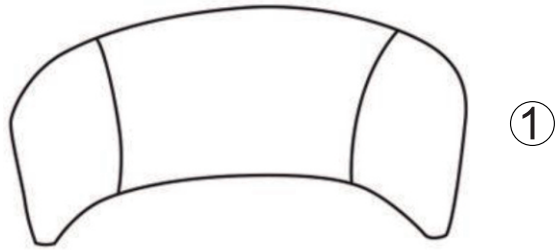

1× ①
1× ②
1× ③

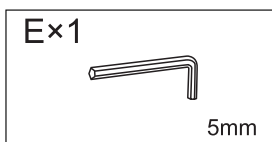
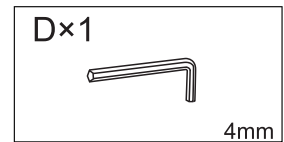
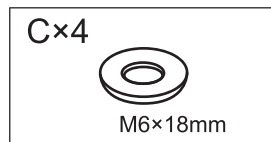
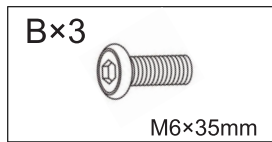
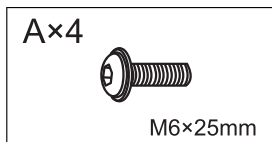
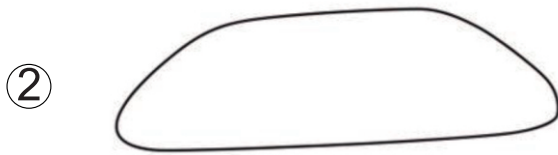

1

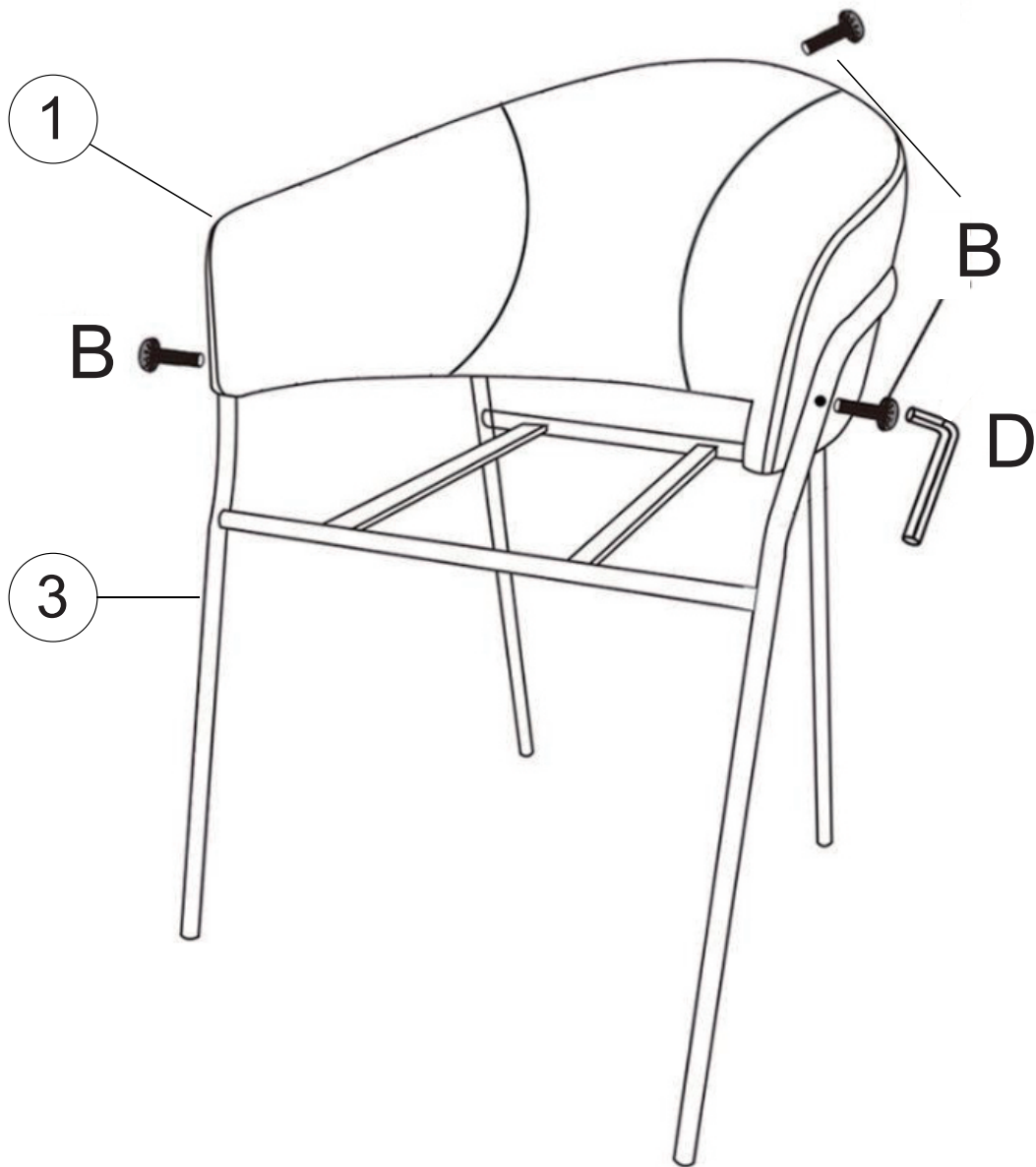
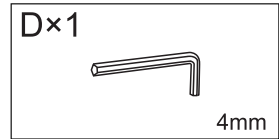
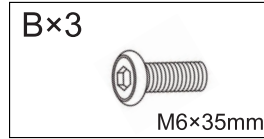
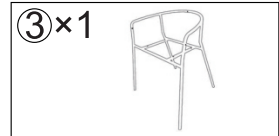
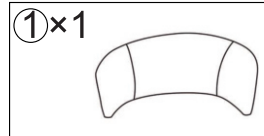

Please screw the nails on both sides first,
and then screw the nails in the middle of the backrest.

2

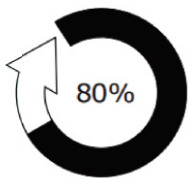
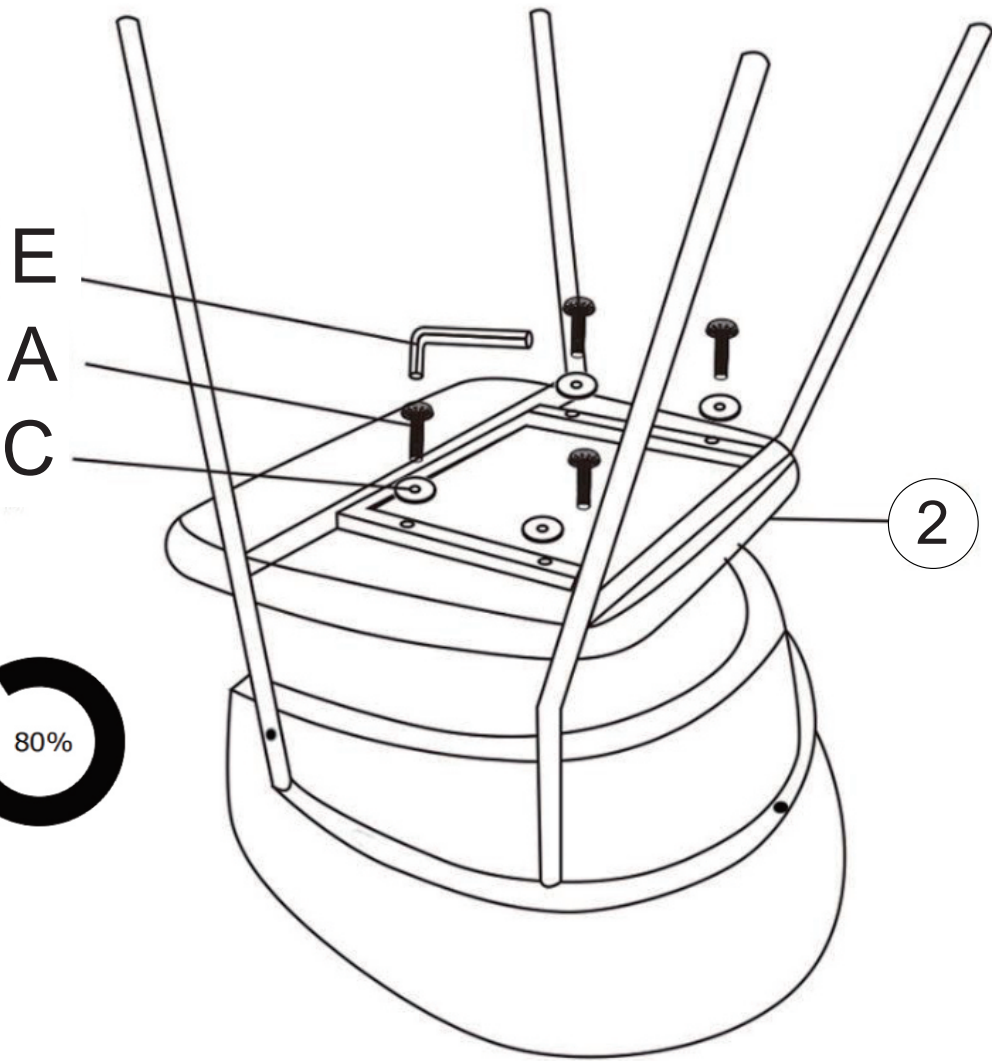
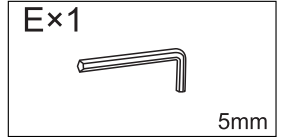
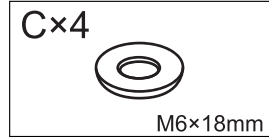
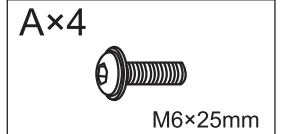
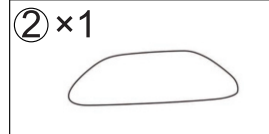

Before fully assembling all parts,
make sure to tighten all screws
only to 80% of their final tightness.
Do not over-tighten at this stage.

3

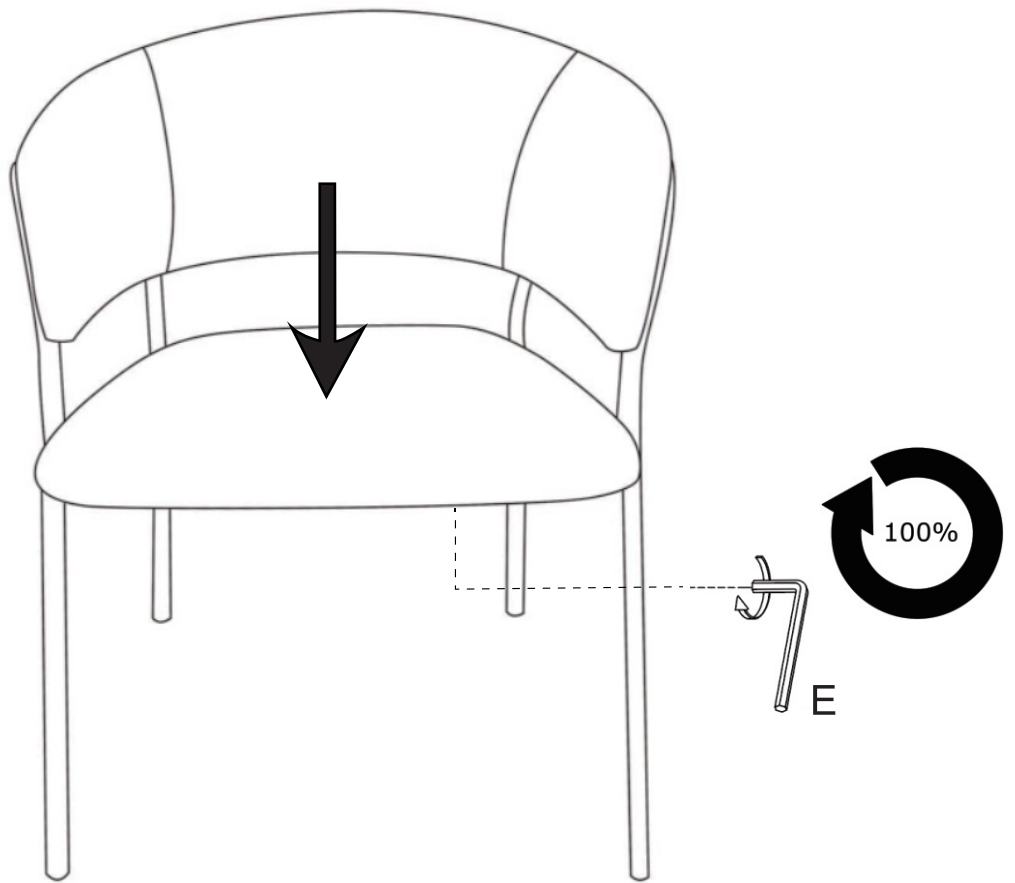

Turn the chair over and position it correctly. Adjust all legs so they rest evenly on the floor, then slowly tighten the screws. During this process, gradually tighten the screws while adjusting the legs for balance until all the screws are securely tightened.