

# COFFEE TABLE

Assembly Instructions - Please keep for future reference

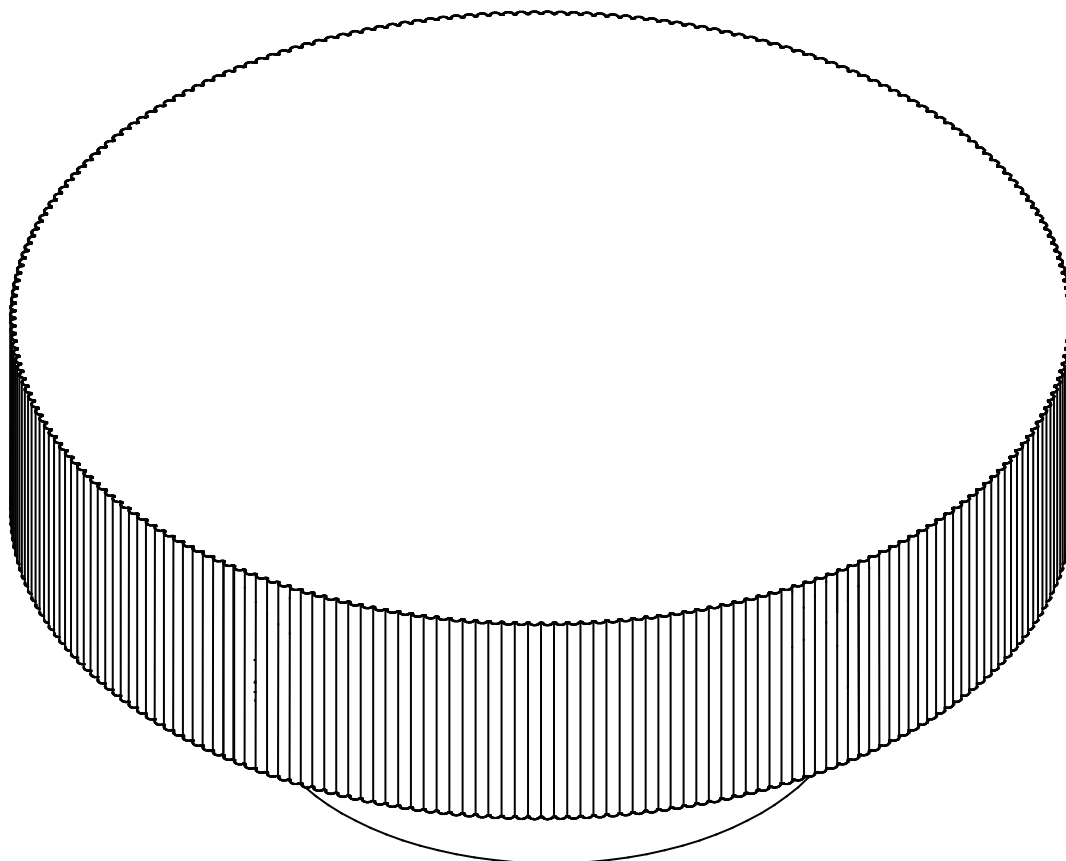

## Dimensions

Width- 31.69inch

Depth-31.69inch

Height-13.77inch

Important – Please read these instructions fully before starting assembly



# Safety and Care Advice

**Important – Please read these instructions fully before starting assembly**

- Check you have all the components and tools listed on the following pages.
- Remove all fittings from the plastic bags and separate them into their groups.
- Keep children and animals away from the work area, small parts could choke if swallowed.
- Make sure you have enough space to layout the parts before starting.

- During assembly do not stand or put weight on the product, this could cause damage.
- Assemble the item as close to its final position (in the same room) as possible.
- Assemble on a soft level surface to avoid damaging the unit or your floor.
- Parts of the assembly will be easier with 2 people.



power drill is set on a low torque setting.

- To reduce the likelihood of damaging your product please ensure that your

## Care and maintenance

- Only clean using a damp cloth and mild detergent, do not use bleach or abrasive cleaners.
- From time to time check that there are no loose screws on this unit.
- This product should not be discarded with household waste. Take to your local authority waste disposal centre.

## Handy Hints

- Assemble all parts and bolts loosely during assembly, only once the product is complete should you fully tighten the bolts
- Regularly check and ensure That all bolts and fittings are tightend properly.

**WARNING**  
**In order to help prevent overturning –**  
**please follow these instructions**

To help prevent product toppling over please follow the below steps:-

- Use the anti tip stap or wall fixing method provided (if applicable)
- Do not allow children to climb or hang on the furniture
- Do not open more than one drawer at a time
- Do not place heavy items in the top drawers
- Do not place heavy items on top of the furniture, unless the furniture has been designed for this purpose

# Components - Fittings

Please check you have all the panels listed below

Note: The quantities below are the correct amount to complete the assembly. In some cases more fittings may be supplied than are required

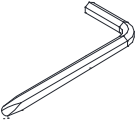
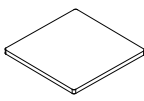
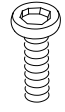
<p>(A)</p>  <p>Allen key x 1</p>	<p>(B)</p>  <p>Foot pad x 4</p>	<p>(C)</p>  <p>6*12mm Screw x 4+2</p>
---	--	--

**Tools required** Not Included

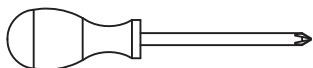

Phillips screwdriver  
(medium & large)

# Using Camlocks

## Step 1

Connect the male camlock as directed in the assembly instructions using a screwdriver.

1

DO NOT OVER TIGHTEN.  
NE PAS SERRER EXCESSIVEMENT.



## Step 2

Push the male camlock into the entry hole.

2



## Step 3

Insert the female camlock as shown in the instruction.

Note: ensure that the arrow on the top of the camlock points towards the entry hole for the male camlock.

3

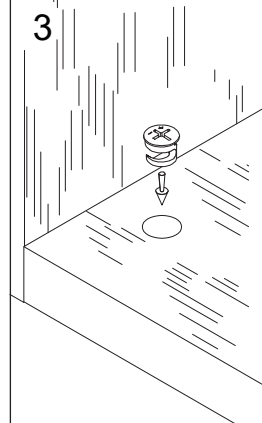

## Step 4

Turn the female camlock clockwise with a screwdriver.

You should feel a click when the camlock is locked in place.

The joint is now secure.

4

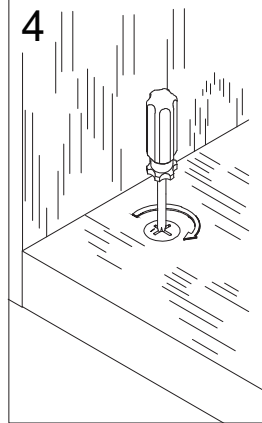

# Assembly Instructions

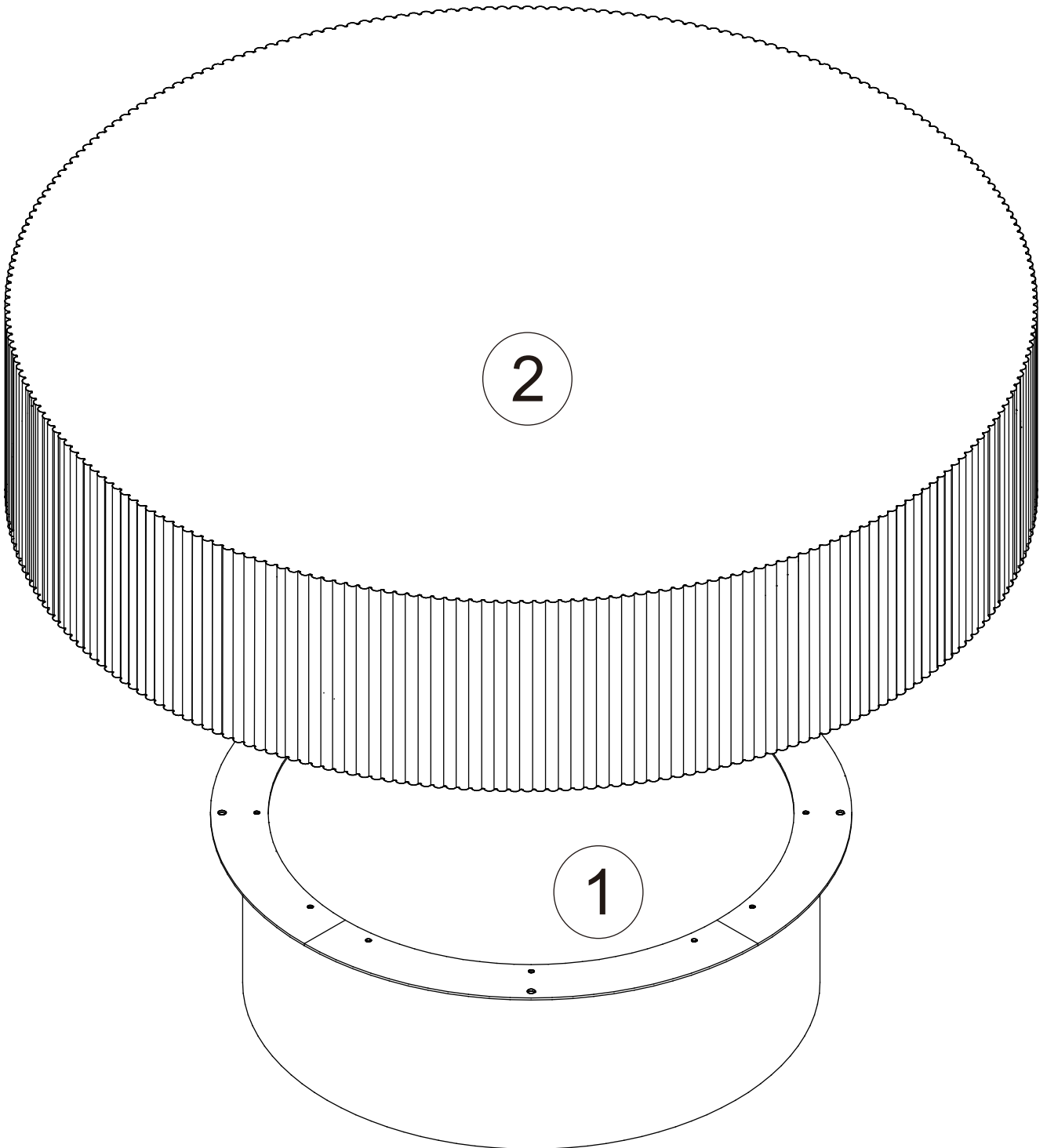

# PART LIST

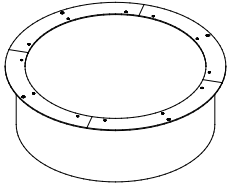

①

x1  
keep one's feet on  
the ground  
∅450x165mm

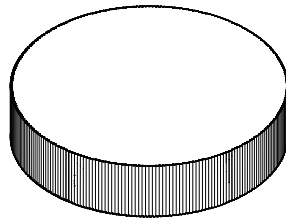

②

x1  
round tabletop  
∅805x180mm

Part#3 is shipped inside with Part#1. Please separate them carefully before installation.

# Assembly Instructions

## Step 1

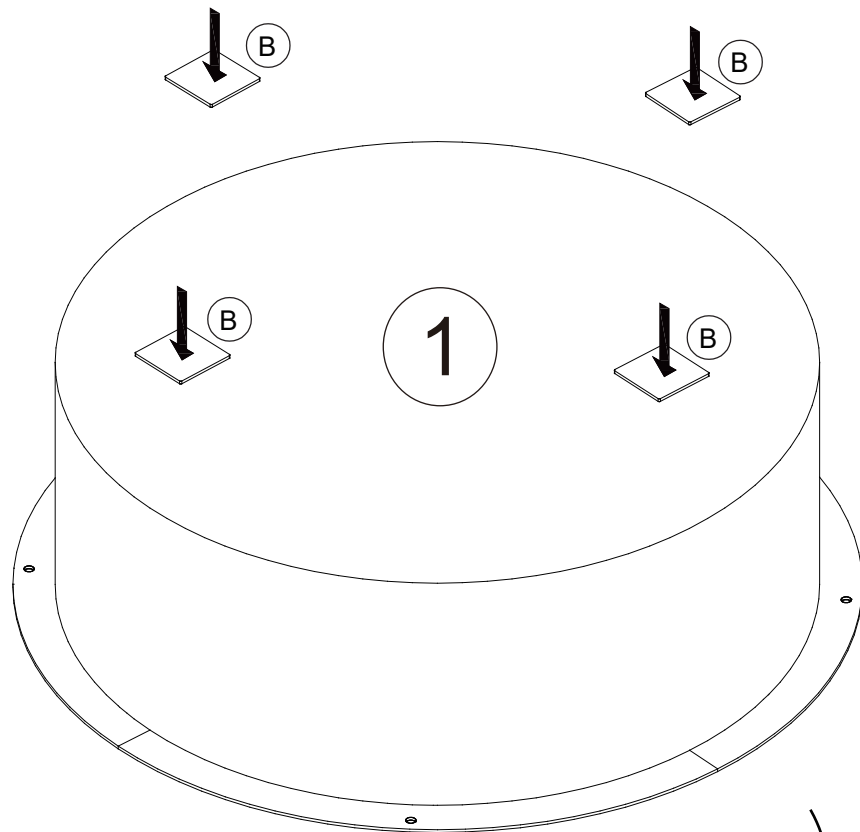

(B)

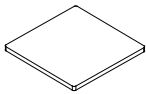

Foot pad x 4

## Step 2

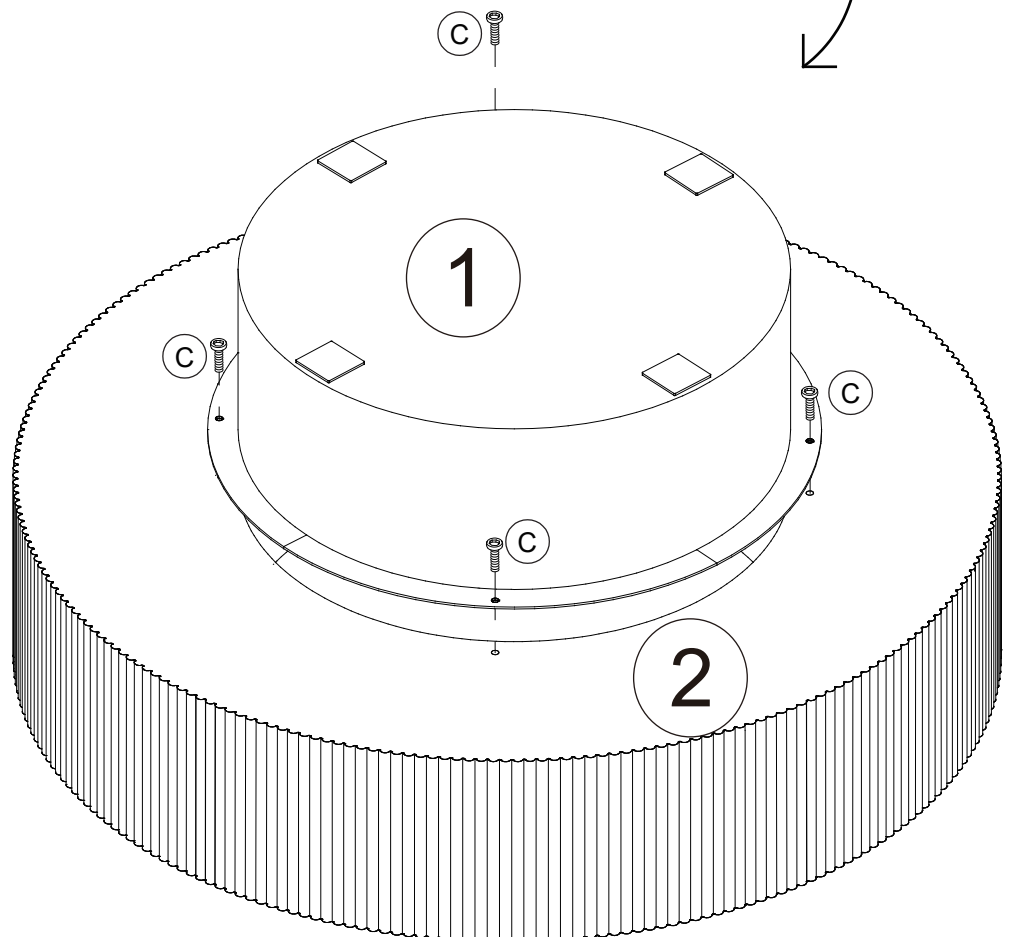

180°

(C)

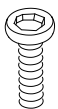

6\*12mm Screw x 4

# Assembly Instructions

Finish

Please flip  
carefully.

