

Installation drawing

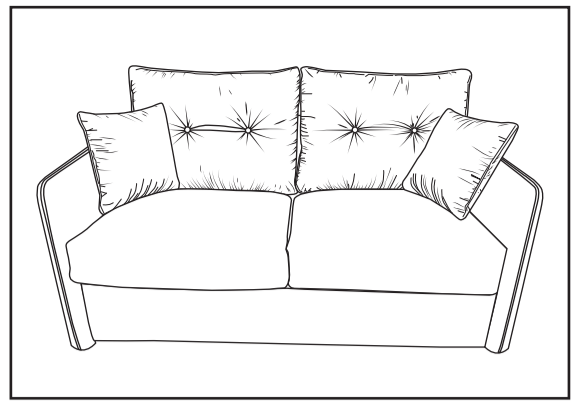

Fittings

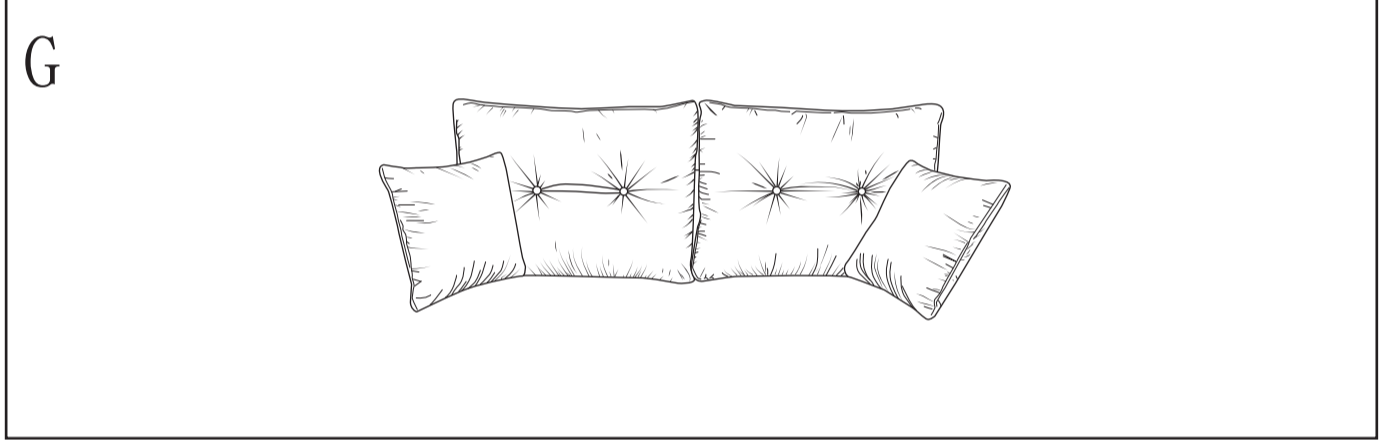
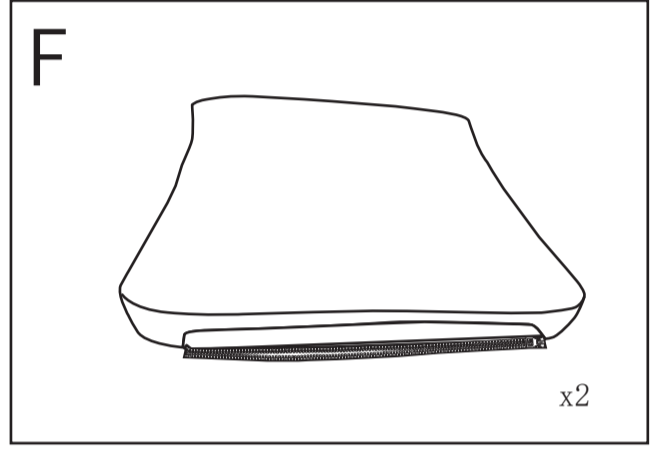
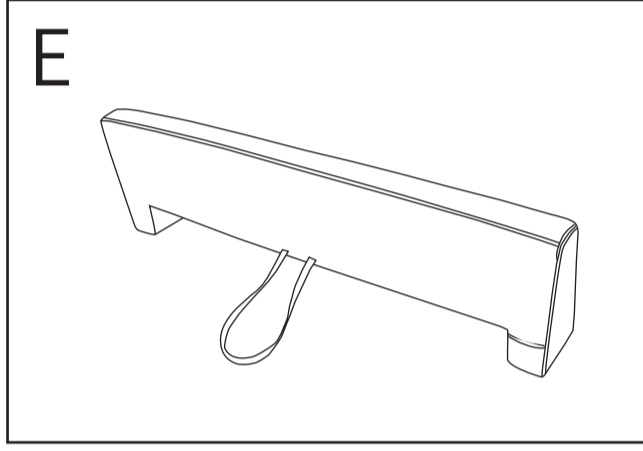
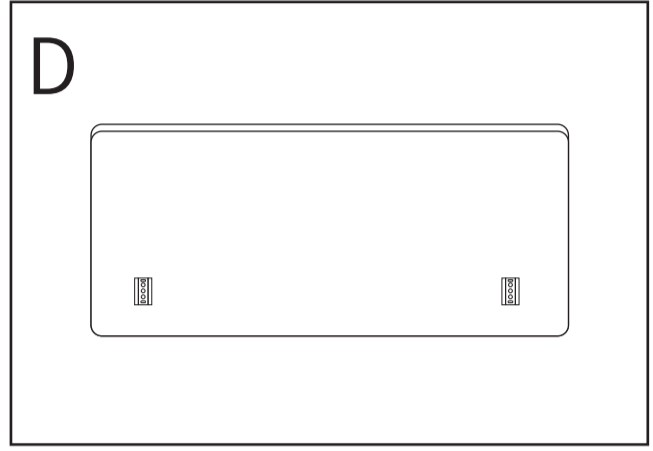
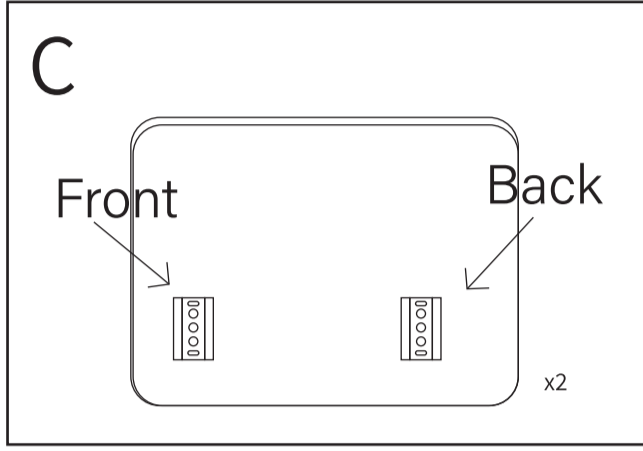
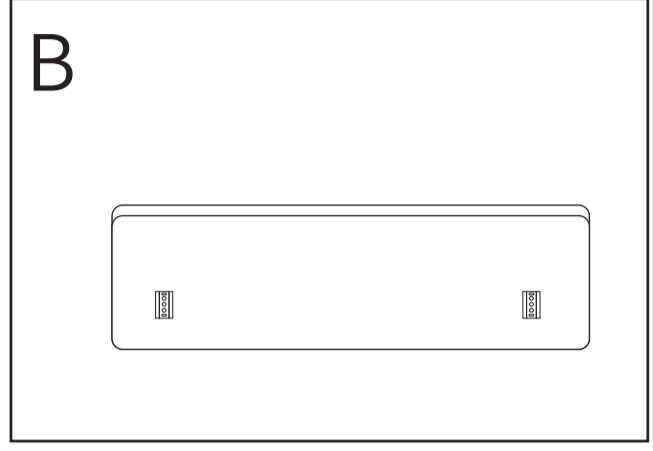
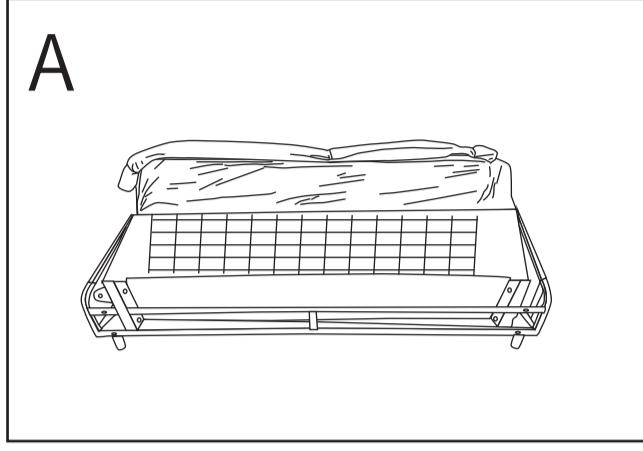
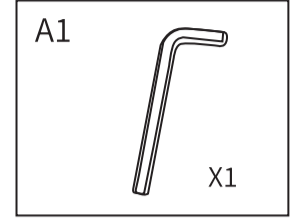

Additional Information: To tighten the screws in Step E, use Accessory A1.
Attach Accessory F to the lower rail using the zipper. The position of the rail has been marked.

Setup Guide

