

---

## NOTE:

This brochure contains IMPORTANT safety info. Please read and keep for future reference.

---

# MAINTAINANCE AND WARNING

- 1.We suggest you spend a short time reading through this leaflet and then follow the simple step-by-step instructions.
- 2.Carefully check that you have all the parts before beginning assembly.
- 3.Keep fittings out of children' s reach and keep children well away from construction area
- 4.We suggest you retain these instructions for future reference.
- 5.Keep furniture away from heat sources.
- 6.Do not clean furniture with harsh cleaner or polishes.
- 7.Do not usedetergents,solvents,abrasives,spray packs or leather cleaner.
- 8.Use non-color mild soap with warm water to clean spills(Mix 1:10 soap to water).
- 9.Do not place furniture under direct sunlight,material will possibly fade over time.
- 10.Do not use on site dry cleaning machine.  
Children should not climb or jump on the furniture.
- 11.Do not write on furniture that is not protected by a padded barrier.
- 12.Not for commercial use,only for residential use.





Weight Limitation  
**300 LBS**

# PARTS LIST

## BOX A

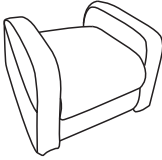
|   |    |
|---|----|
| A   | x1 |
|  |    |
| Backrest  |    |

|   |    |
|---|----|
| B   | x1 |
|  |    |
| Seat cushion  |    |

|   |    |
|---|----|
| C   | x1 |
|  |    |
| Remote control  |    |

|   |    |
|---|----|
| D   | x1 |
|  |    |
| Charger   |    |

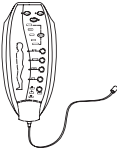
|   |    |
|---|----|
| E   | x1 |
|  |    |
| Remote control  |    |

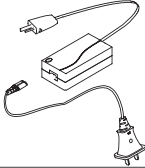
|   |    |
|---|----|
| F   | x1 |
|  |    |
| Power source  |    |

|   |    |
|---|----|
| G   | x1 |
|  |    |
| Right ear   |    |

|   |    |
|---|----|
| H   | x1 |
|  |    |
| Left ear  |    |

|  |    |
|--|----|
| I  | x1 |
|  |    |
| Plate  |    |

|   |
|---|
| 1PERSON   |
|  |

# ASSEMBLY INSTRUCTIONS

## STEP-1

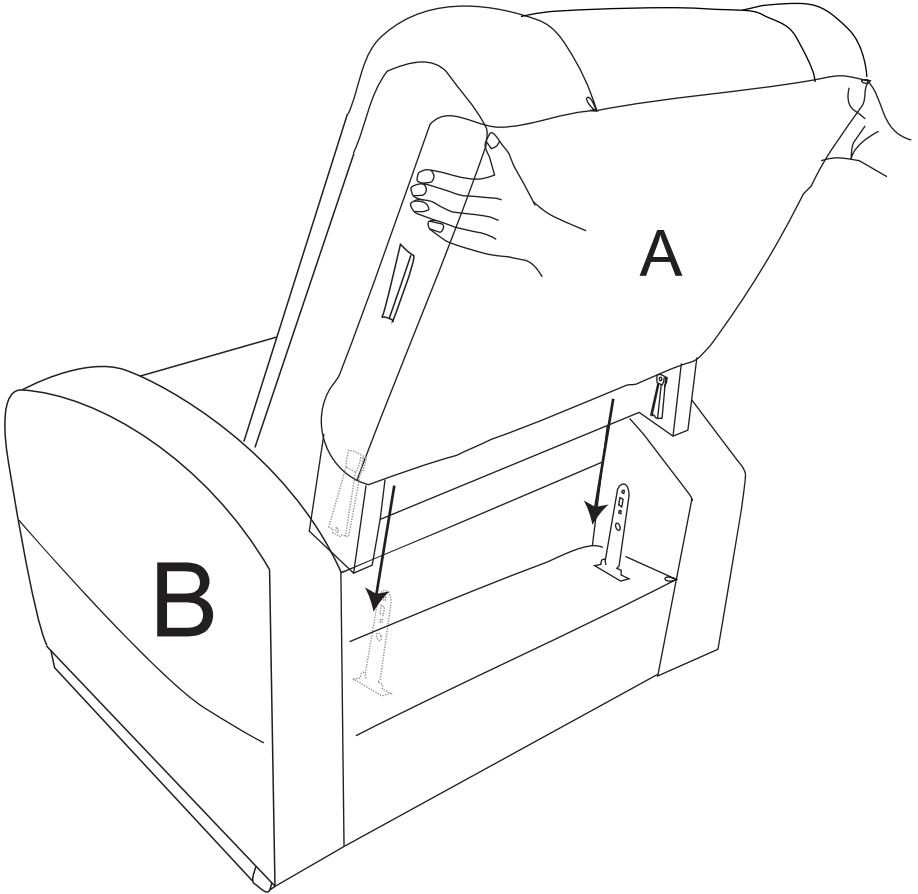

# ASSEMBLY INSTRUCTIONS

## STEP-2

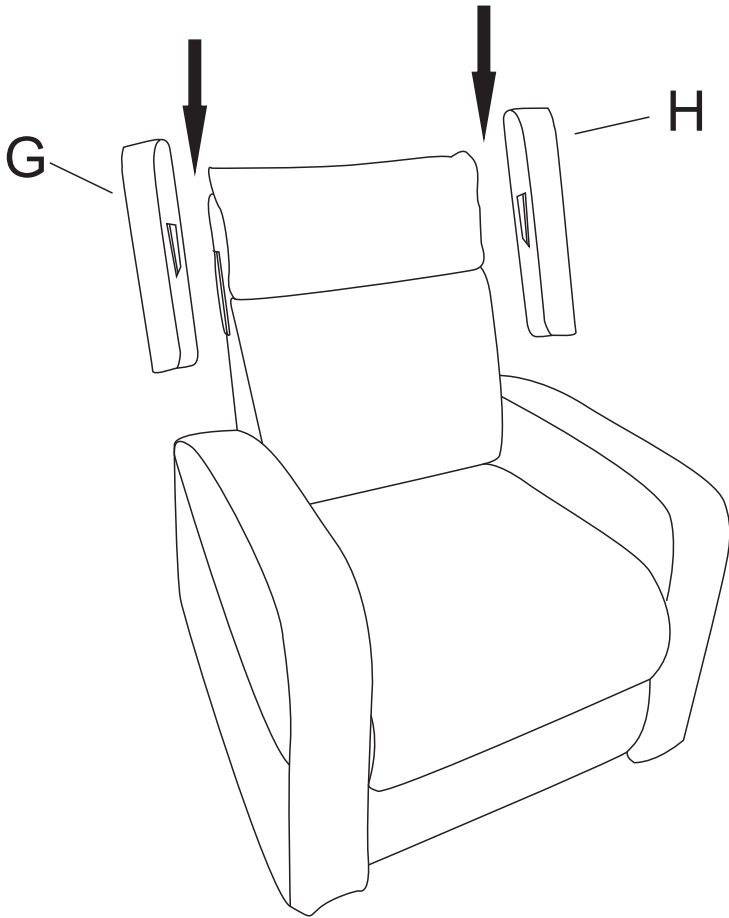

# ASSEMBLY INSTRUCTIONS

## STEP-3

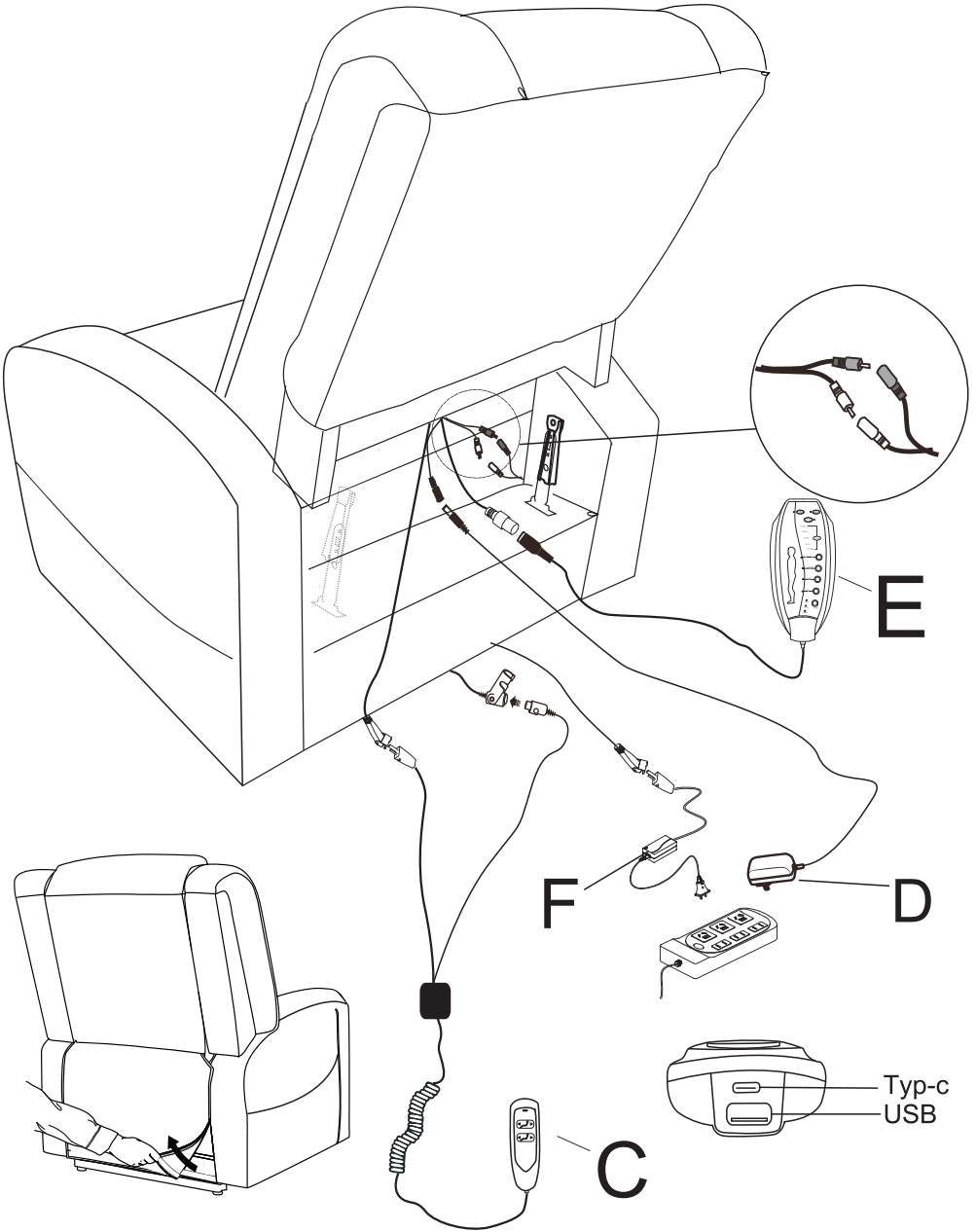

# ASSEMBLY INSTRUCTIONS

## STEP-4

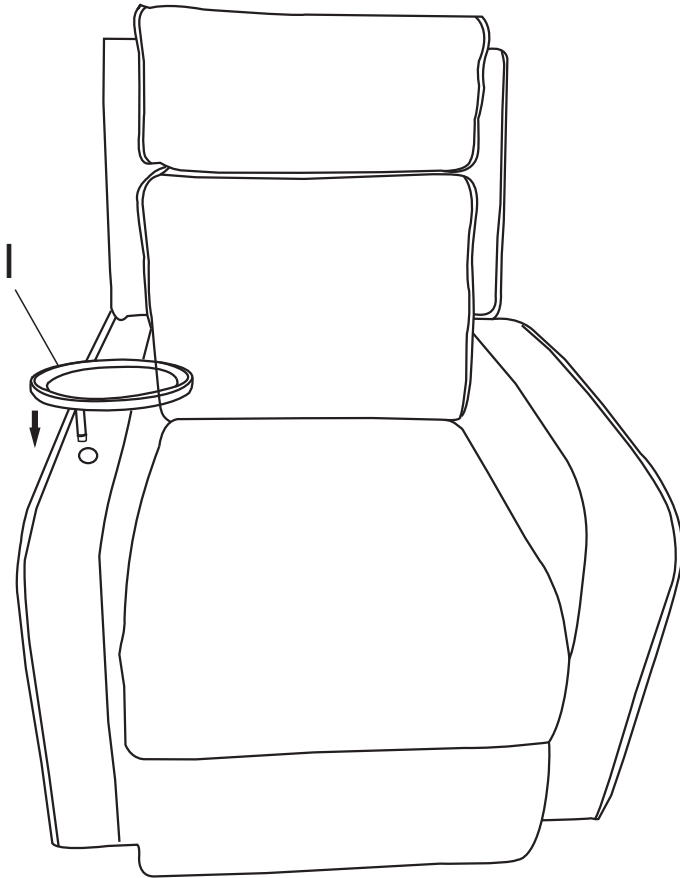

# ASSEMBLY INSTRUCTIONS

## STEP-5

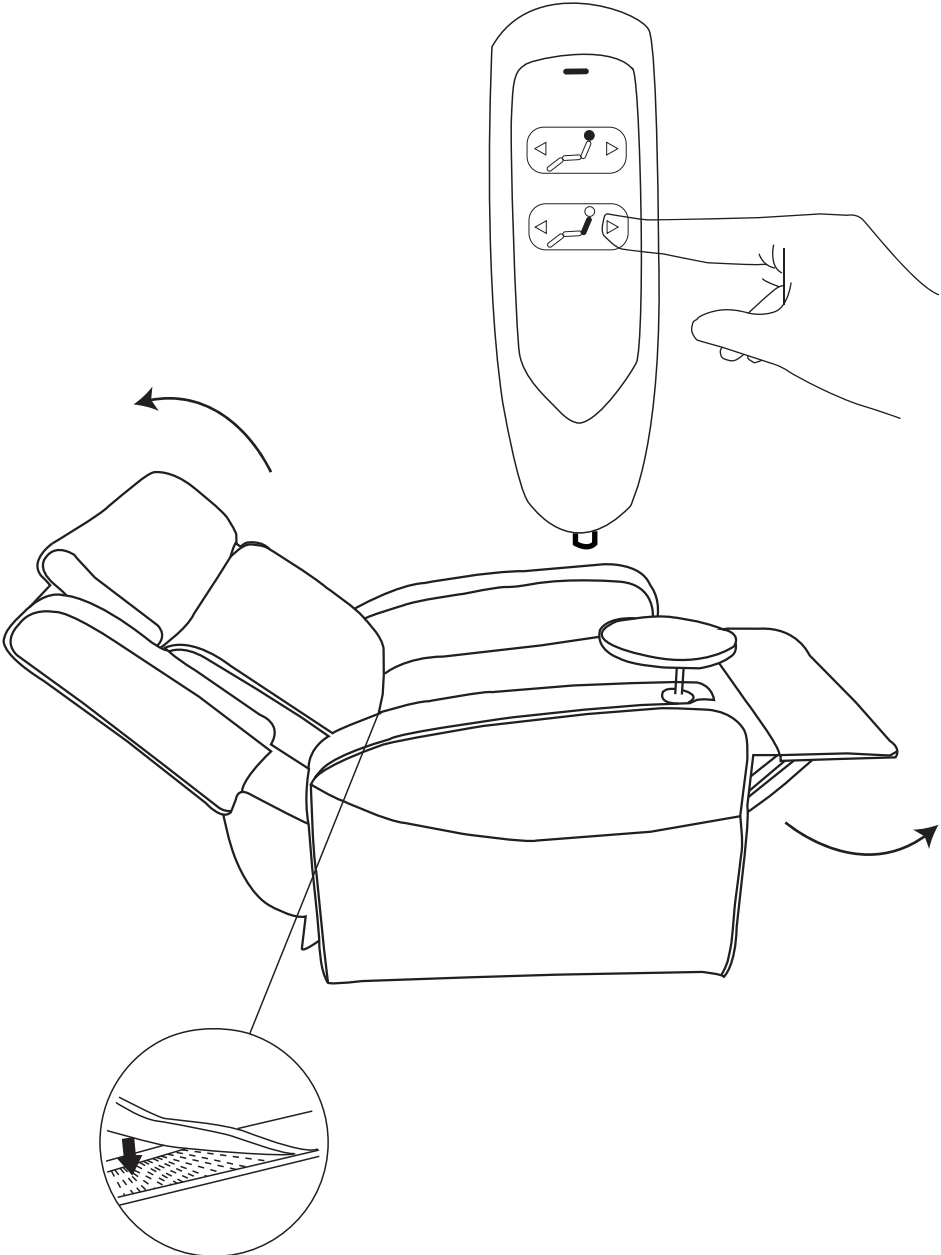

# ASSEMBLY INSTRUCTIONS

## STEP-6

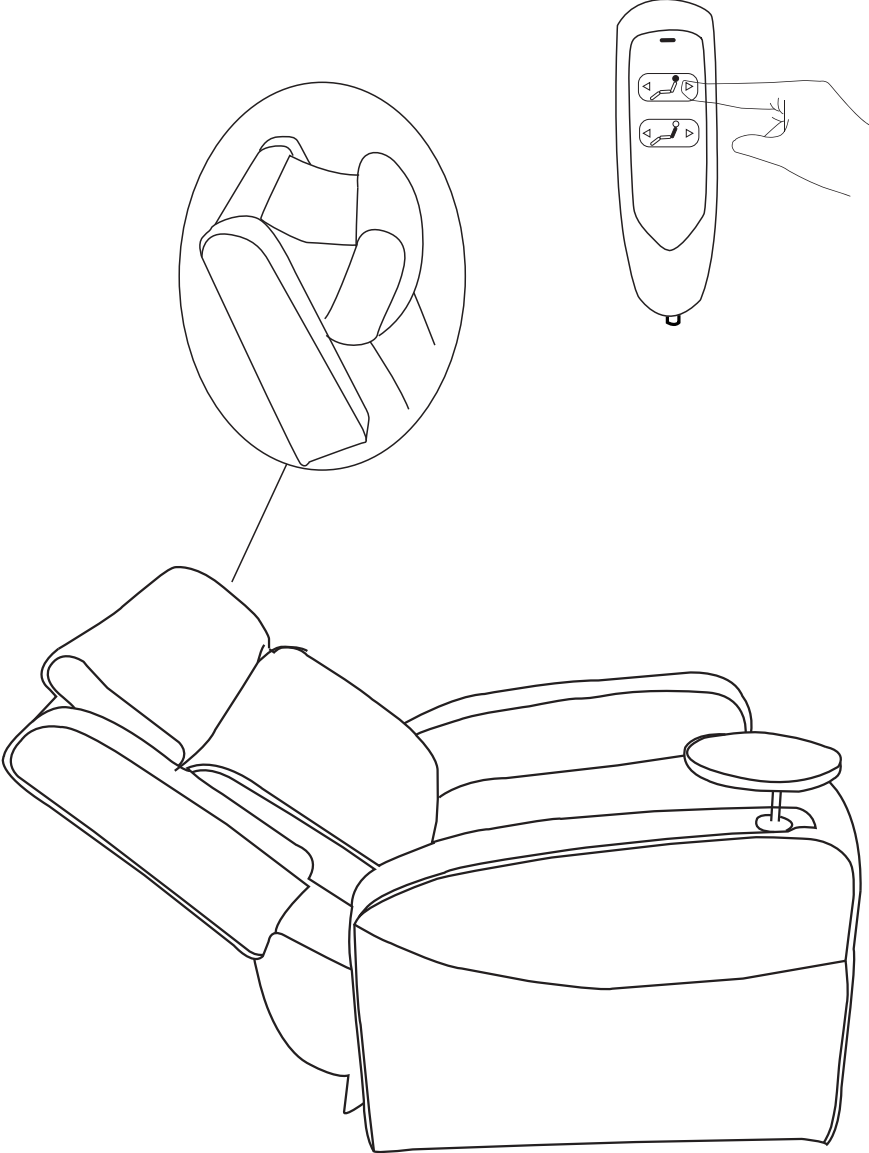

# ASSEMBLY INSTRUCTIONS

## STEP-7



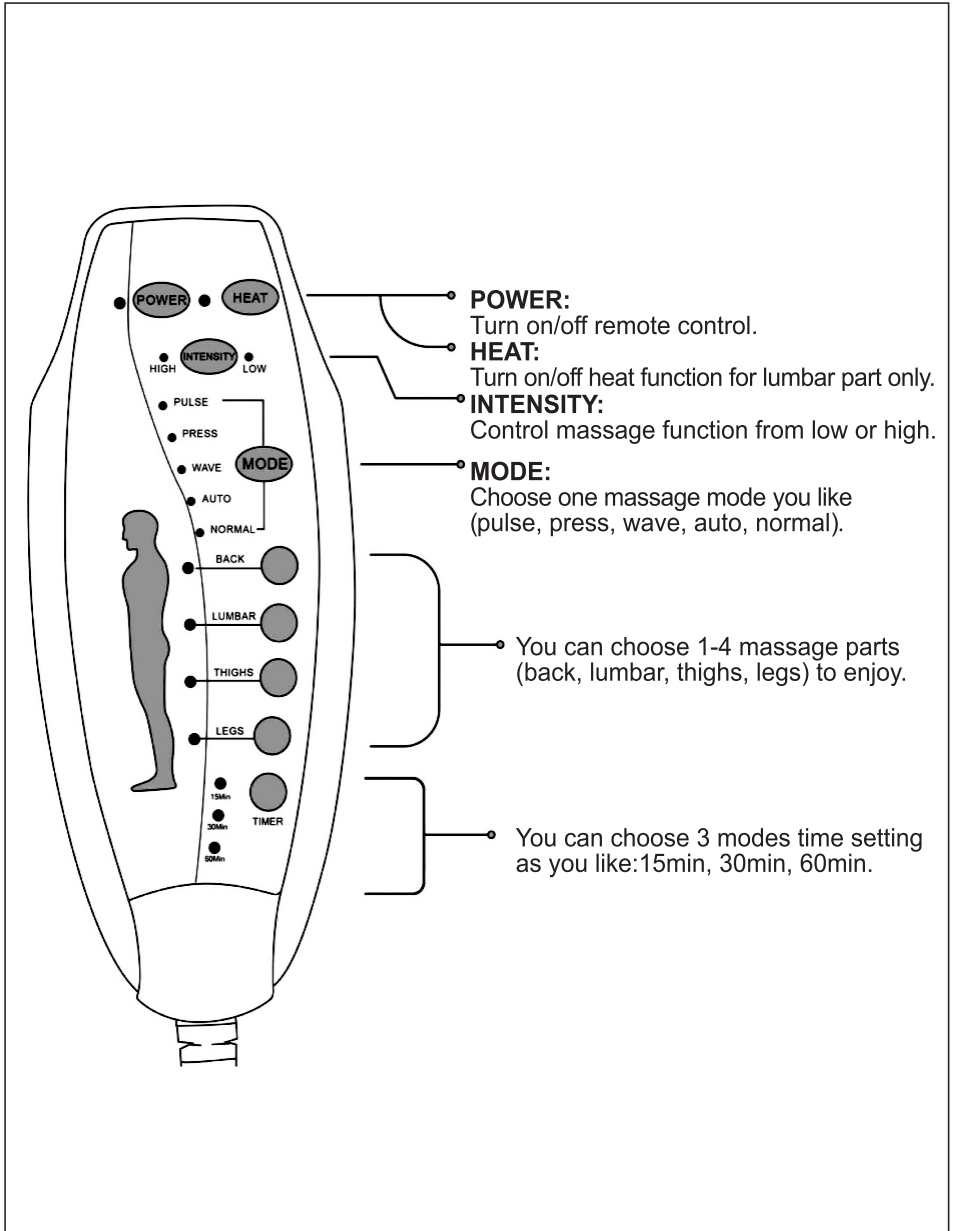

# WARRANTY

1. We strive to offer high-quality products, and we also try our best to satisfy each and every customer that orders from us with product or service as needed.
2. We provide 30 days warranty starting from the time you receive the item. Each customer must provide a record of their order such as the order number, or item receipt for any items that are out of the warranty period you may also still receive:
3. Replacement parts by purchasing them with our company if they are available.