

# WARNING!!

Children have died from furniture tip overs. Tip restraints have been included with this product; you must install the tip restraints according to these instructions in order to minimize the risk of furniture tipping. If you have any questions about this product or the tip restraint, please send us an email at our website.

NEVER allow children to climb or hang on furniture, including drawers or cabinet doors.

In addition to installing the restrains, to help prevent tip-overs

1. **NEVER** put a **TV** or other heavy objects on top of this product".
2. Do not stand on the products.

⚠ <b>WARNING</b>	
	<p><b>Children have died from furniture tipover. To reduce the risk of furniture tipover:</b></p> <ul style="list-style-type: none"><li>• ALWAYS install tipover restraint provided.</li><li>• NEVER put a TV on this product.</li><li>• NEVER allow children to stand, climb or hang on drawers, doors or shelves.</li><li>• NEVER open more than one drawer at a time.</li><li>• Place heaviest items in the lowest drawers.</li><li>• Do not defeat or remove the drawer interlock system.</li></ul>
	<p><i>This is a permanent label. Do not remove!</i></p>



# Assembly Instructions

**Caution : You must read this before you proceed**

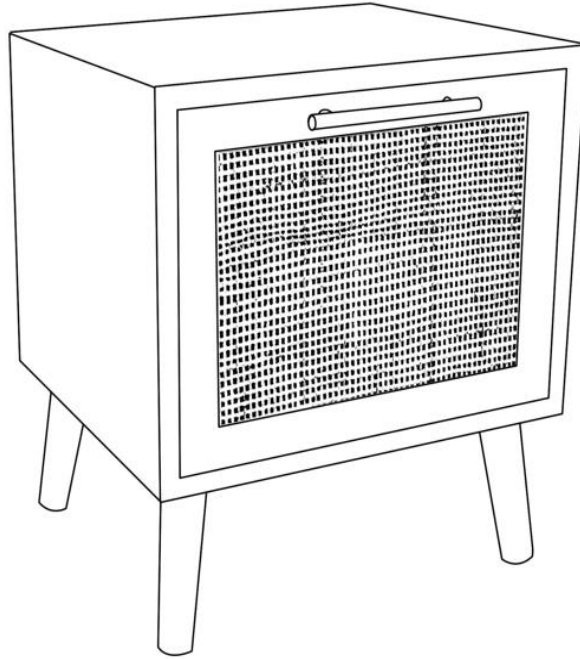

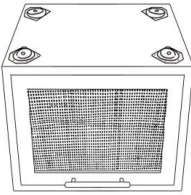

## Table

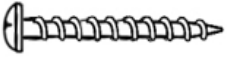
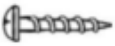

## Parts List

Label	Picture	Description	QTY
A		Table Body	1
B		Leg	4

# Hardware

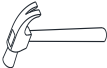
Label	Picture	Description	QTY
①		Adjustable Leveller	5
<b>Restraint Device Hardware</b>			
②		Screw (M4*40mm)	1
③		Screw (M4*16mm)	1
④		Wall Anchor	1
⑤		Restraint Strap	1
⑥		Power Drill (not provided)	1
⑦		Hammer (not provided)	1

# Assembly Preparation

Before Beginning Assembly:

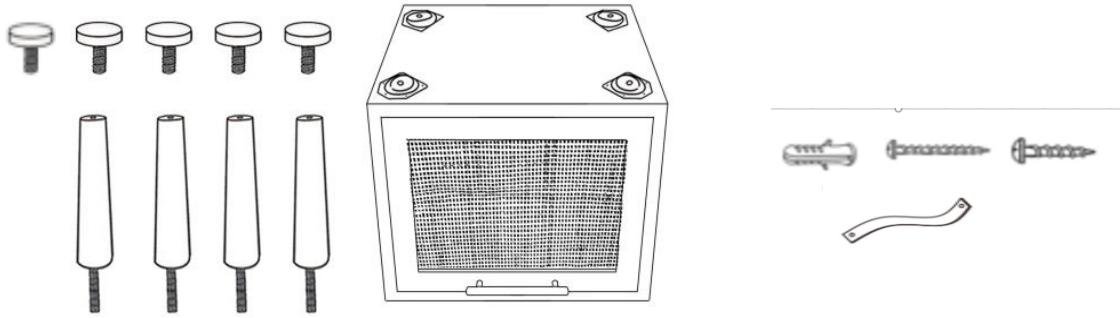

- Read instructions, cover to cover-



- Have 2 adults on hand for assembly-



- Do not assemble on flooring or carpet-



- Assemble on a clean non-marring surface (packing foam)-



- Save all packaging until finished-

# Assembly Steps

## Overview

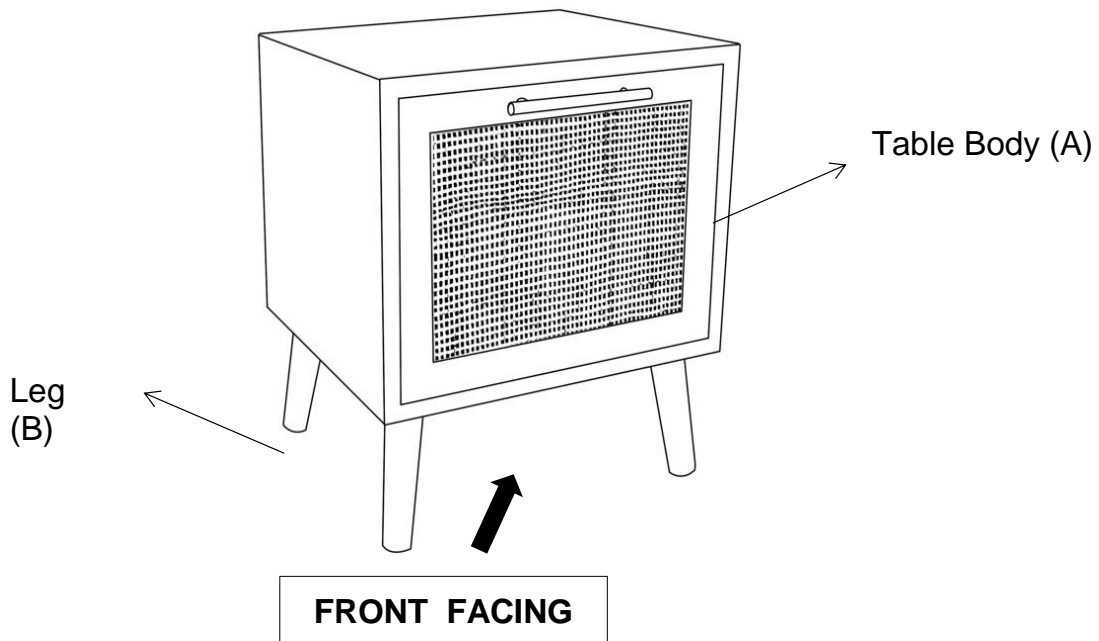

This Table has multiple parts and may require up to some 30 minutes to assemble. To give you an overview of the Table parts, the above picture is to help you put the various parts into perspective. Please read through the instructions here below to familiarise yourself with the parts and steps before assembly.

### Step 1

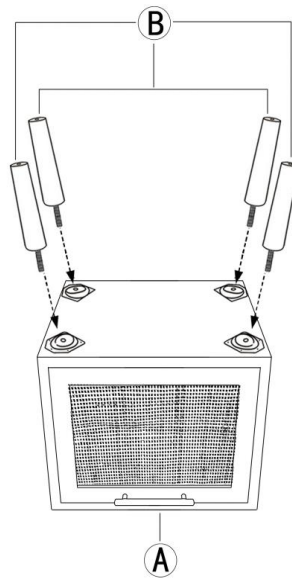

Place the Table Body(A) on a clean, non-marring surface.  
Attach the Legs(B) to the Table Body(A) by hand.

### Step 2

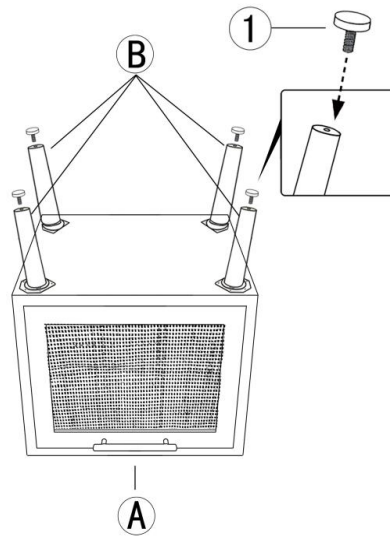

Attach the Adjustable Levellers(①) to the Legs(B) by hand.

### Step 3

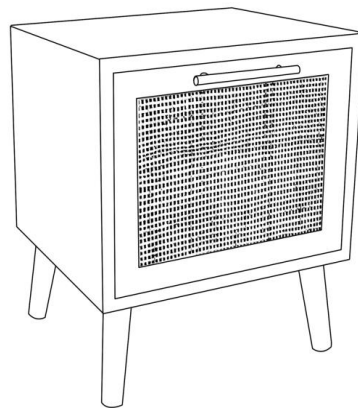

Turn the Table right side up.  
Your Table is ready for use.

**Caution: This Table can only be used on a flat, level surface.**

# Tipover Restraint Device Installation Instruction



Serious or fatal crushing injuries can occur from tipping furniture.  
**To help prevent tip-over: ALWAYS secure this furniture to the wall using the Restraint Device.**

See product instructions for more ways to help prevent furniture tip-over.

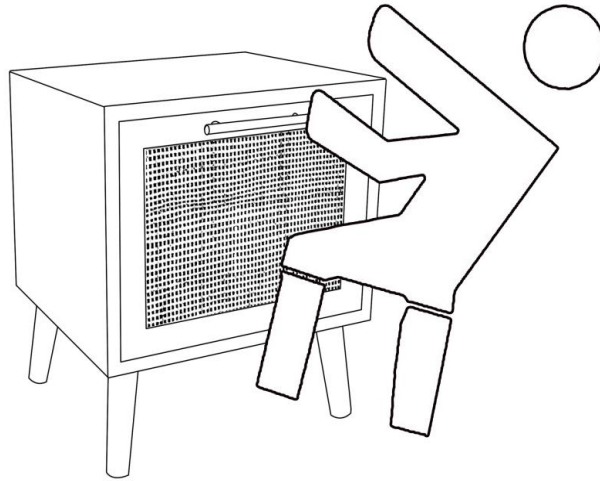

## **Usage For Table Restraint Device:**

To secure the Table against wall, attach one end of the **Restraint Strap(5)** to the wall and the other end of the **Restraint Strap(5)** to the product.

### Step 1

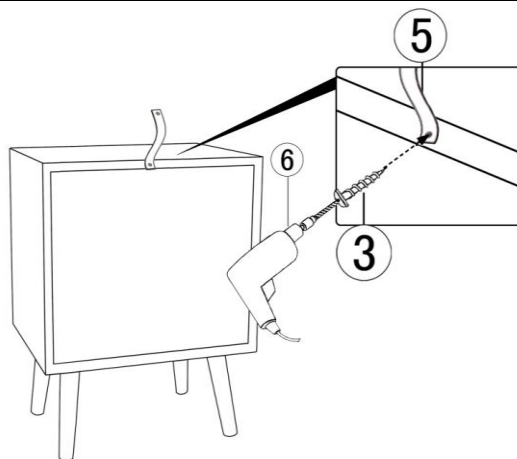

Turn the Table so the back faces you.

Attach a Restraint Strap(5) to the back of Table Body(A), where labeled, using a Bracket Screw(3) and a Power Drill(6).

## Step 2

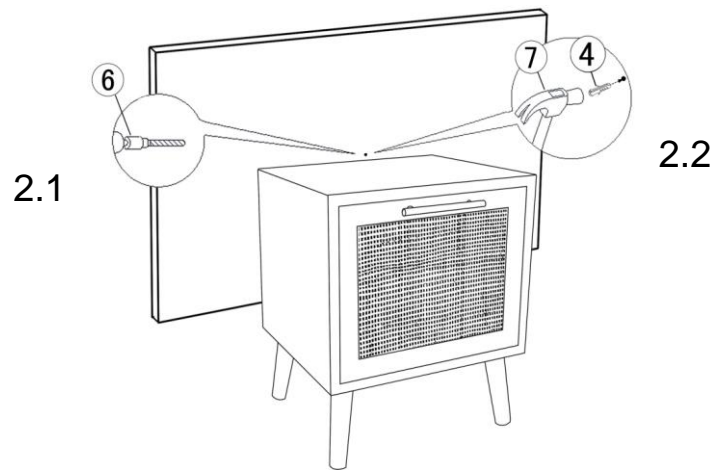

2.1) Drill **one hole** on the wall at the same height as the **Restraint Strap(5)** on the Table using a Power Drill(6).

**You can mark this point in two ways as below:**

1) Move the Table back to the wall. Mark one point the same height as the Table on the wall.

**Note: The Restraint Strap needs to be secured to a solid, load bearing surface. Please use a Stud Finder(not supplied) if needed to locate the Wall Frame.**

2) Measure the height of the **Restraint Strap(5)** with a ruler/measuring tape and mark on the wall to keep them accurate and at the same height.

2.2) Attach a Wall Anchor (4) to the hole on the wall using a Hammer(7).

## Step 3

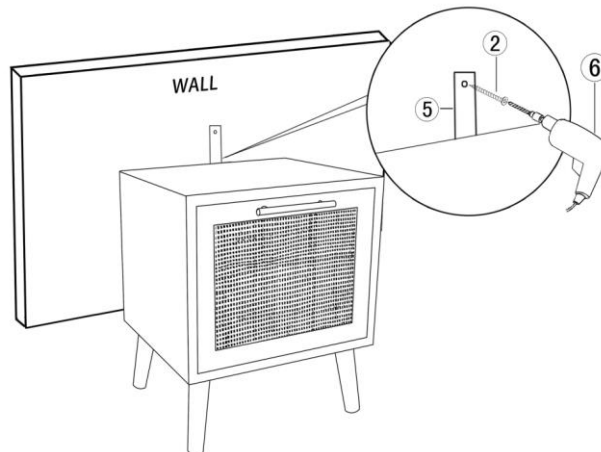

Attach the Restraint Strap(5) to the Wall Anchor (4) using a Screw(2) and the Power Drill(6)

Your Table is ready for use.

**Caution: This Table can only be used on a flat, level surface.**

## Care & Maintenance



- Furniture may scratch floors. We recommend using furniture pads to protect your floors.



- Do not put hot items directly on furniture surface.



- Do not clean furniture with harsh cleansers or polish.



- Do not place furniture under direct sunlight.



- Do not place furniture near heating or cooling vents.



- Do not write on furniture without a padded barrier to protect the surface.



- Do not place furniture outside . For indoor use only.



- Not for commercial use. For residential use only.



- Stains may be removed with mild soap solution and damp cloth.



- Children should not climb or jump on the furniture.



- Dust and pick-up spills using a clean, non-colored, lint-free cloth.