

# SOU3300TX



Category	30"
Product family	Oven
Power supply	Electrical
Power supply	Electricity
Cooking method	Thermo-ventilated
Cleaning system	VaporClean
EAN code	8017709304027



## Aesthetic

<b>Aesthetics</b>	Classic	<b>Stainless steel type</b>	Brushed
<b>Color</b>	Stainless steel	<b>Silkscreen color</b>	Black
<b>Finishing</b>	Fingerprint-proof	<b>Silkscreen type</b>	Symbols and wordings
<b>Design</b>	Flat	<b>Logo</b>	Embossed
<b>Material</b>	Stainless steel		

## Controls



<b>Display name</b>	DigiScreen	<b>No. of controls</b>	2
<b>Display technology</b>	LED		

## Programs / Functions

**No. of cooking functions** 9  
**Traditional cooking functions**

Static	Fan-assisted	True European convection
Turbo	Large grill	Fan grill (small)
Fan grill (large)	Bottom	Convection bottom

### Other functions



### Cleaning functions

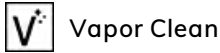

## Options

Time-setting options	Delayed start and automatic shut-off when cooking ends	Timer	1
Minute minder	Yes		

## Technical Features



Minimum Temperature	100 °F	Large grill - Power	2900 W
Maximum temperature	500 °F	Circular heating element - Power	2500 W
No. of shelves	6	Heating elements stop when door is opened	Yes
Fan	Single	Door	Cool-touch door
No. of lights	2	Removable inner door	Yes
Lighting	Halogen	Total no. of door glasses	3
Replaceable light	Yes	Cooling system	Tangential
Light power	40 W	Cooling duct	Double
Light on when door is open	Yes	Cooling System Speed Reduction	Yes
Lower heating element power	1700 W	Temperature control	Electro-mechanical
Upper heating element - Power	1200 W	Cavity material	EverClean enamel
Grill element - power	1700 W		

## Performance / Energy Label

Volume of the cavity	3.92 cu. ft.
----------------------	--------------

## Accessories Included

Rack with back stop	2
---------------------	---

## Electrical Connection

Voltage	230 V	Current	14 A
Nominal power	3700 W	Frequency	60 Hz
Voltage	120/208 V	Power cord length	45 1/4 "

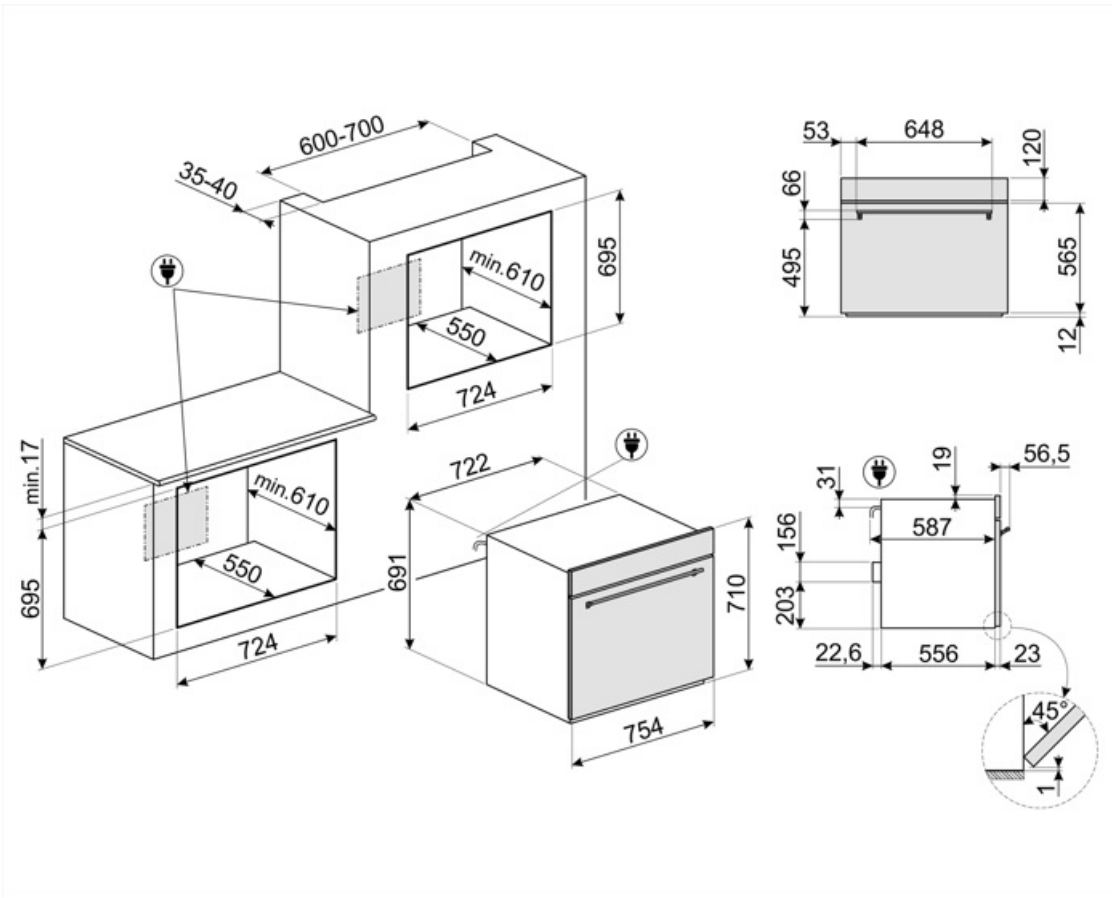

---

## Compatible Accessories

---

### KITUH30

KIT Usa Height 30'oven , from 27' 3/8 to 27' 15/16 niche height

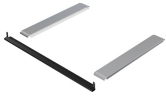

















### STONE

Rectangular refractory stone PPR2. Ideal for cooking pizzas with the same results as a typical wood-fired oven. Can also be used for baking bread, focaccias and other recipes such as pies, flans or biscuits Dimensions:L42 x H1,8 x P37,5 cm.



## Symbols glossary

 <p>A: Product drying performance, measured from A+++ to D / G depending on the product family</p>	 <p>Air cooling system: to ensure a safe surface temperatures.</p>
 <p>With the switch on this symbol, no heating is possible even if the thermostat is turned.</p>	 <p>...</p>
 <p>Triple glazed doors: Number of glazed doors.</p>	 <p>Electric</p>
 <p>Enamel interior: The enamel interior of all Smeg ovens have a special antacid lining which helps keep the interior clean by reducing the amount of cooking grease adhering to it.</p>	 <p>Fingerprint proof stainless steel: Fingerprint proof stainless steel keeps stainless steel looking as good as new.</p>
 <p>Circogas: In gas ovens the fan distributes the heat quickly and evenly throughout the oven cavity, avoiding flavour transfer when cooking a number of different dishes at the same time. In electric ovens this combination completes cooking more quickly of foods that are ready on the surface, but that require more cooking inside, without further browning.</p>	 <p>Fan with upper and lower elements: The elements combined with the fan aim to provide more uniform heat, a similar method to conventional cooking, so pre-heat is required. Most suitable for items requiring slow cooking methods.</p>
 <p>Upper and lower element only: a traditional cooking method best suited for single items located in the centre of the oven. the top pf the oven will always be hottest. Ideal for roast, fruit cakes, bread etc.</p>	 <p>Lower heating element only: This function is ideal for foods that require extra base temperature without browning, e.g. pastry dishes, pizza. Also suitable for slow cooking of stews and casseroles.</p>
 <p>True European Convection: The combination of the fan and circular heating element around it provides many benefits, including no preheat if cooking time is longer than 20 minutes, no flavor transfer when cooking different foods at the same time, lower energy consumption, and shorter cooking times. Suitable for all types of food preparations.</p>	 <p>Fan with grill element: The fan reduces the fierce heat from the grill, providing an excellent method of grilling various foods, chops, steaks, sausages etc. giving even browning and heat distribution, without drying out the food. The top two levels recommended for use, and the lower part of the oven can be used to keep items warm at the same time, an excellent facility when cooking a grilled breakfast. Half grill (centre portion only) is ideal for small quantities of food.</p>
 <p>Grill element: Using of grill gives excellent results when cooking meat of medium and small portions, especially when combined with a rotisserie (where possible). Also ideal for cooking sausages and bacon.</p>	 <p>Fan with grill element: The fan reduces the fierce heat from the grill, providing an excellent method of grilling various foods, chops, steaks, sausages etc. giving even browning and heat distribution, without drying out the food. The top two levels recommended for use, and the lower part of the oven can be used to keep items warm at the same time, an excellent facility when cooking a grilled breakfast. Half grill (centre portion only) is ideal for small quantities of food.</p>



**Circulaire with upper and lower elements:** The use of the fan with both elements allows food to be cooked quickly and effectively, ideal for large joints that require thorough cooking. It offers a similar result to rotisserie, moving the heat around the food, instead of moving the food itself, enabling any size or shape to be cooked.



**All glass inner door:** All glass inner door, a single flat surface which is simple to keep clean.



**The inner door glass:** can be removed with a few quick movements for cleaning.



**Side lights:** Two opposing side lights increase visibility inside the oven.



**The oven cavity has 6 different cooking levels.**



**Vapor Clean:** a simple cleaning function using steam to loosen deposits in the oven cavity.



**The capacity indicates the amount of usable space in the oven cavity in litres.**