

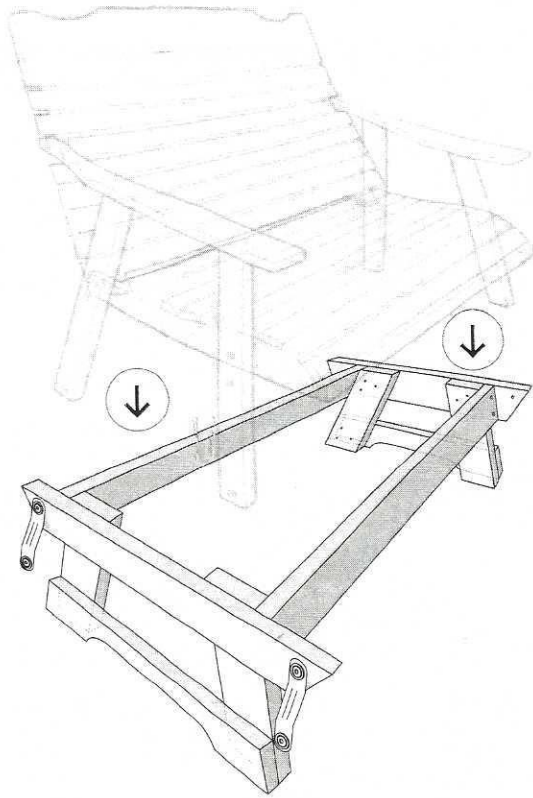



Glider Base



Assembly Instructions



Parts List

	8	5/16" x 2 1/2" Machine Bolts
	8	#8 x 2 1/2" Screws
	16	5/16" Washers
	8	5/16" Locking Nuts

Tools Required

	1/2" Wrench
	Hammer

1. Base Assembly

Place base on a flat surface.

Attach the 2 base cross pieces onto base with 2-1/2" screws into the pre-drilled holes and tighten.

Repeat process on other side.

2. Gliding Brace Attachment

Place a 5/16" washer on a 2-1/2" machine bolt and insert through inside top hole of base assembly. Place a 5/16" washer on bolt before gliding brace and 5/16" locking nut. Tighten.

Repeat process for the other 3 holes in assembly.

