

LAMINATE SHELVING

installation instructions

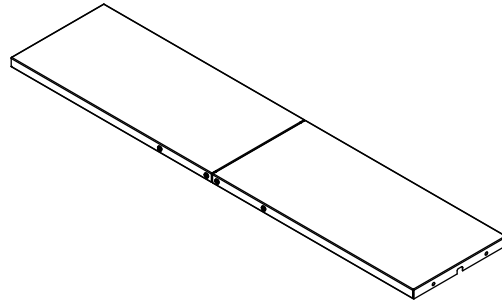

PARTS LIST

No.	Parts No.	Name	Material	Quantity	Specifications(mm)
1	A	Laminate shelving	metal	2	647.5x300x25
2	B	Connecting rod	metal	2	400X12x22
3	C	Large flat head cross screw	304	5	M6x16
4	D	Cross flat head screws	304	9	M6x12
5	E	Fastening nut	304	9	M6

TOOLS REQUIRED



Screwdriver



Adjustable wrench

HARDWARE

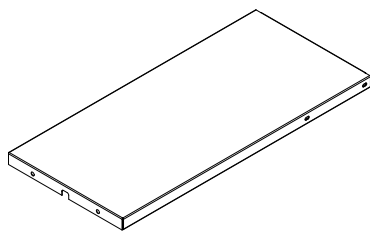

Laminate shelving
A

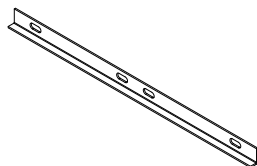

Connecting rod
B

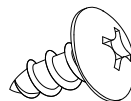

Large flat head
cross screw
C
M6X16x4pcs

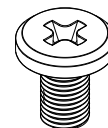

Cross flat head screws
D
M6x12x8pcs

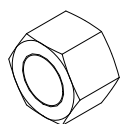

Fastening nut
E
M6x8pcs

1

Laminate shelving installation

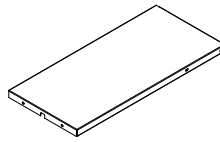

Laminate shelving
A

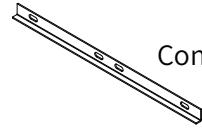

Connecting rod
Bx2pcs

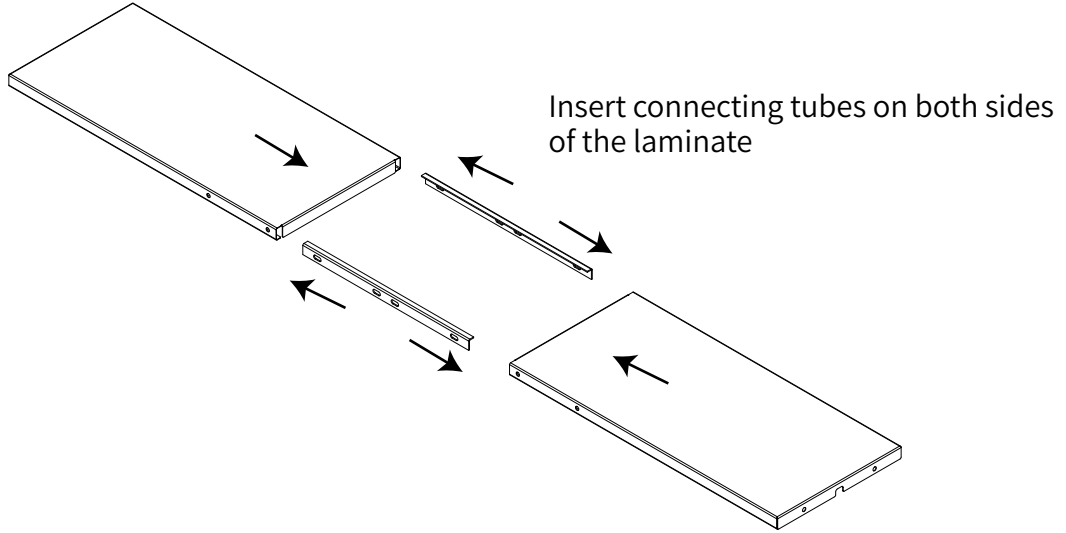

2

Laminate shelving installation



Cross flat head screws
D
M6x12x8pcs

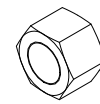

Fastening nut
E
M6x8pcs

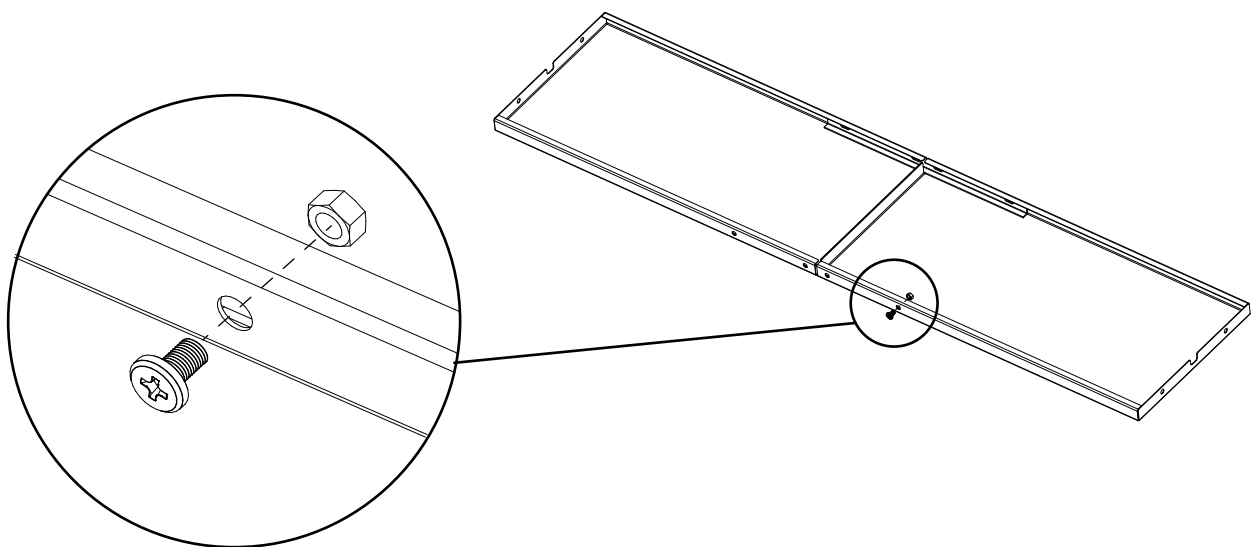

note: right and left same installation method.

3

Laminate shelving installation

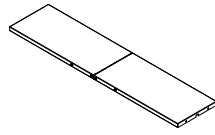

Laminate shelving A



Large flat head cross screw C
M6x16x4pcs

1

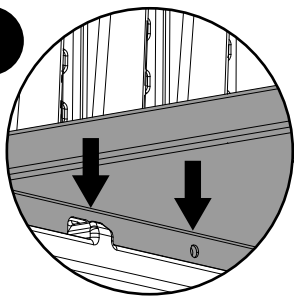

2

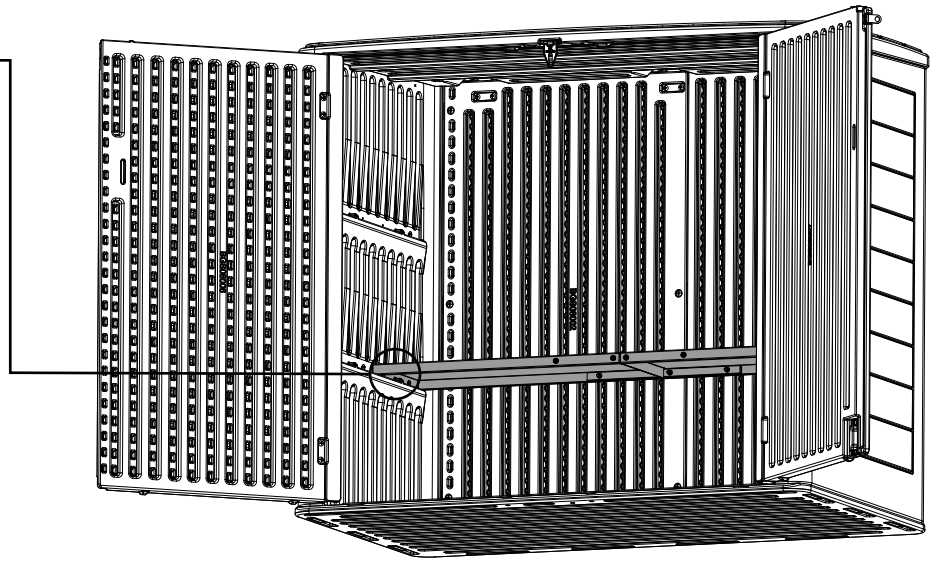
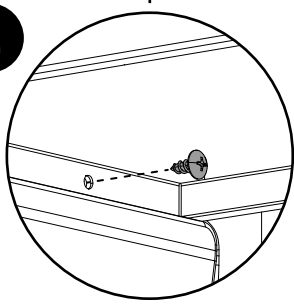

note: right and left same installation method.

4

Laminate shelving installation

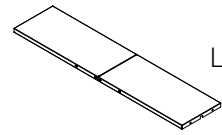

Laminate shelving A



Large flat head cross screw C
M6x16x4pcs

1

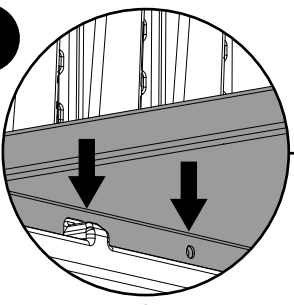

2

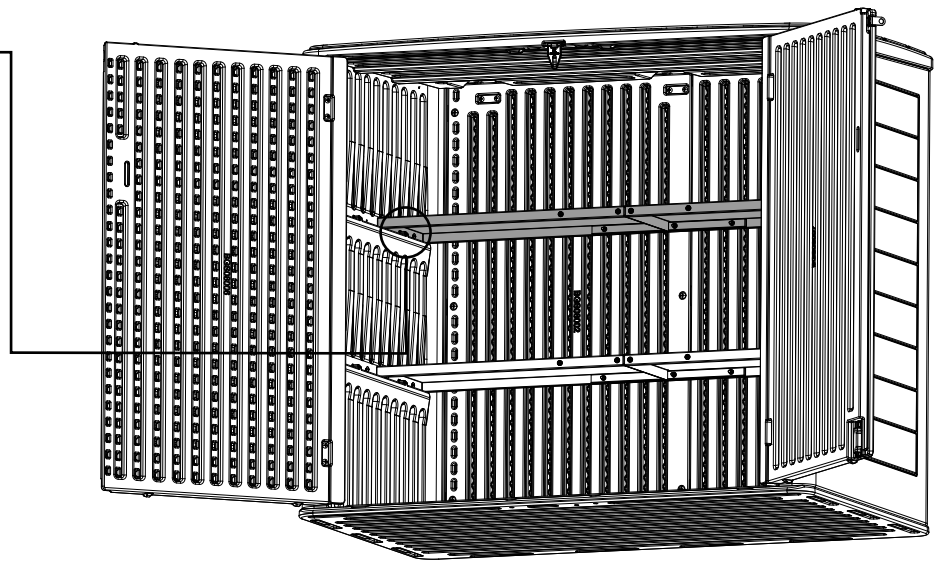
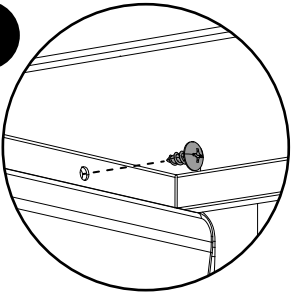

note: right and left same installation method.

5

Laminate shelving installation

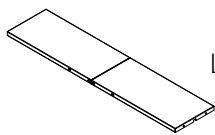

Laminate shelving A



Large flat head cross screw C
M6x16x4pcs

1

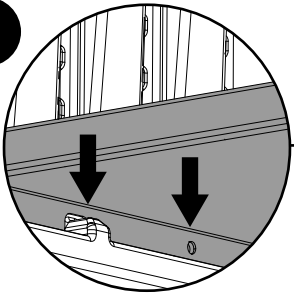

2

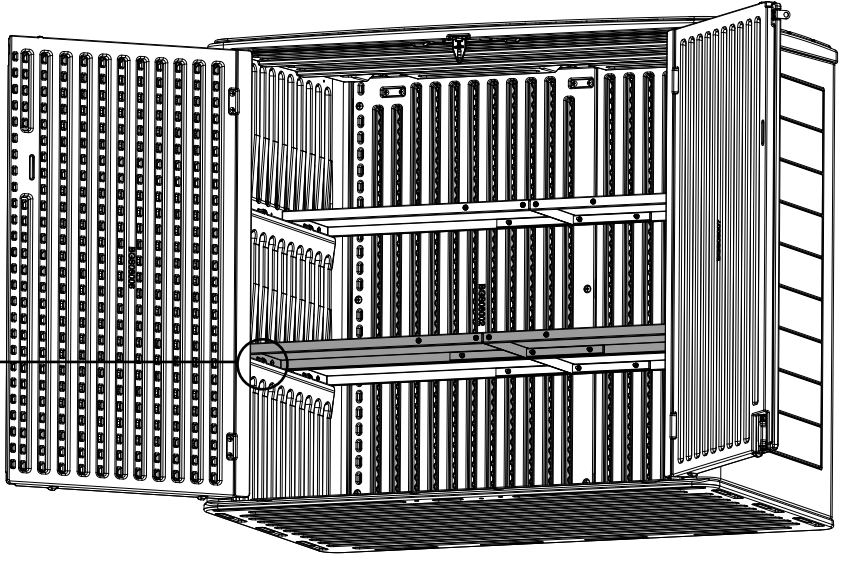
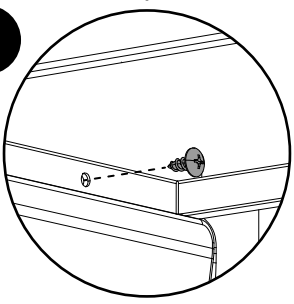

note: right and left same installation method.

6

Laminate shelving installation

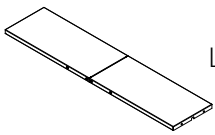

Laminate shelving A



Large flat head cross screw C
M6x16x4pcs

1

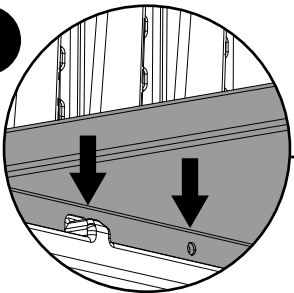

2

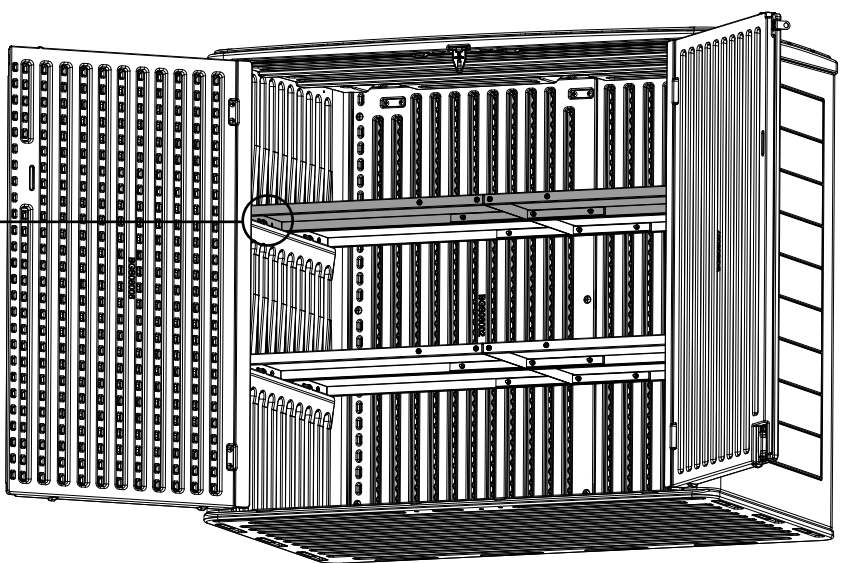
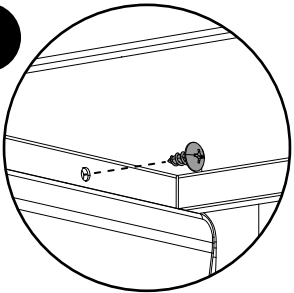

note: right and left same installation method.

👍 Congratulations! you did it!! Awesome!!!