

# ASSEMBLY INSTRUCTIONS

---

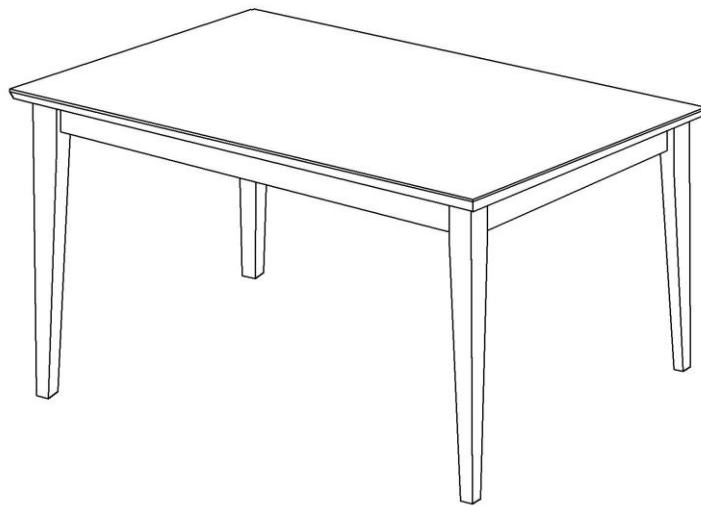
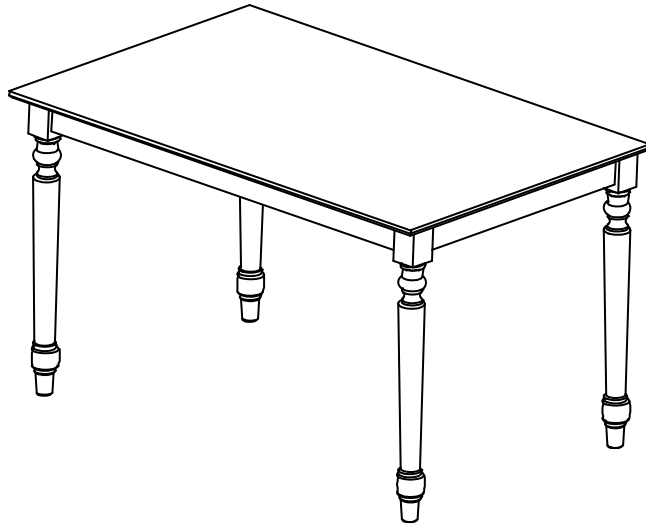

---

Description : FIXED TOP TABLE

## BEFORE ASSEMBLY

Thank you for purchasing this quality product. This product has been designed for easy assembly and constructed for durability. All parts were checked prior to packaging to insure quality. Prior to beginning assembly, however, make sure all parts and hardware are included and free of obvious defect. If a part is missing or defective, please contact the store where purchased. If hardware is missing, or you need help with assembly, please call toll free 888-944-8396.

### **IMPORTANT NOTE:**

- Place all wooden parts on a clean and smooth surface such as a rug or carpet to avoid the parts from being scratched.
- Remove all wrapping material, including staples & packing straps before you start to assemble.
- DO NOT tighten all screws and bolts until completely assembled.
- Keep all hardware parts out of reach of children.

### **WARNING:**

Long exposure to rubber or soft plastic may cause a chemical reaction and damage the finish of your table. Protect the surface of the table with cloth if you are using any product with rubber feet or base.

## PART LIST T-3030T, T-3042T, T-3048T, T-3636T, T-4242T

When unpacking, please be careful not to discard any parts with the packaging. Before continuing, please make sure you have the following parts:

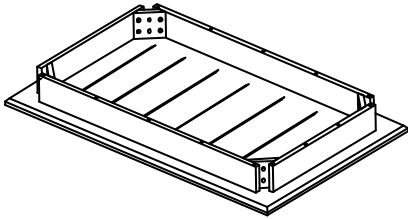
| NO | Description | Qty | Sketch   |
|----|-------------|-----|--|
| A  | Table top   | 1   |  |

## PART LIST T-18S, T-30S, T-36S, T-42S

When unpacking, please be careful not to discard any parts with the packaging. Before continuing, please make sure you have the following parts:

| NO | Description | Qty | Sketch   |
|----|-------------|-----|--|
| B  | Shaker legs | 4   |  |



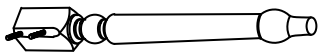

## OR PART LIST T-330T, T-336T, T-342T

When unpacking, please be careful not to discard any parts with the packaging. Before continuing, please make sure you have the following parts:

| NO | Description | Qty | Sketch   |
|----|-------------|-----|--|
| B  | Turned legs | 4   |  |

## HARDWARE LIST

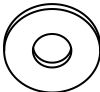
When unpacking, please be careful not to discard any parts with the packaging. Before continuing, please make sure you have all of the following hardware:

| NO | Description  | Qty | Sketch  | NO | Description   | Qty | Sketch  |
|----|--|-----|---|----|---|-----|---|
| 1  | Hexagon nut<br>(M8 x 13mm)                               | 8   |  | 3  | Lock washer<br>( $\Phi 8.5 \times \Phi 13\text{mm}$ ) | 8   |  |
| 2  | Flat washer<br>(2 x $\Phi 8.5 \times \Phi 22\text{mm}$ ) | 8   |  | 4  | Wrench<br>(13mm)                                      | 1   |  |

**NOTE: HARDWARE IS PACKED IN CARTON OF LEGS T-330T, T-336T, T-342T OR T-18S, T-30S, T-36S, T-42T.**

# STEP 1

Attach legs (B) to top (A) with washers (2), and (3) and nuts (1) as shown below. Tighten with the wrench (4).

