

# ASSEMBLY INSTRUCTIONS

## SECTIONAL

Caution: Please read instructions thoroughly before unpacking assembly parts. Sharp, exposed staple tips can cause injury, therefore, for your protection, please remove any exposed staple used in packing

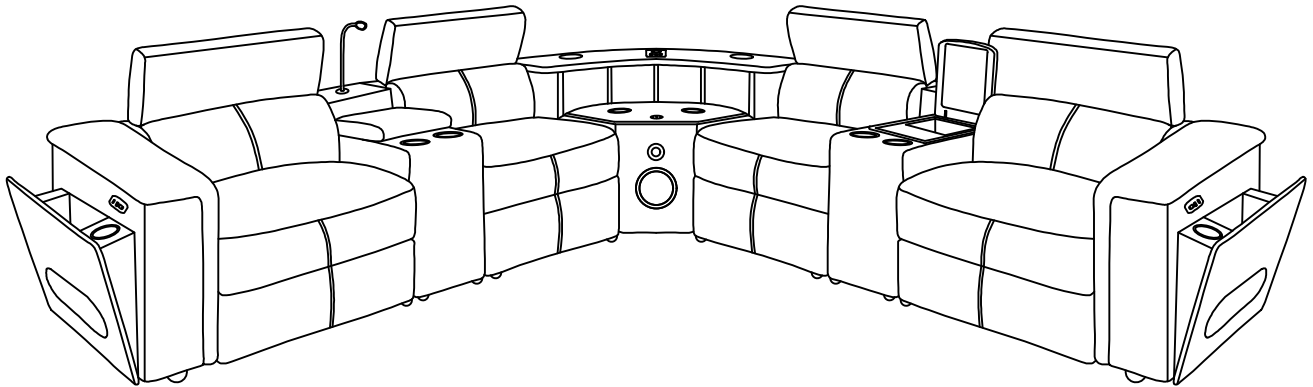









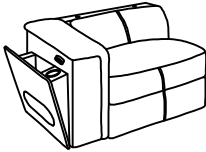







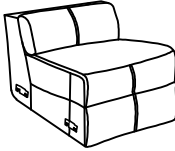

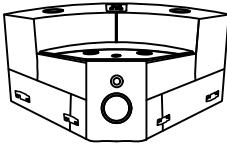

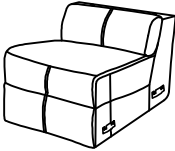

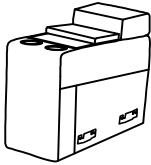
### PARTS LIST

NO	SKETCH	QTY	DESCRIPTION	NO	SKETCH	QTY	DESCRIPTION
A		1PC	Left Power Recliner	E		1PC	Console With Refrigerator
B		1PC	Console With Touch Light	F		1PC	Right Power Recliner
C		2PCS	Armless Chair	G		4PCS	Head rest
D		1PC	Wedge With Lifting Wine Cabinet				

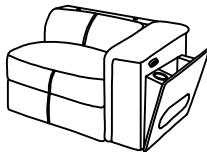
### HARDWARE LIST

NO	SKETCH	QTY	DESCRIPTION	NO	SKETCH	QTY	DESCRIPTION
K		2PCS	Adapter of L/R Power Recliner	P		1PC	Adapter of Bluetooth Speaker
L		2PCS	Plug With Wire of L/R Power Recliner	Q		1PC	Adapter of Refrigerator
M		1PC	Touch Light	U		1PC	Plug With Wire of Refrigerator
N		1PC	Adapter of Touch Light	T		24PCS	Legs
O		1PC	Plug With Wire of Wine Cabinet				

CARTON	DESCRIPTION	PART	HARDWARE
01	Left Power Recliner With Armrest STG And Led Light		 G x 1PC  K x 1PC  L x 1PC  T x 4PCS
02	Console With Cup And Touch Light		 M x 1PC  N x 1PC  T x 4PCS
03	Armless Chair		 G x 1PC  T x 4PCS
04	Wedge With Bluetooth Speaker, Led Light And Lifting Wine Cabinet		 O x 1PC  P x 1PC
05	Armless Chair		 G x 1PC  T x 4PCS
06	Console With Cup/ Refrigeration System Of Refrigerator/Wireless Charger		 Q x 1PC  U x 1PC  T x 4PCS
07	Right Power Recliner With Armrest STG And Led Light		 G x 1PC  K x 1PC  L x 1PC  T x 4PCS

**STEP 1#** Attach the legs (T) into the Left (A) And Right(F) Power Recliner, as shown below.

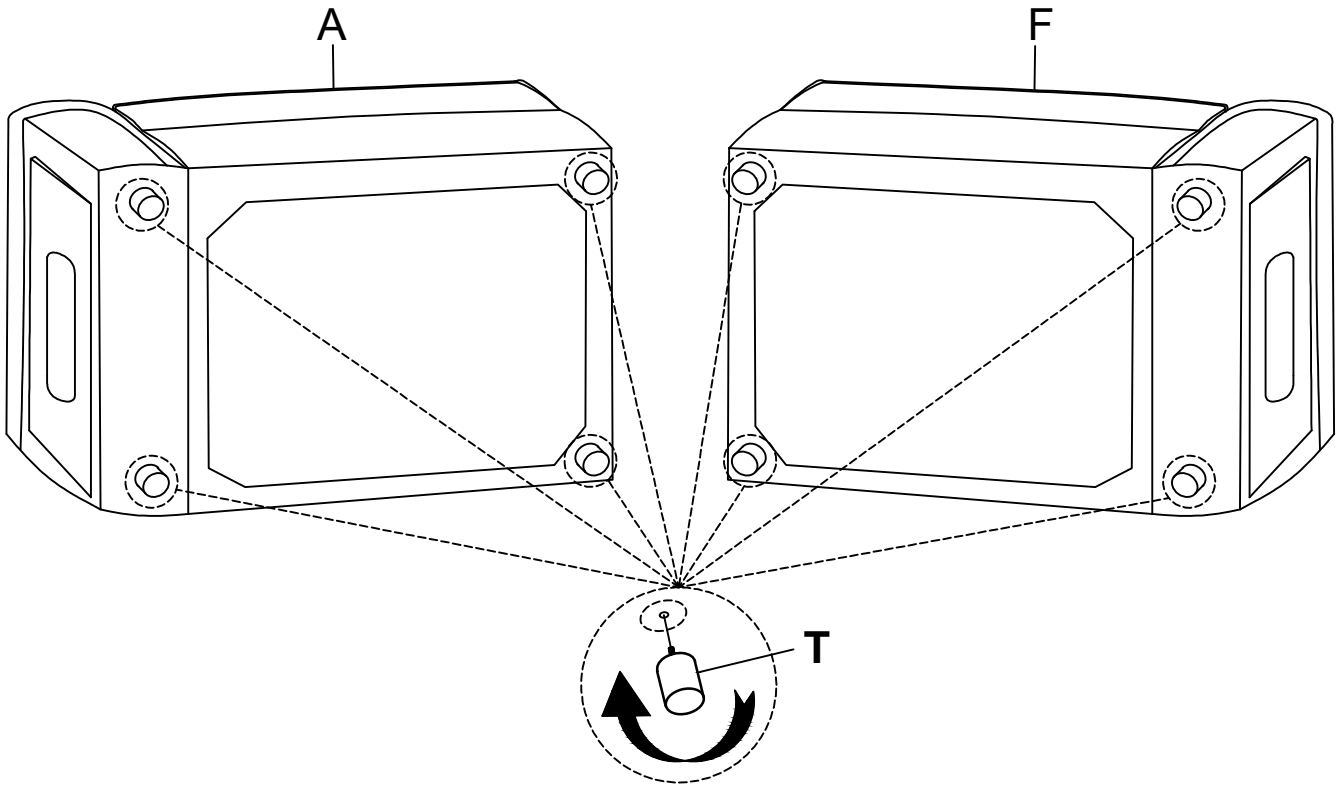

**STEP 2#** Attach the legs (T) into the Console With Touch Light (B) And the Console With Refrigerator (E), as shown below.

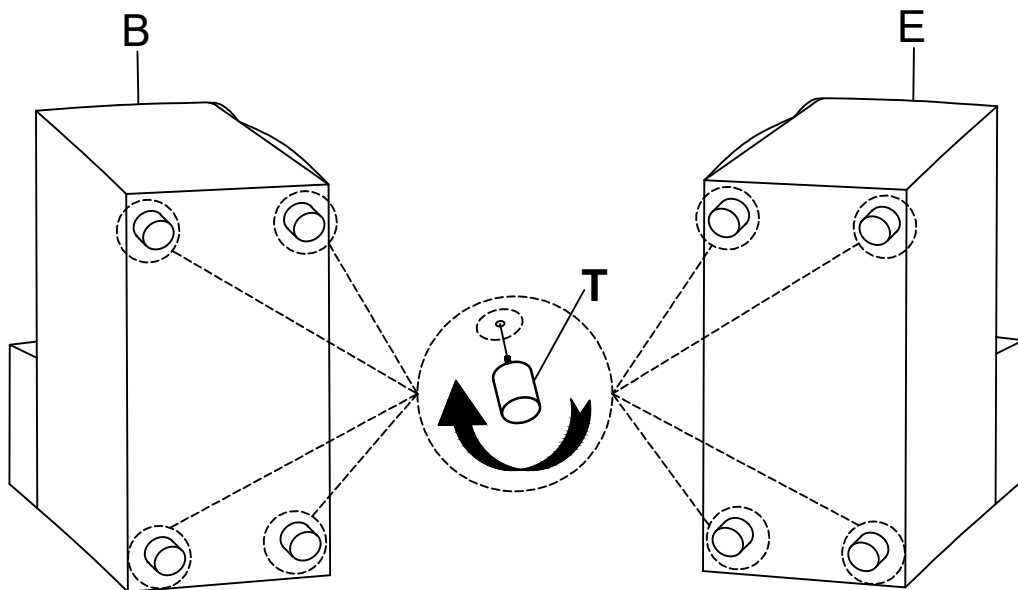

**STEP 3#** Attach the legs (T) into the Armless Chair (C), as shown below.

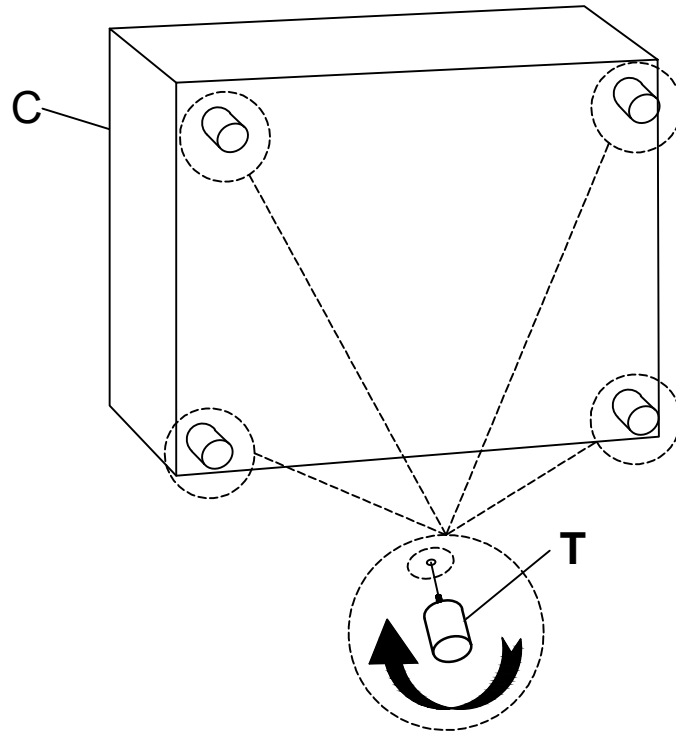

**STEP 4#** Connect the Left Power Recliner (A), Console With Touch Light (B), Armless Chair (C), Wedge With Lifting Wine Cabinet (D), Console With Refrigerator (E) and Right Power Recliner (F) together as shown below diagram.

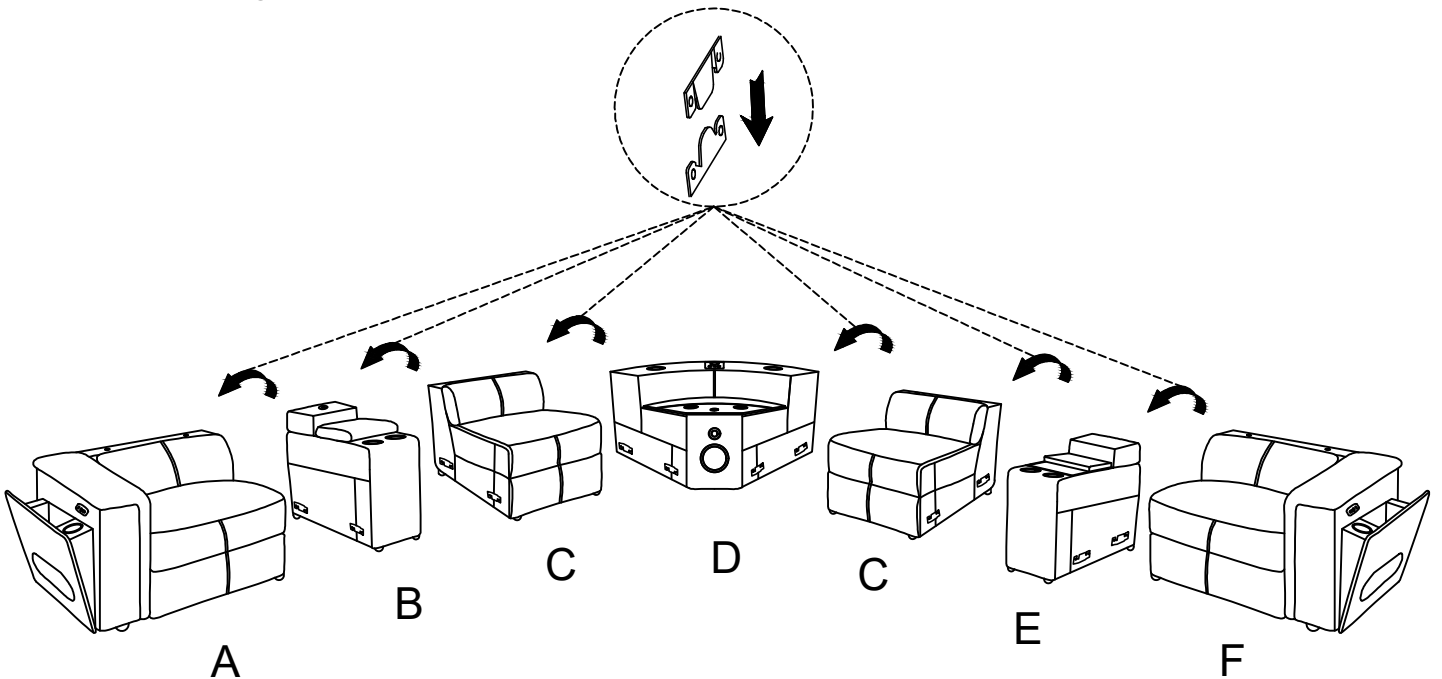

**STEP 5#** Attach the Back rest (G) into the Left Power Recliner (A), Armless Chair (C) and Right Power Recliner (F), as shown below. Attach the Touch Light (M) into the Console With Touch Light (B), as shown below.

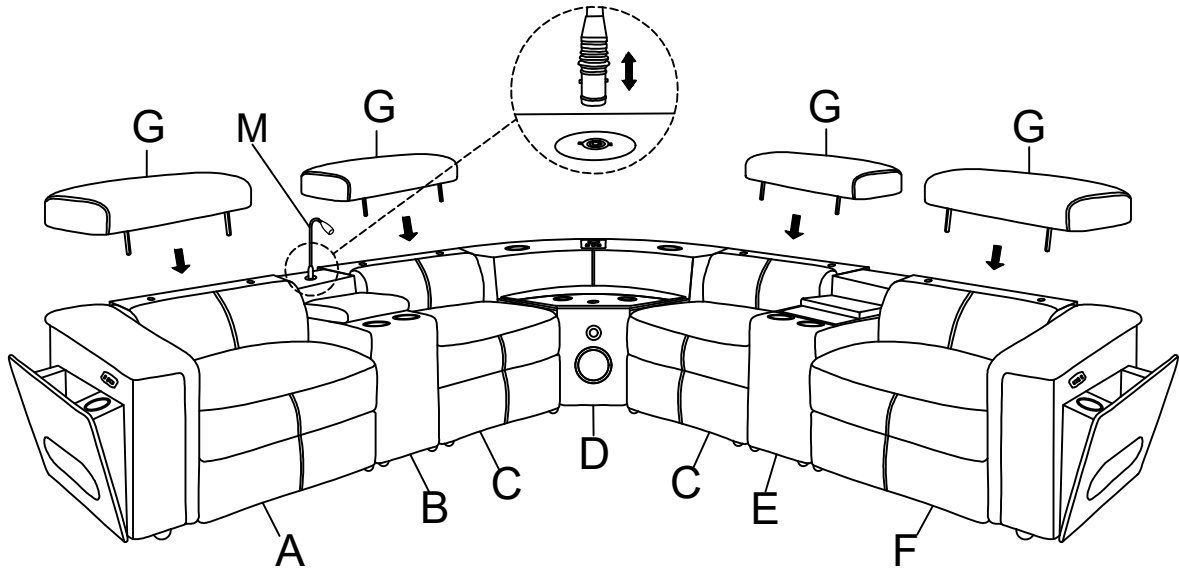

**STEP 6#** Connect all power sources and turn on the chair functions, as shown below diagram.

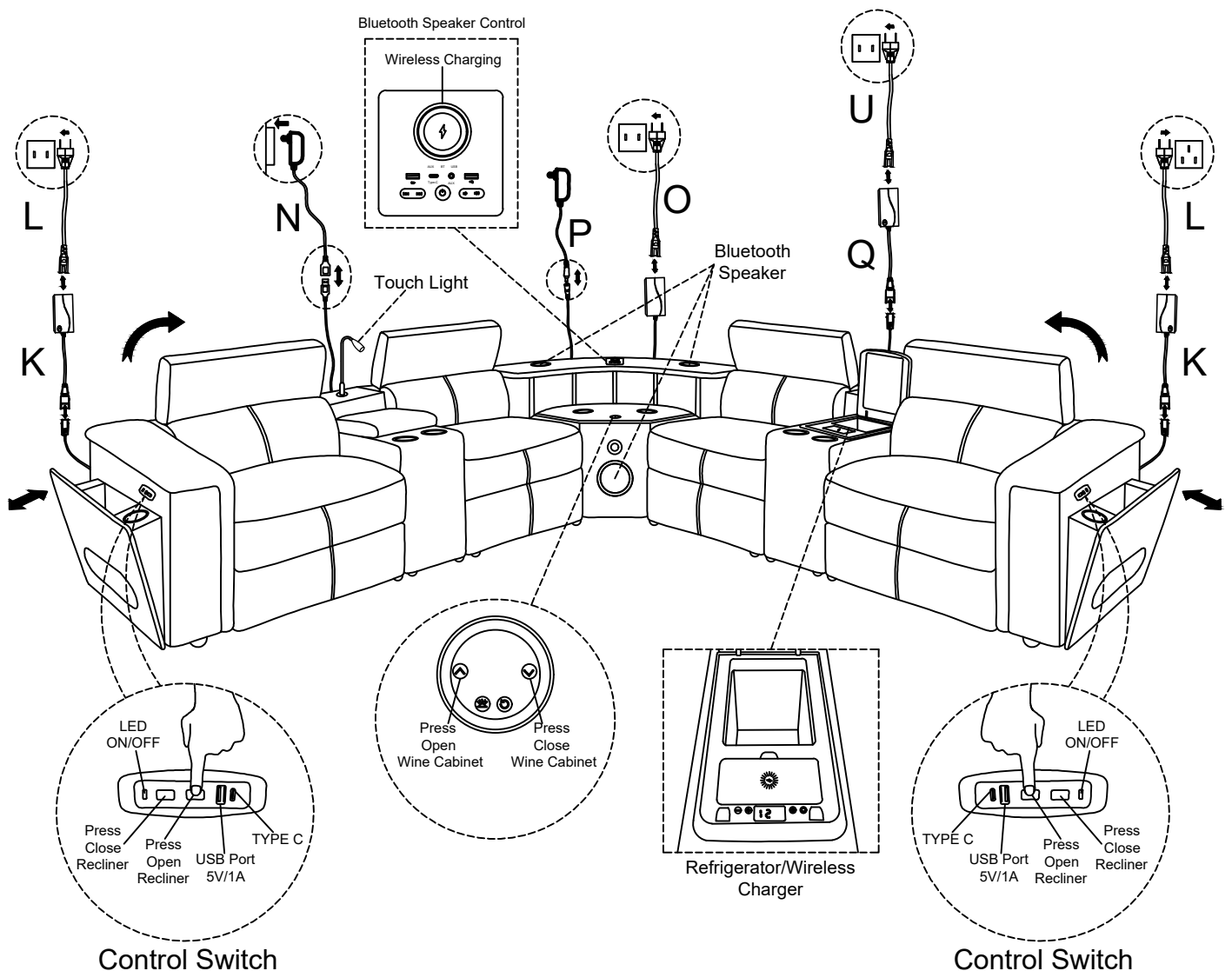



- Disconnect the electrical plug from the wall outlet before cleaning, moving, servicing or when not in use for an extended period of time.
- Plug directly into a wall outlet. Do not use an extension cord or adaptor
- Check the condition of the power transformers, electrical cords, plugs and connectors monthly. Keep the power adaptor and electrical cords away from heat sources. Never operate the unit with a damaged power adaptor, electrical cord, plug or connector.
- Before moving the product, please disconnect the electrical plug from the wall outlet and secure the mechanism to prevent unexpected opening or movement. Never move the product by the mechanism, legrest, handle, or reclining back. Do not attempt to disassemble or service the adaptor or motor. No serviceable parts are inside.
- Do not allow electrical cord to be pinched between moving parts or between the frame and the floor.
- Do not place cord under carpet or in location where it could become worn.
- Unplug the power cord immediately if you detect strange odors or fumes coming from the chair.

**PLEASE KEEP ASSEMBLY INSTRUCTION FOR FUTURE REFERENCE**