

Claim your extended 90 day product warranty by registering your product

**ATTENTION: DO NOT RETURN THIS PRODUCT!!!
PLEASE READ THE FOLLOWING!!!**

**NOTICE REGARDING HIGH GLOSS
PROTECTIVE FOIL AND PRODUCT CARE:**

After removing the protective foil from the gloss fronts, the acrylic surface of the boards is still soft and easy to scratch. With air contact, the hygroscopic acrylic layer hardens, and the board becomes more resistant to scratches. It takes approximately 48 hours for the acrylic layer of the board to fully harden.

Replacement parts are shipped out in one business day. You will receive a tracking number via email once your parts request has been processed.

**DO NOT CLEAN, WIPE, OR POLISH THE
ACRYLIC FRONTS FOR 48 HOURS AFTER
REMOVING THE PROTECTIVE FOIL!!!**



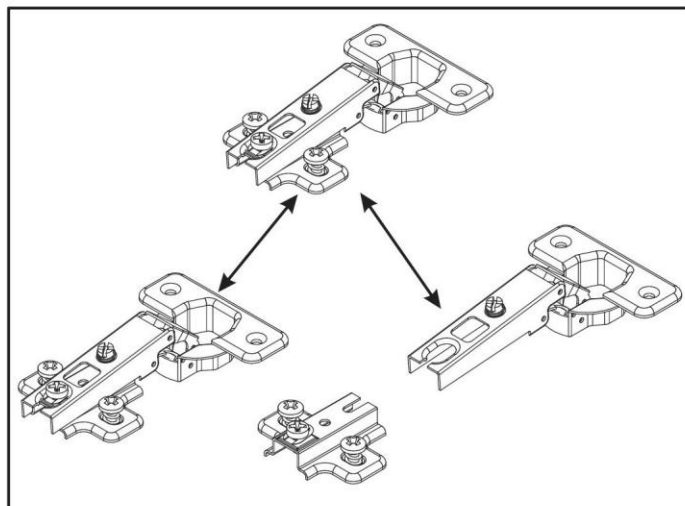
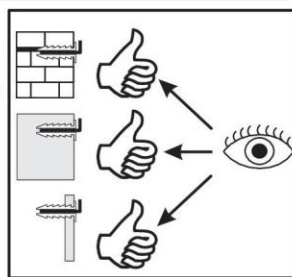
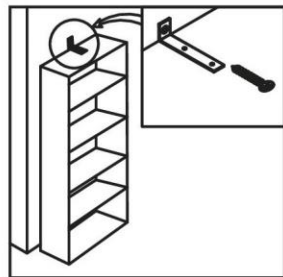
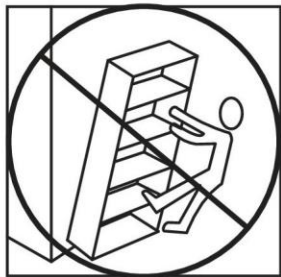
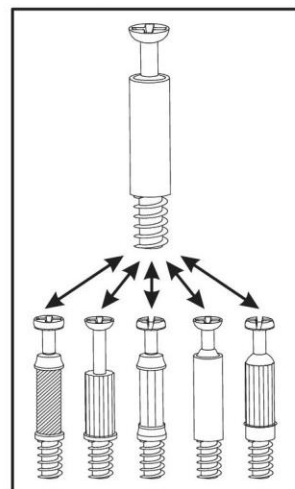
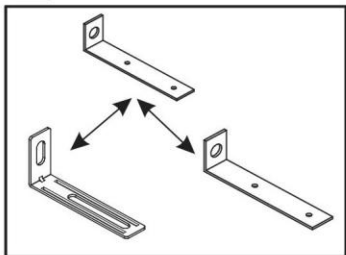
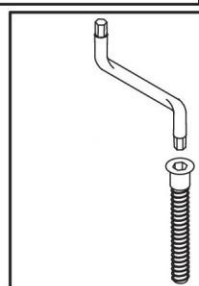
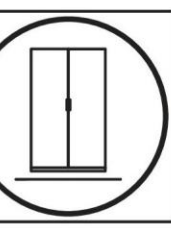
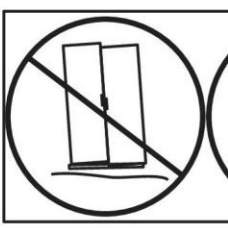
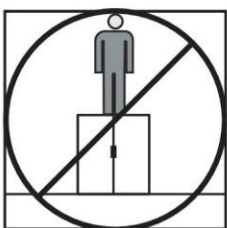
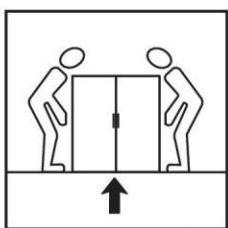
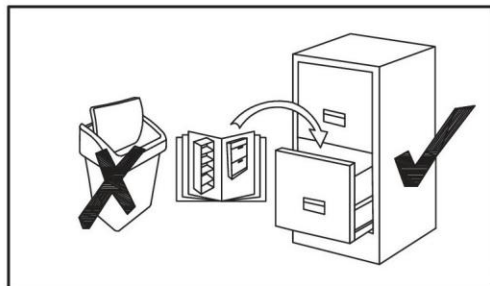
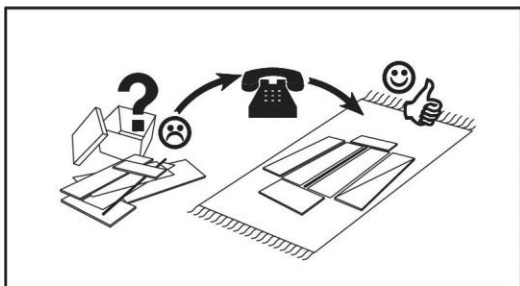
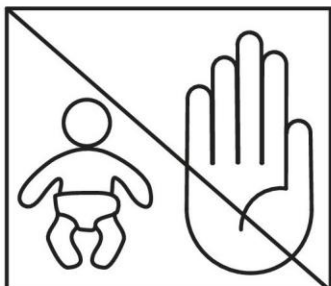
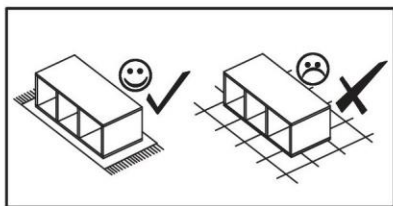
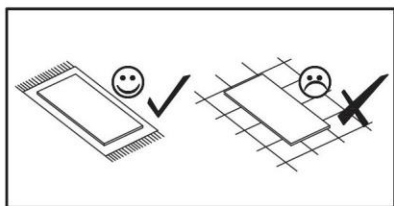

REPO COFFEE TABLE

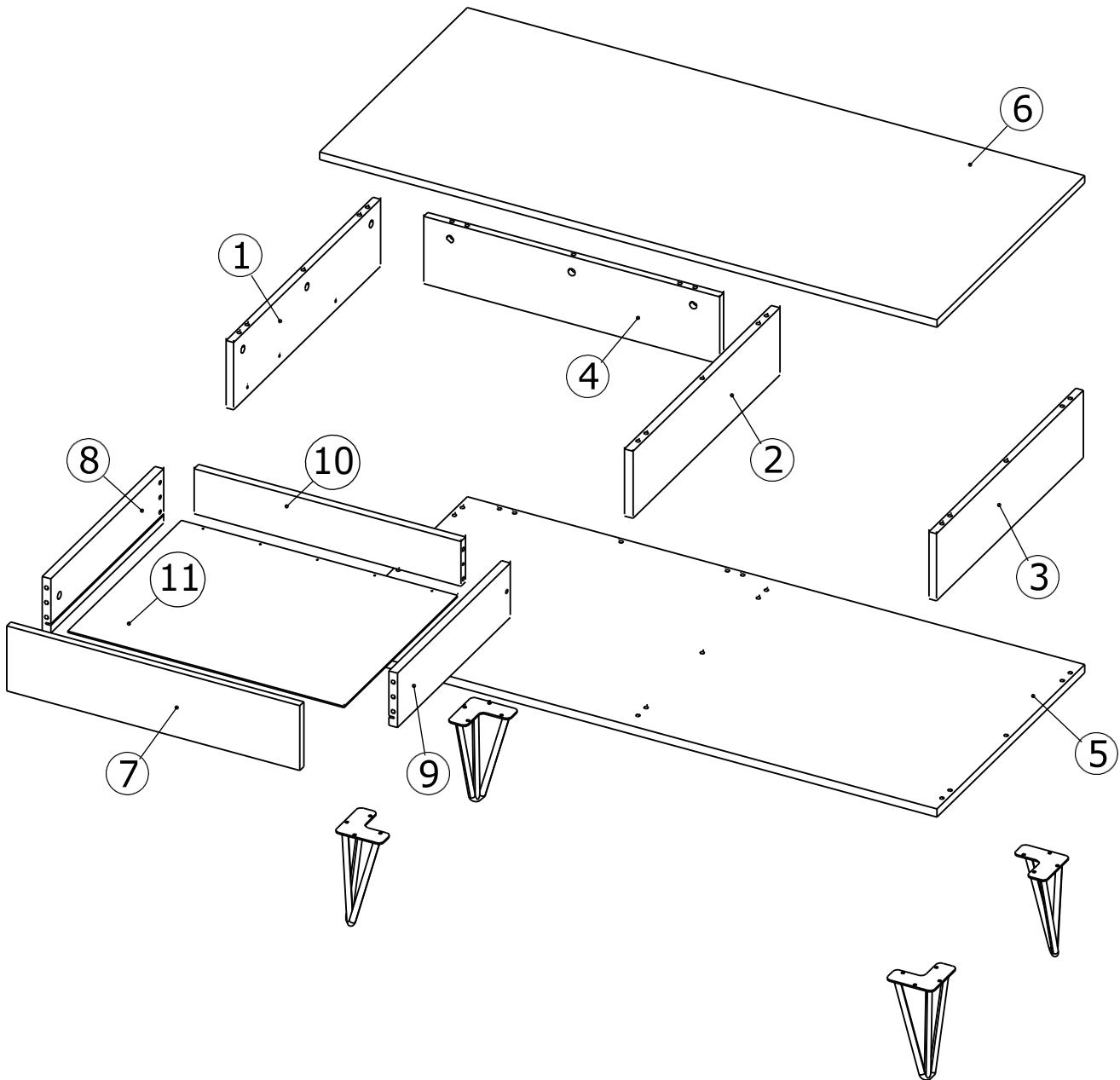
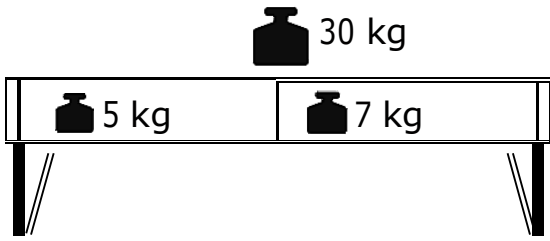

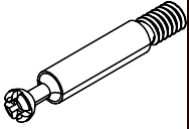
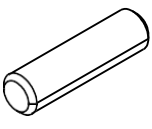
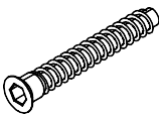
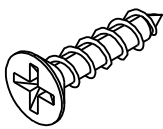
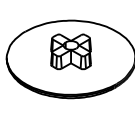
		8x30 	7x50 	2.5x16 	
A x 14	B x 14	C x 24	D x 14	E x 5	F x 5

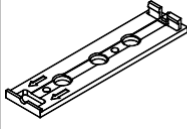
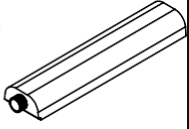
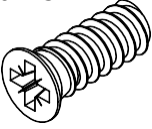
		6x13 			
G1 x 1	G2 x 1	G3 x 2			

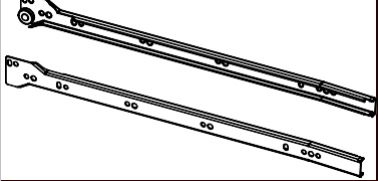
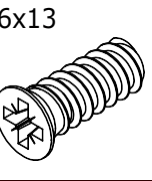
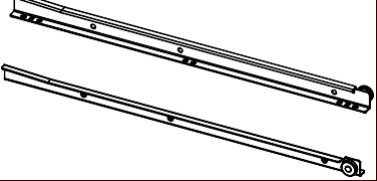
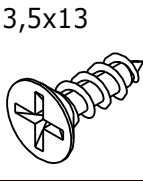

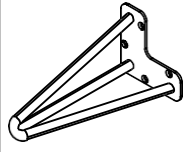
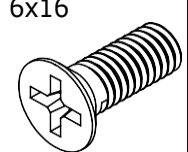
		6x13 			3,5x13 
H1/H2 x 1/1		H3 x 6	I1/I2 x 1/1		I3 x 6

	6x16 
J1 x 4	J2 x 16

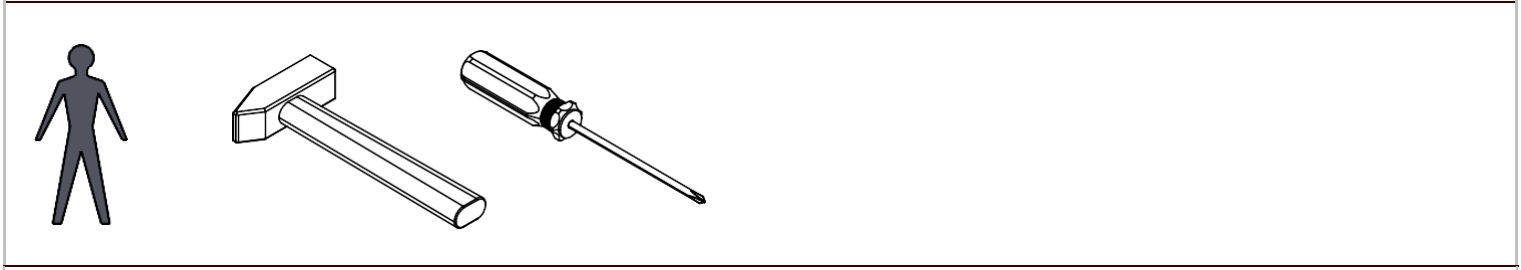
IMBUS

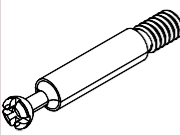
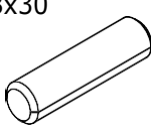
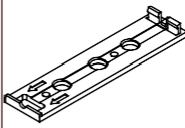

STEP - 1

				
Ax6	Bx12	Cx8	G1x1	G3x2

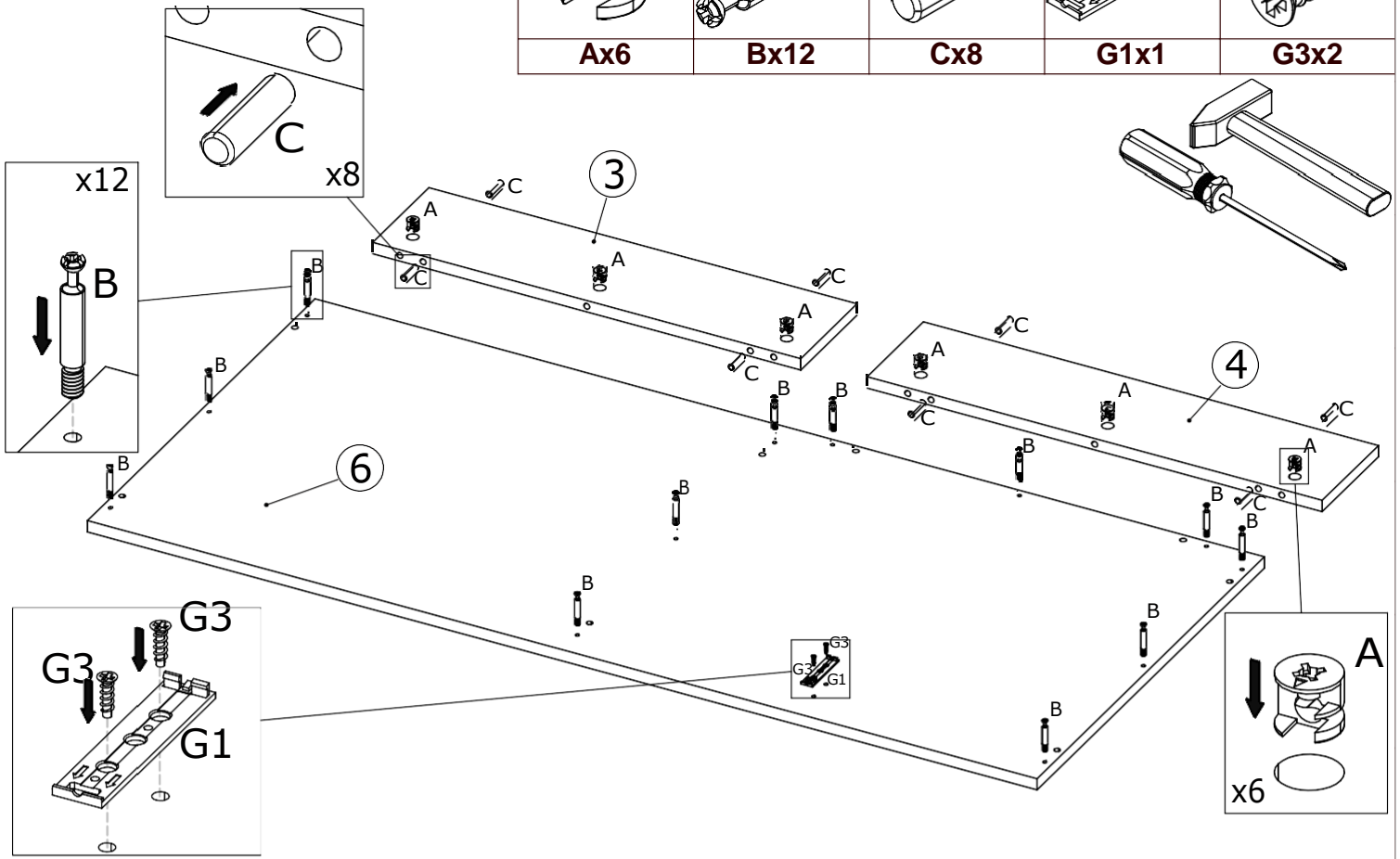

STEP - 2

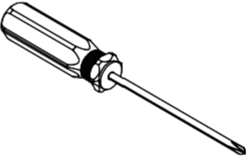
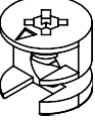
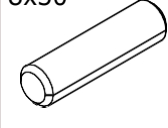
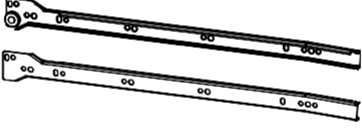
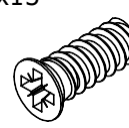
				
	Ax6	Bx8	H1/H2x1/1	H3x6

FRONT

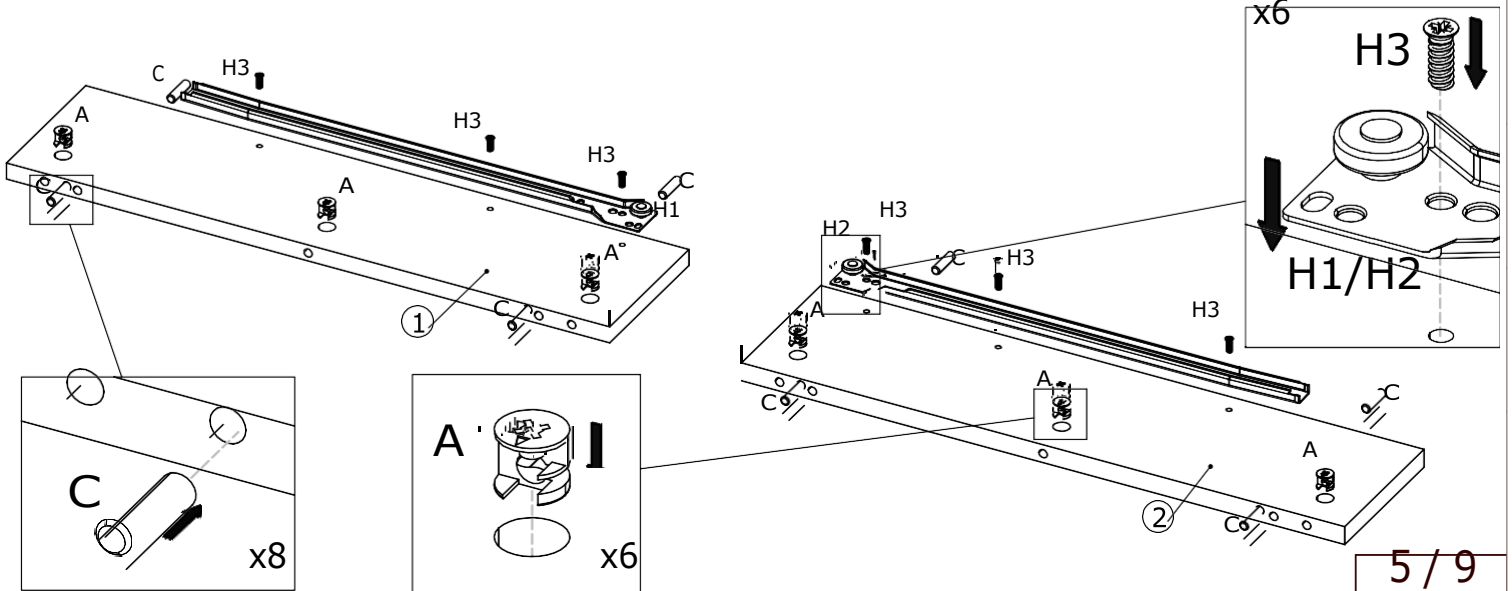
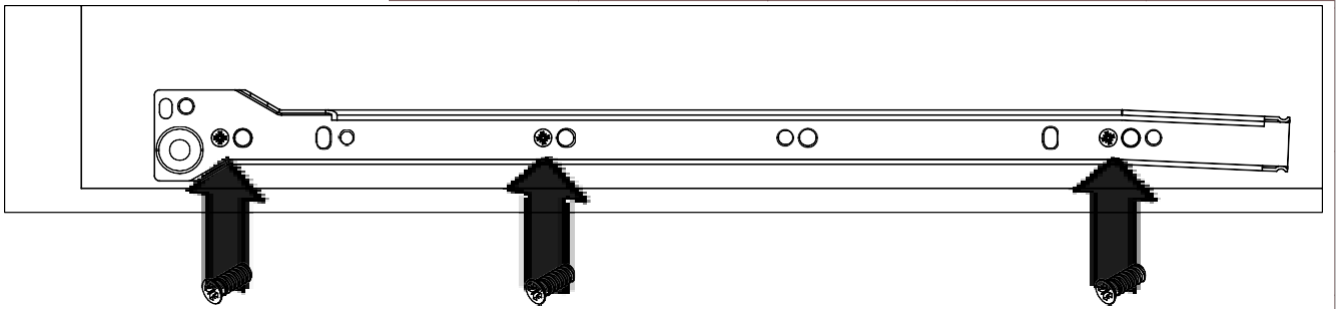

STEP - 3

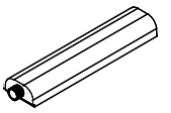
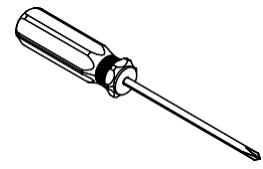
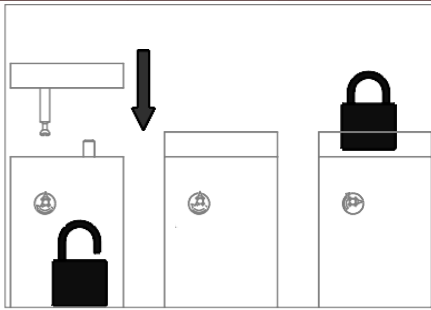

G2x1

x12

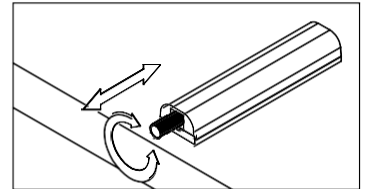
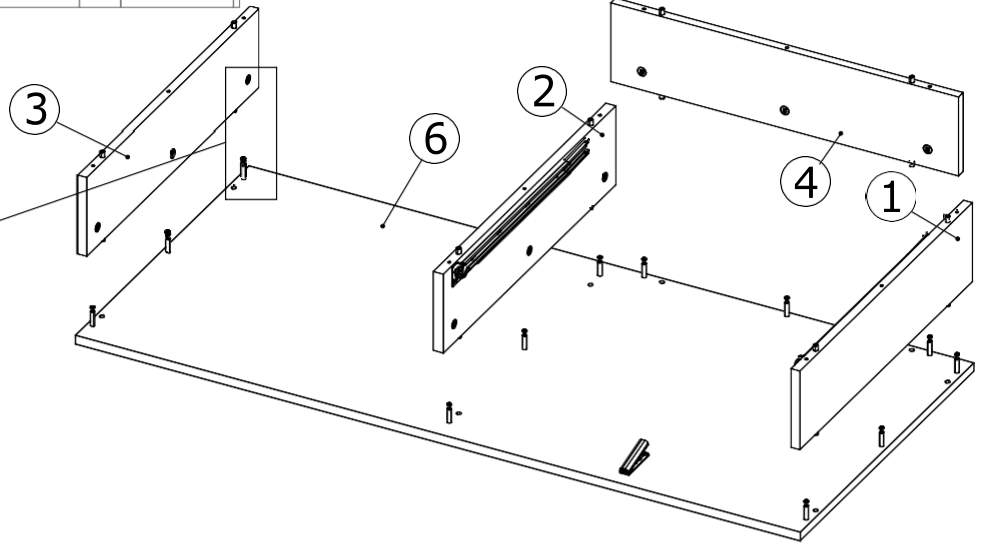
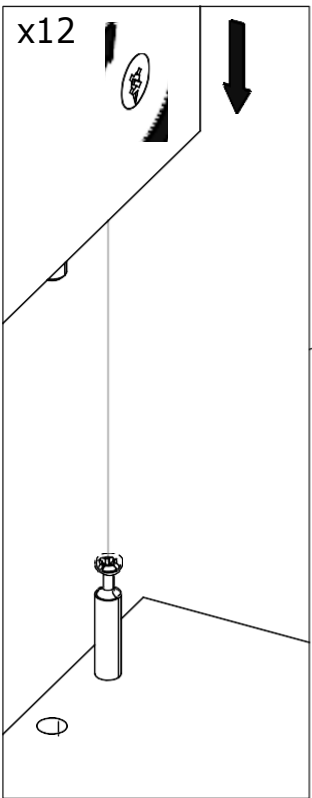

STEP - 4



7x50



Dx12

x12

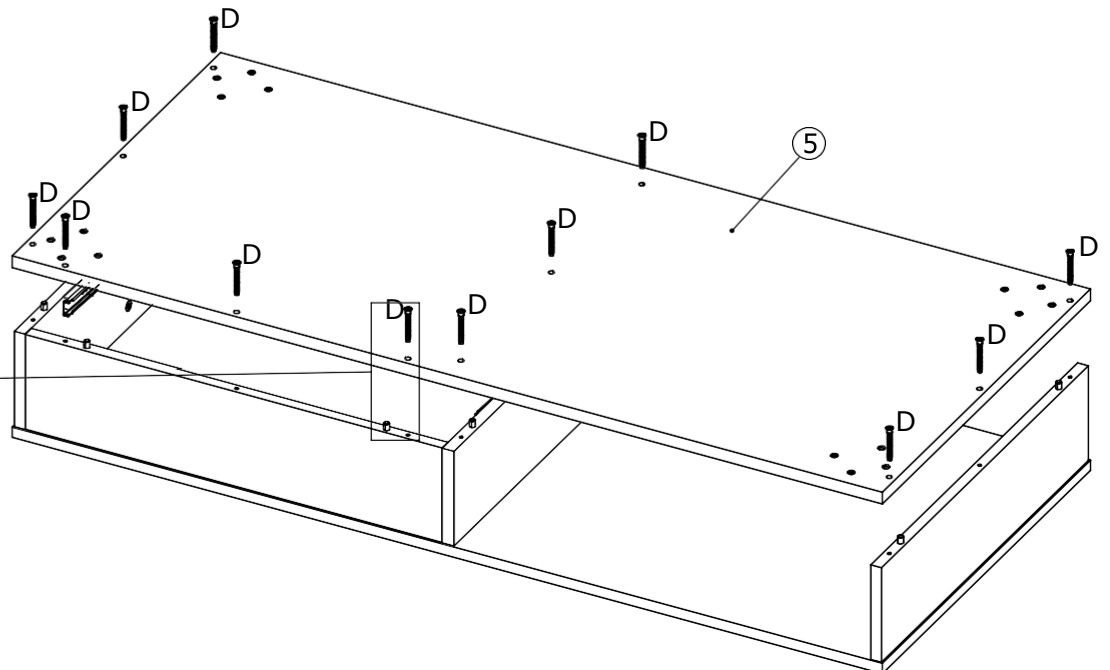
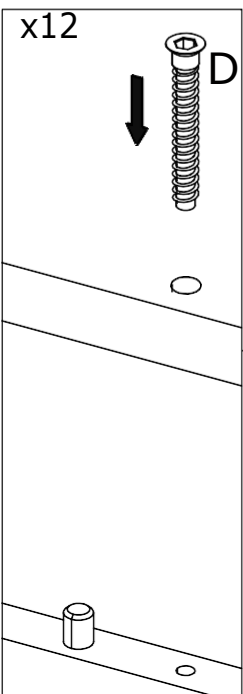

STEP - 5

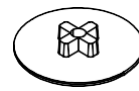
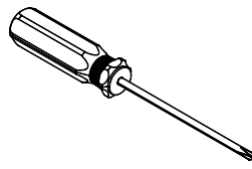

Fx3

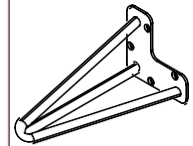

J1x4

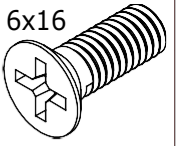

6x16

J2x16

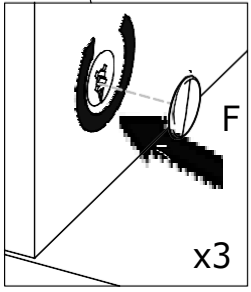
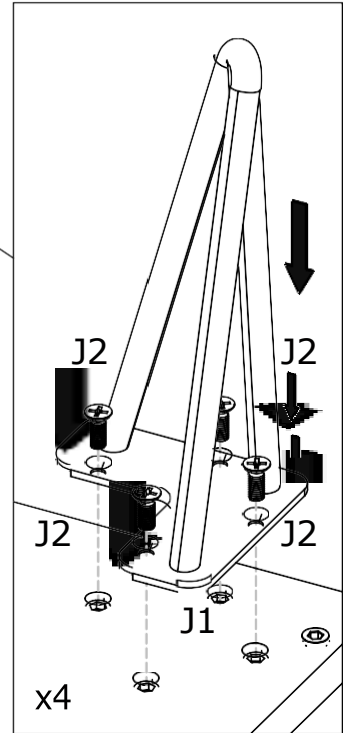
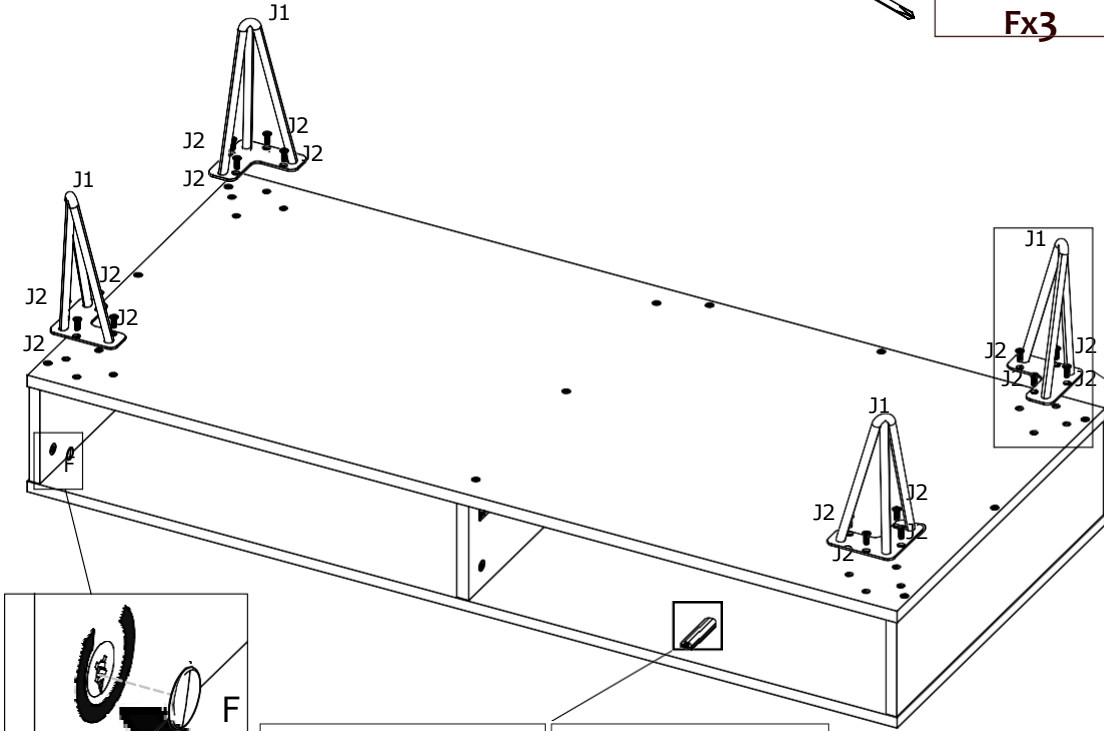

x3

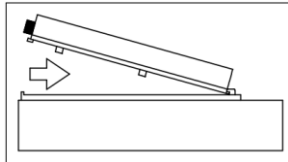

STEP - 6

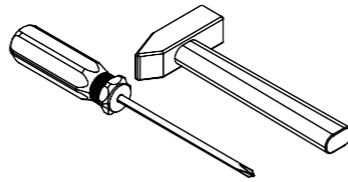

Ax2

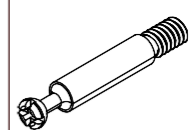

Bx2

8x30

Cx8

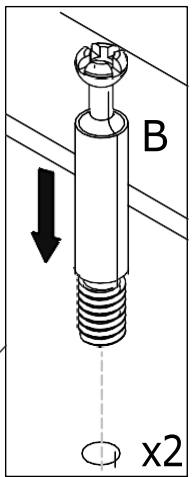
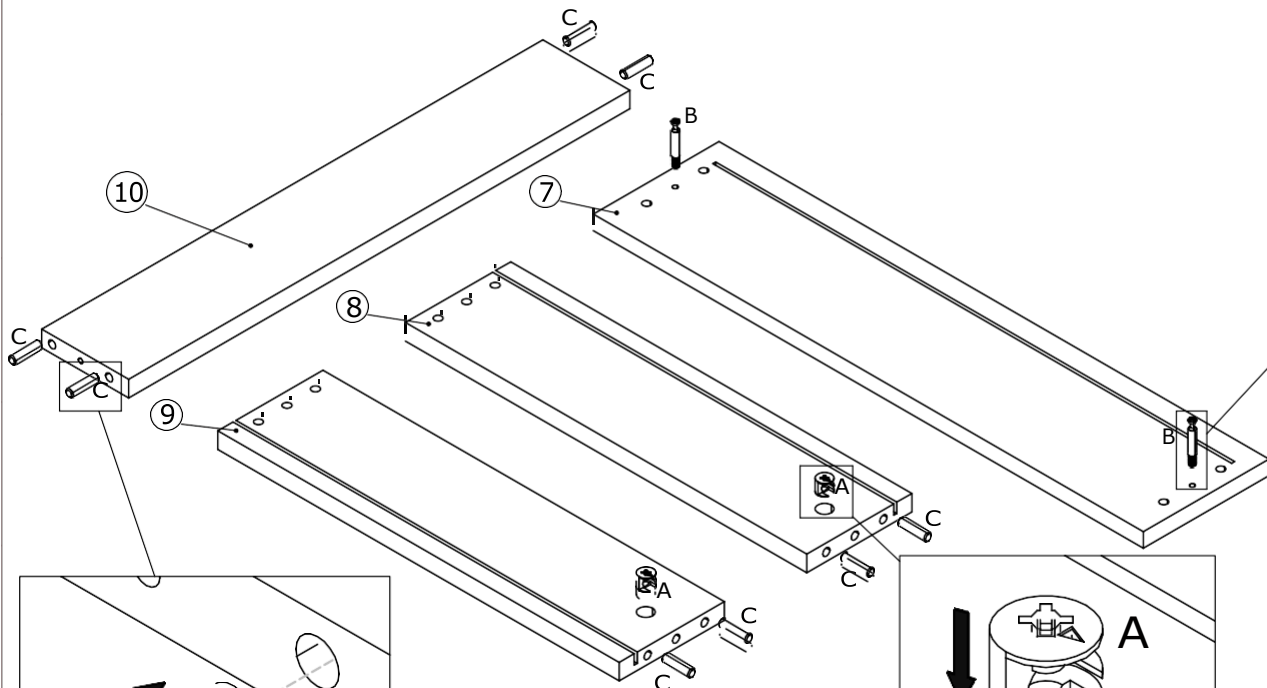

x2

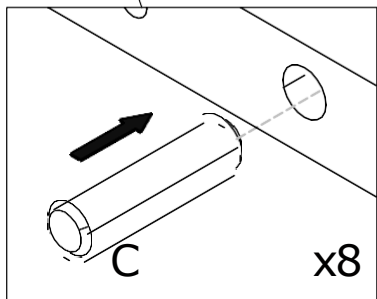

x8

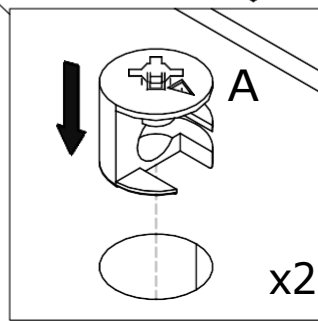

x2

STEP - 9

