

THANKS FOR WATCHING

Your feedback is invaluable to us and we would love to hear about your experience. Please take the time to leave us a review.

Installation Manual

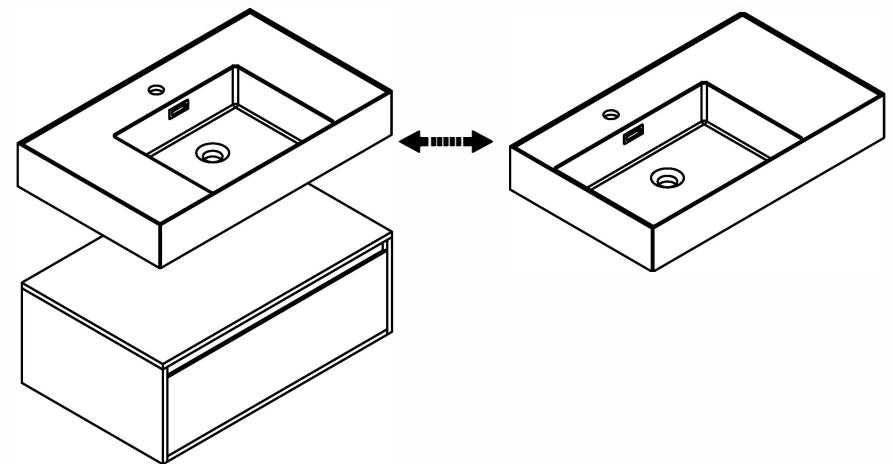





You can choose a 30 inch medium or left basin according to your own needs

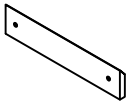

Thank you for shopping with us!

We encourage you to take a few minutes to go through this booklet. It contains important information on installation and care tips to keep your furniture looking as good as new.

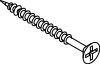
Hardware

NO.	Draw	QTY	NO.	Draw	QTY
A	 Plastic anchor(Ø12mm)	2	F		2
B	 Screws for fix on the wall with basin	2	G		4
C	 Plastic gasket	2	H		4
D	 Metal gasket	2			
E	 Metal nut	2			

Recommended tools

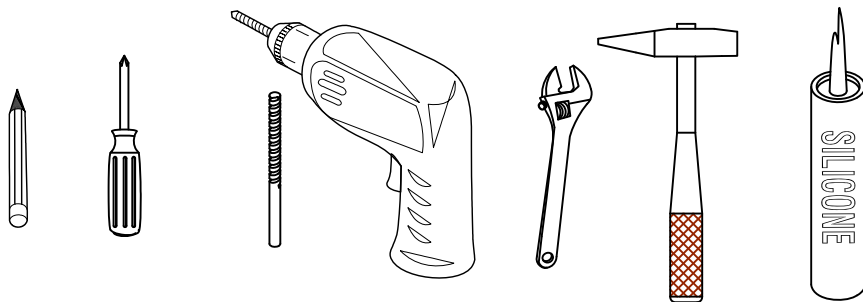

Dimensions

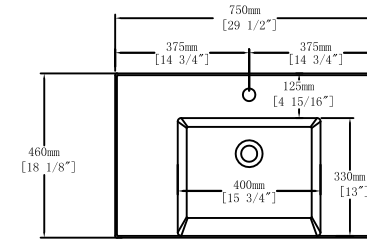

Top View

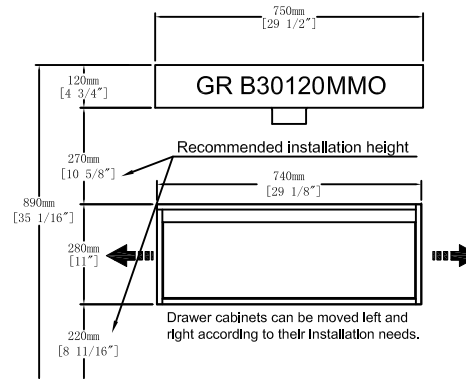

Front View

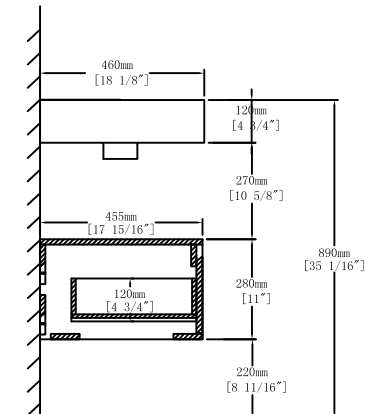

Side View

CARE CLEANING AND MAINTENANCE

1. Dust regularly with a soft, dry cloth.
2. Avoid the use of all chemicals household cleaners, abrasives, or cleaners that contain lemon, vinegar, or other acids that may damage the finish.
3. Excessive exposure to sunlight and extreme changes in temperature and moisture can damage wood furniture.
4. The sink is fragile, please pay attention to maintaining its appearance.
5. Do not place hot appliances, such as curling irons and hot hair dryers directly on the countertop. Wipe spills immediately.

Finished

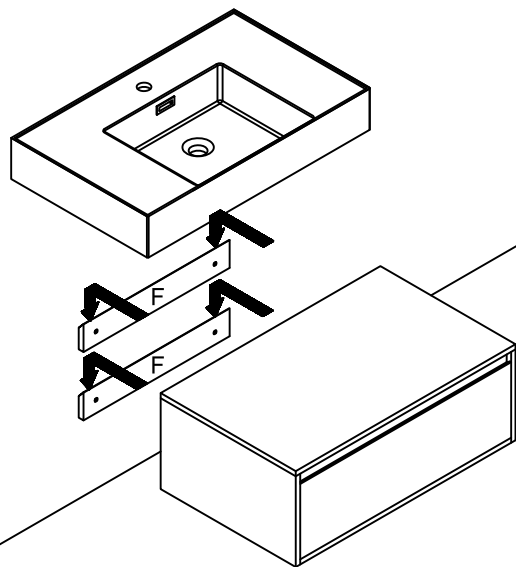

Step 1

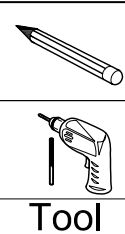
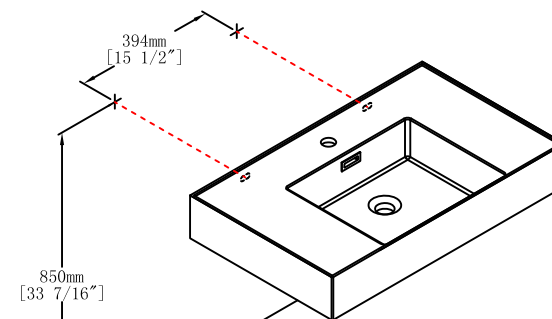

Tool

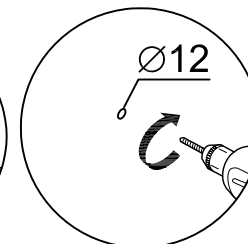
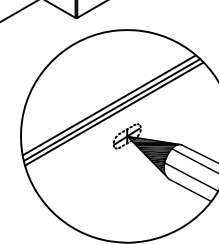

Dimensions

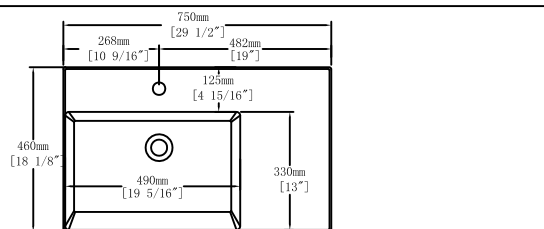

Top View

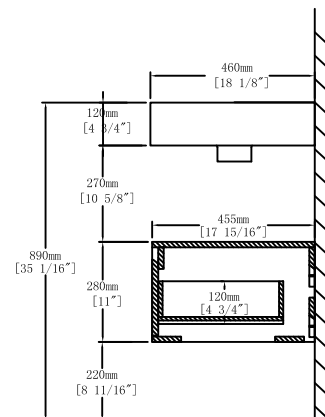

Side View

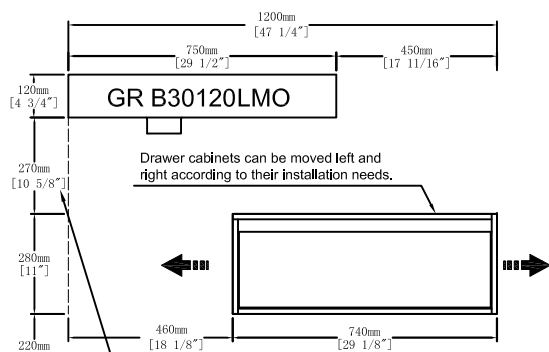

Front View

Recommended installation height

Step 2

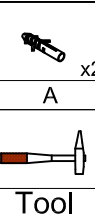
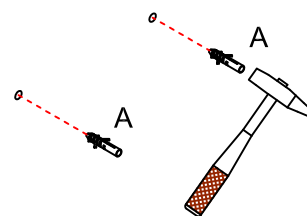

Tool

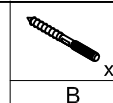
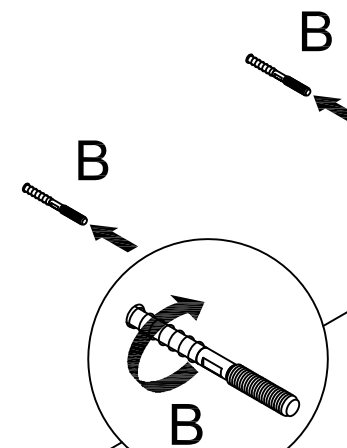

Step 3

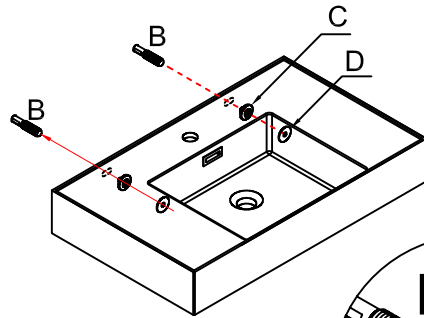

B

Step 4



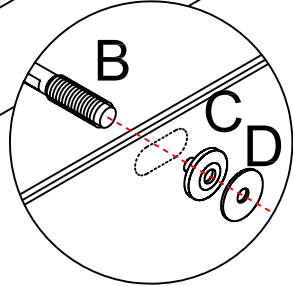

-  x2
- C
-  x2
- D

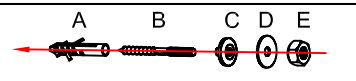

Place the basin in position against the wall, locating the fixing bolts through the holes in the rear of the basin. Push a plastic washer, followed by a metal washer, onto each fixing bolt.

Step 5



-  x2
- E
- 
- Tool

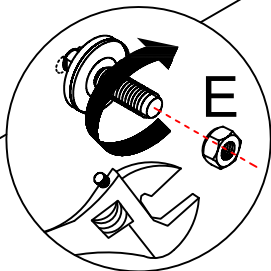

890mm
[35 1/16"]

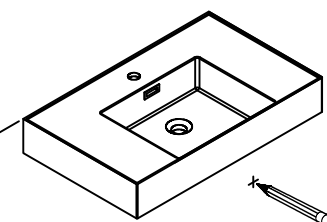

Screw a metal nut onto each fixing bolt to secure the basin. Caution: Do not overtighten, as this may damage the basin.

Step 6

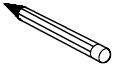

- 
- 
- Tool

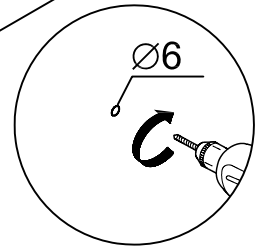

890mm
[35 1/16"]

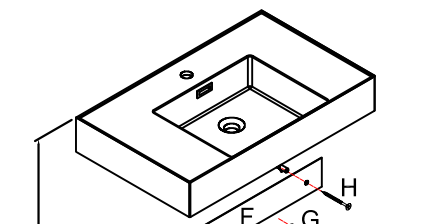

The installation height and left and right positions of the drawer cabinet can be positioned as needed.

Step 7

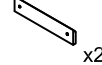

-  x2
- F
-  x4
- G
-  x4
- H

890mm
[35 1/16"]

