

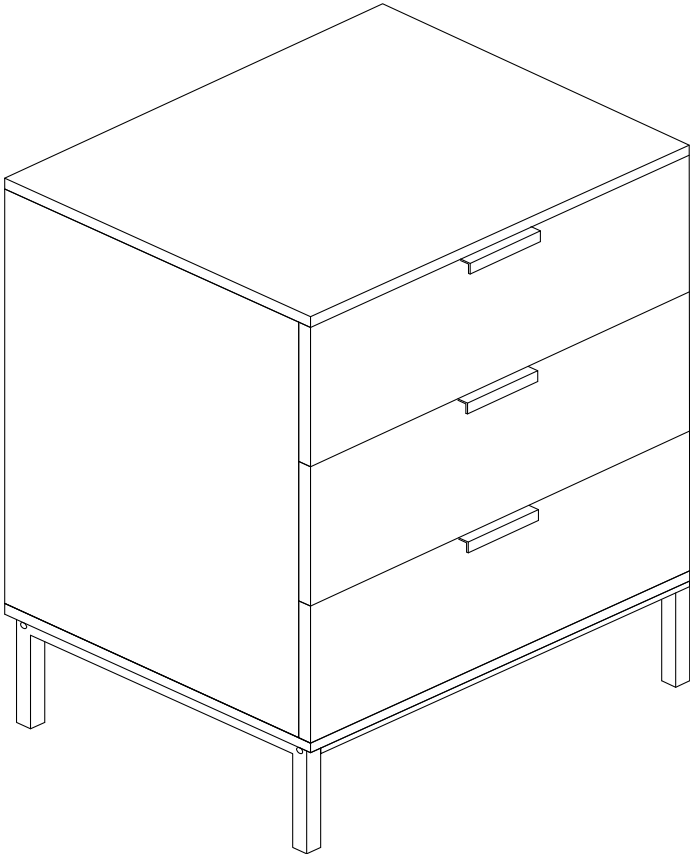

Herringbone 3 Drawer Nightstand

Applicable Item NO.: H0099



2 HOURS
ASSEMBLY TIME

1 PEOPLE
REQUIRED FOR ASSEMBLY

2 x 1 m
FLOOR SPACE REQUIRED

PLEASE READ ALL INSTRUCTIONS CAREFULLY BEFORE ASSEMBLING AND USING THE PRODUCT.

SAFETY ADVICE

- Keep the product away from fire and inflammable objects.
- Do not stand on the product or use the product as a stepladder.
- Do not overload, otherwise it will cause risk of injury and/or damage to the product.
- Never allow kids to climb on or lean against the product. The product comes with an anti-tip wall anchor. Do fix the anti-tip device to avoid potential injury.
- Check that the product is stably built before use and make sure the product stands on a solid and level surface.

CARE ADVICE

- Wipe with soft dry cloth.
- Never allow any sharp objects to touch the surface. It will damage the finish of the product.
- Never allow any kind of liquid to remain on the surface. Water penetration will cause damage to the wood material.
- Please periodically check all fittings and re-tighten as necessary.

ASSEMBLY ADVICE

- Ensure that you have sufficient space and people to assemble the product safely.
- Please check that all parts are present before you start the assembly. A Phillips head screwdriver (not included) is required for the assembly.
- Please assemble the product on a protected surface (packaging box, or mat, etc) to avoid any damage.
- During assembly, do not tighten bolts/screws completely until all bolts/screws are lined up and inserted into holes; do not over-tighten screws and bolts to avoid stripping; do not use power tools.
- Please check that the product is well and stably built before usage.

KEEP ALL SAFETY ADVICE AND SAVE THIS INSTRUCTIONS FOR FUTURE REFERENCE

Guarantee From Anmytek

We offer 12-month warranty for all our products from the date of original purchase.

Statement:

The product is well-packed with strengthened box and protective foam. Each panel is separately wrapped with soft protective foam, while the hardware is included in a single box. An instructions manual should be included in the box as well. Well protected though, damage happens sometimes.







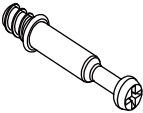

To successfully assemble the item and enjoy your cozy furniture, please kindly check the parts and accessories according to the packing list in the next two pages.

If there are any parts missing, damaged or defective, please feel free to contact us for support via the following email. You can contact us for support at any time. Usually we will respond to you within 24 hours.

Email: service@anmytek.com

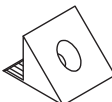
The information required for a better support from us:
Order Number:
Part Number needed to replace:
Shipping Information (Name, Address, Contact Number):
Picture of the damaged/defective parts (If possible):

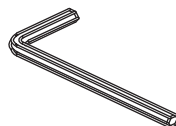
Note: If the instructions manual is missing pages, there is a QR Code printed on the packaging box where you can scan and download the electrical instructions for reference. If error happens, contact us via email directly.

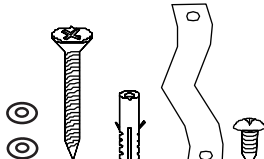
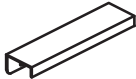
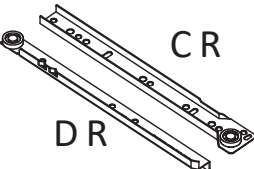
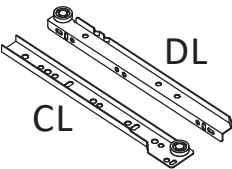
Hardware List			
 $\Phi 6 \times 35 \text{mm}$ A×20	 $\Phi 15 \times 9 \text{mm}$ B×20	 $\Phi 6 \times 30 \text{mm}$ C×8	 $\Phi 4 \times 40 \text{mm}$ D×16
 $\Phi 3 \times 12 \text{mm}$ E×30	 F×8	 $\Phi 3 \times 14 \text{mm}$ G×8	 $\Phi 6 \times 40 \text{mm}$ H×4
 I×1	 $\Phi 4 \times 30 \text{mm}$ J×8	 K×1	 L×3
 T (CR DR) ×3	 T (CL DL) ×3		

Product Diagram

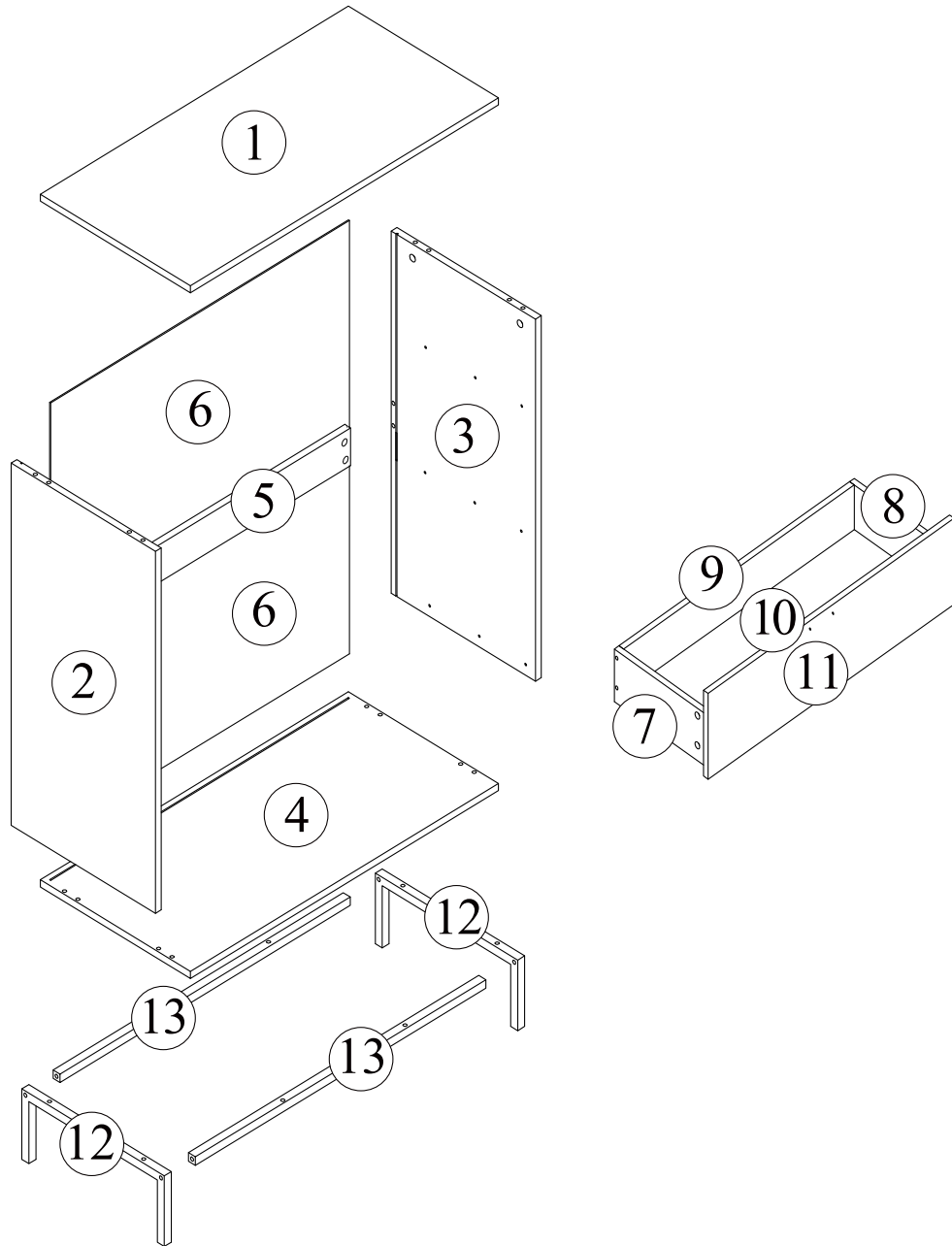





After-sales Support

If there are any parts missing, damaged or defective, please feel free to contact us for support via the following email. Information required is listed on Page 3.

Email: service@anmytek.com

Step 1

- A × 8

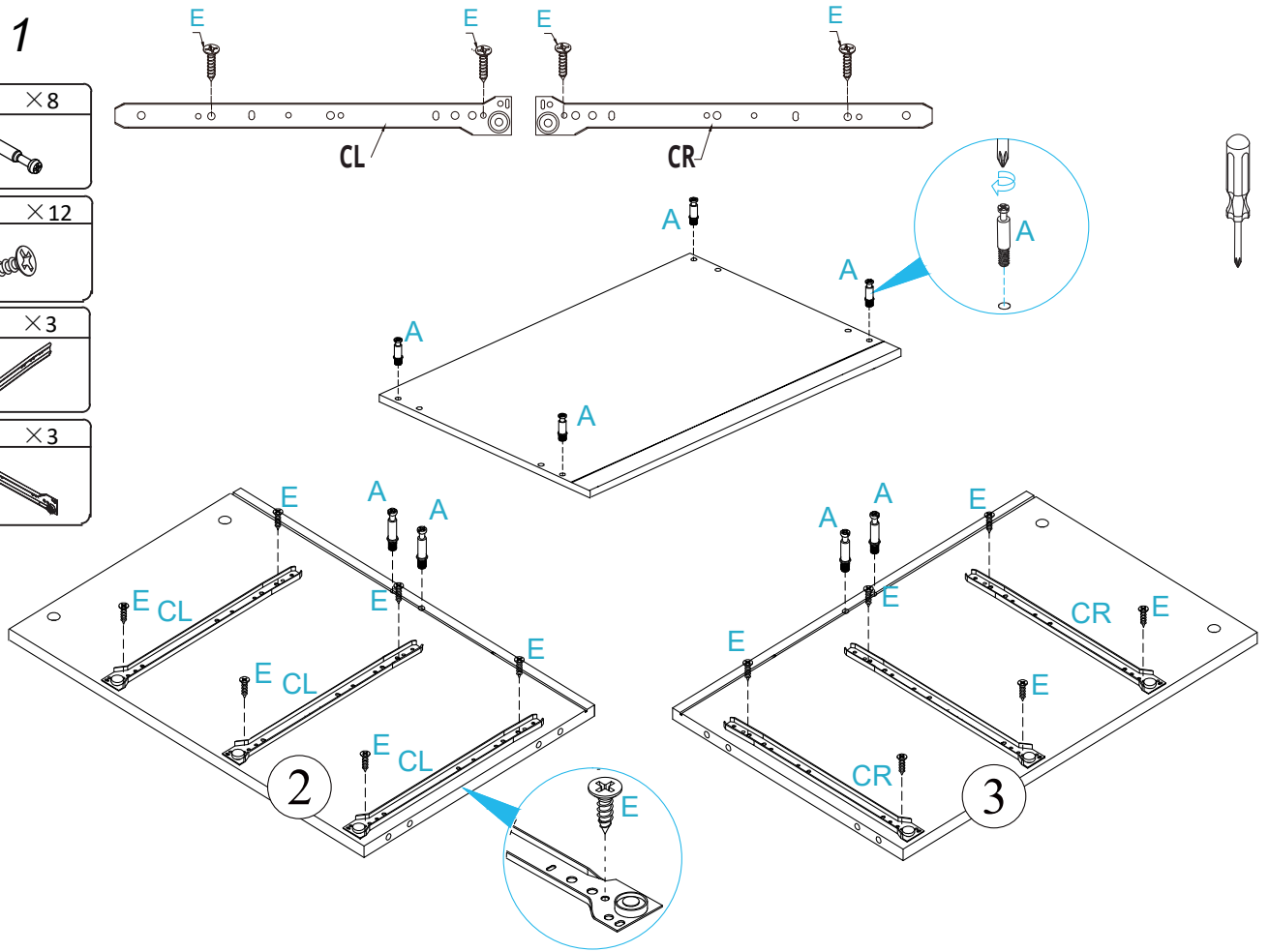
- E × 12

- CL × 3

- CR × 3

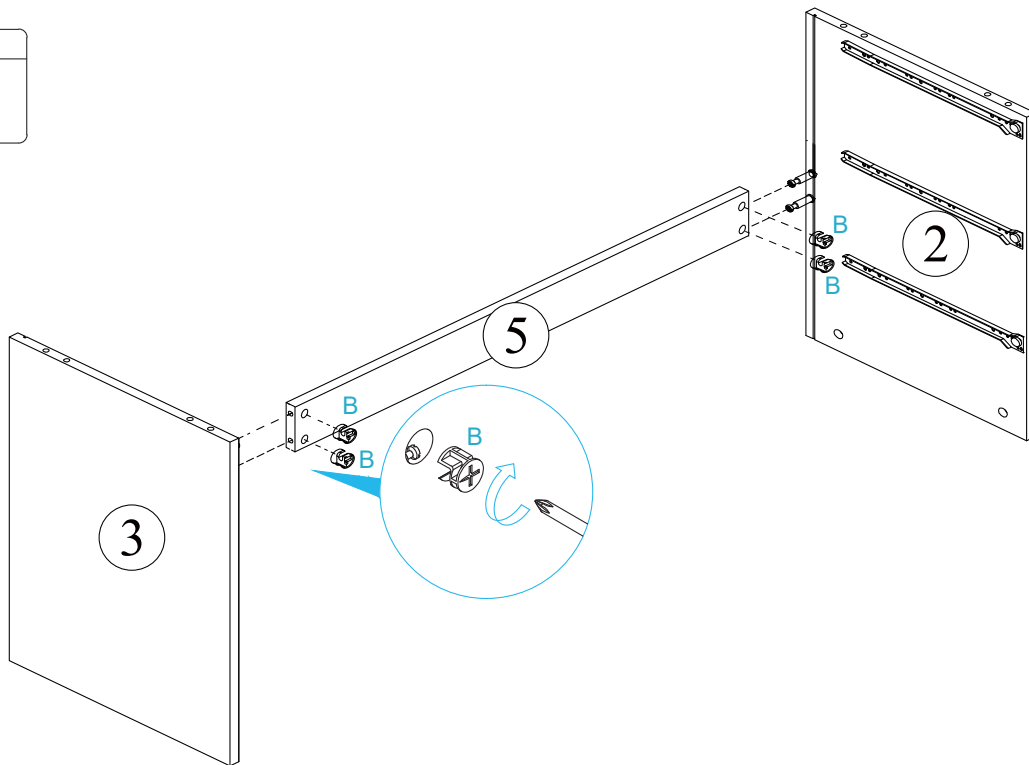

Step 2

- B × 4



Step 3

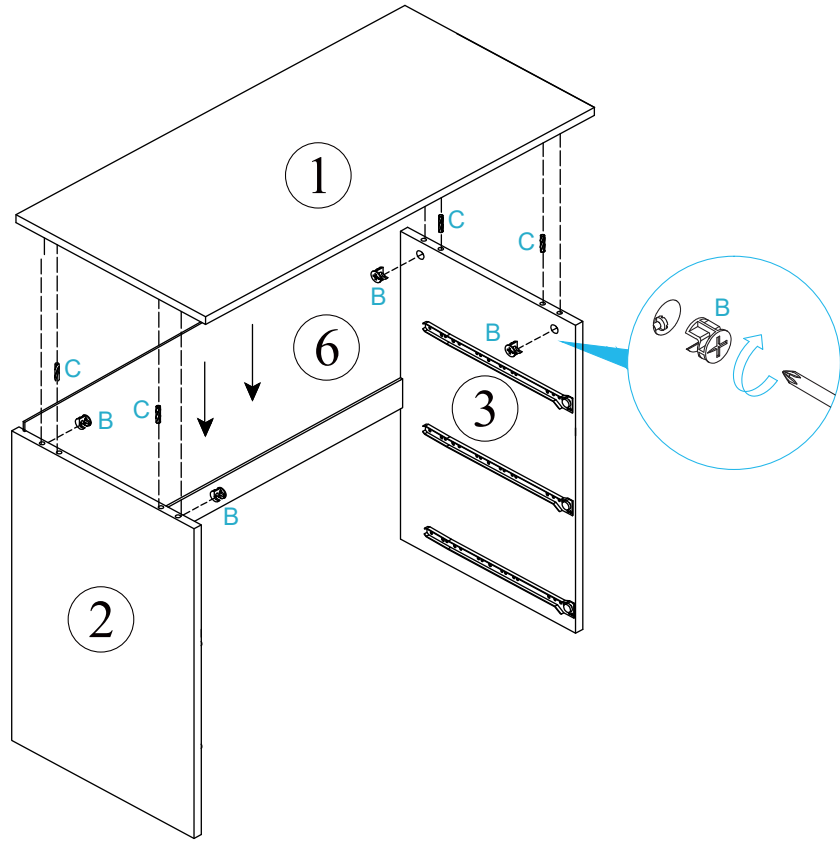
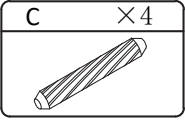
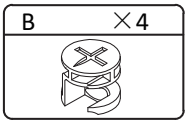

Step 4

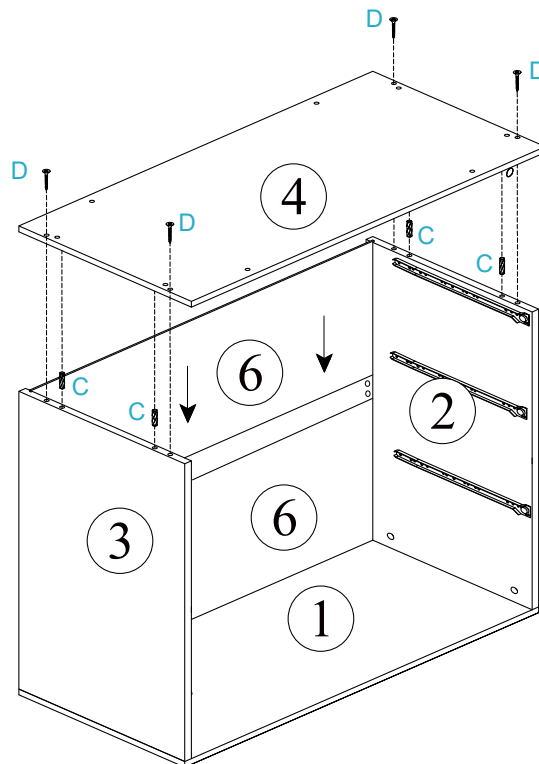
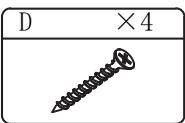
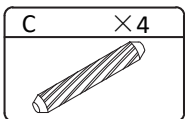

Step 5

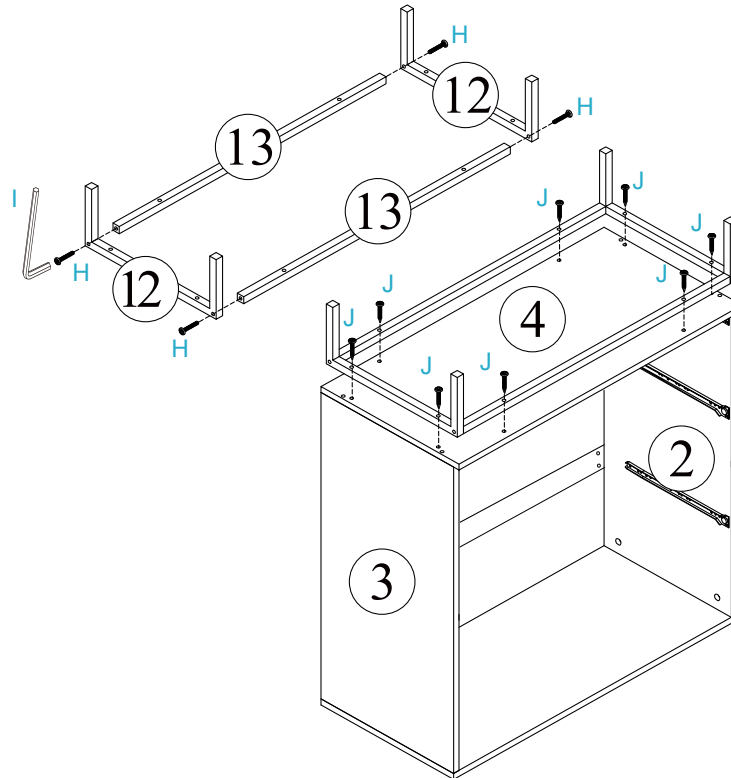
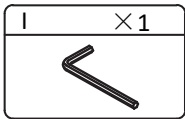
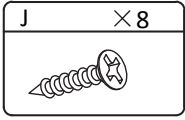
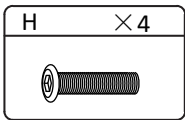

Step 6

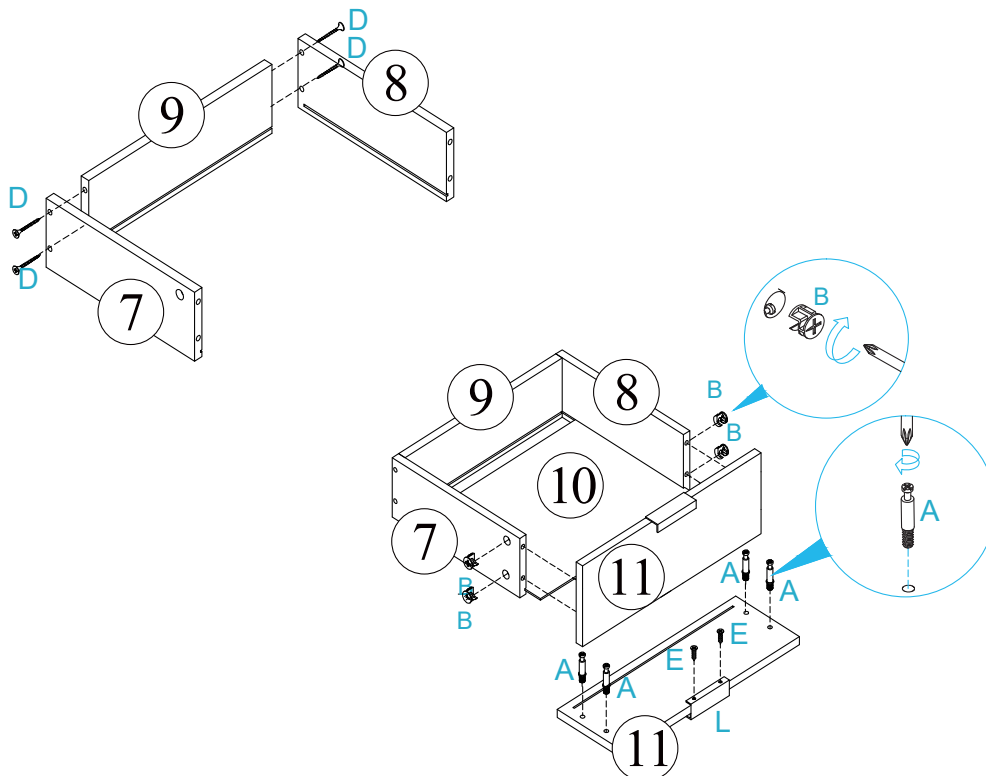
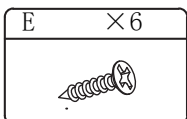
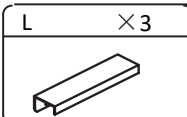
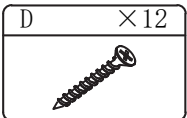
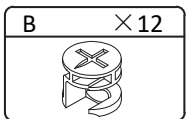
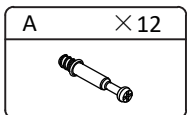

x3

Step 7

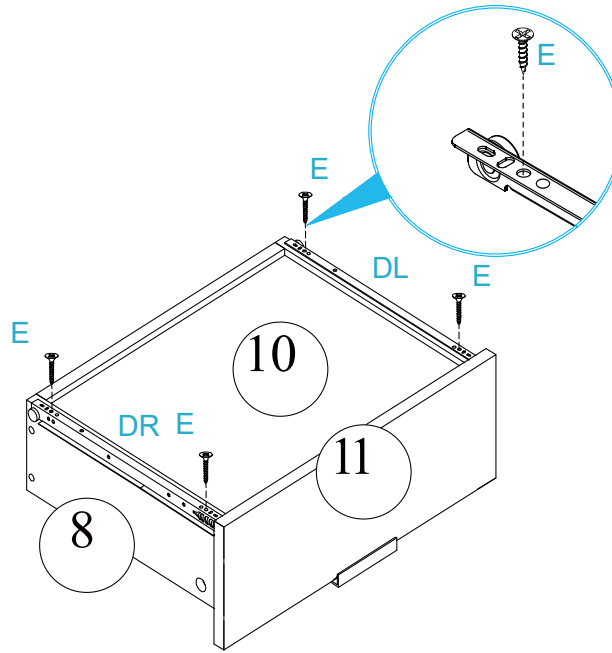
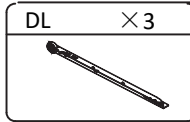
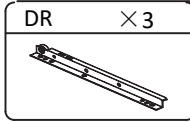
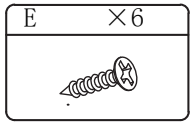

x3

Step 8

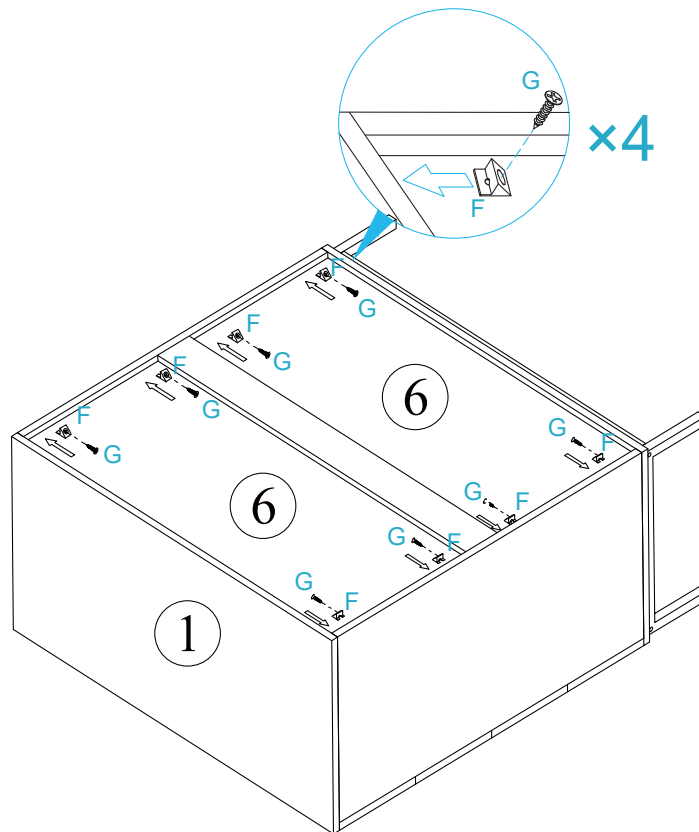
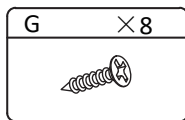
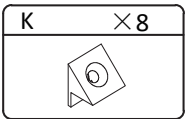

Kindly note: This is a very important step that can not be skipped. Please follow the step to screw the plastic pieces into the corner of the back panel tightly. If you forget to fix these pieces, it may result in the instability of the whole item.

Step 9

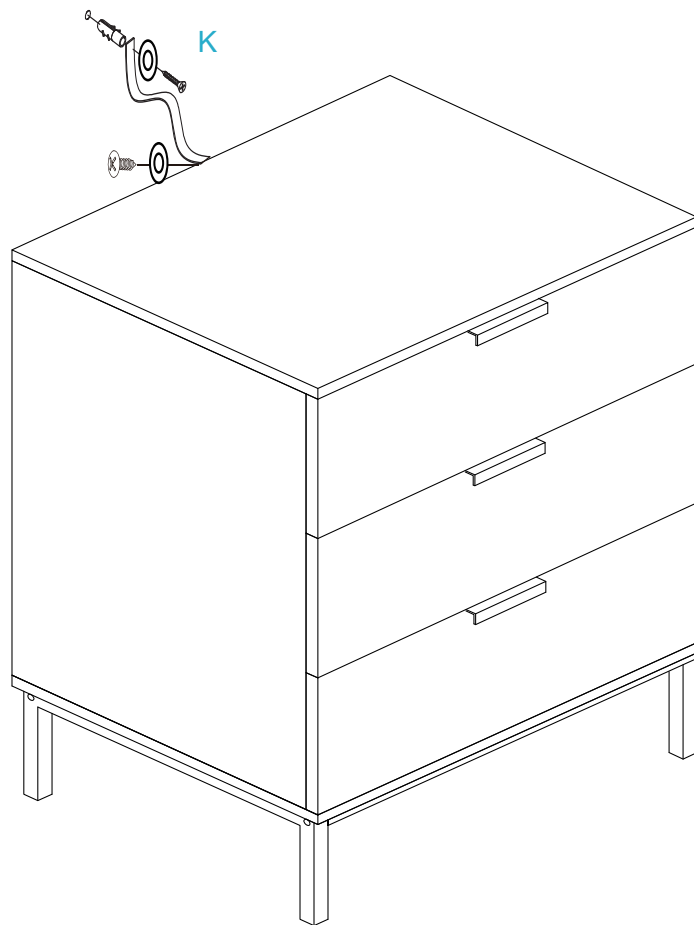
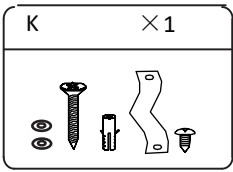

WALL FIXING GUIDE

NOTE: Supplied wall plugs are only suitable for use in masonry walls.

If you have any doubts about using the correct plug for your wall, please seek professional advice. Failure of the product due to using incorrect fixings is the responsibility of the installer.



IMPORTANT:

When drilling into walls, always check for hidden wires or pipes, etc.



Tips & Tricks

Make sure that the hardware used is suitable for supporting your unit.

Please consult a qualified trades person if unsure.

- ☑ If you are unsure, please select a larger screw and wall plug.
- ☑ Ensure that you use the recommended drill bit to match the wall plug and hole size.
- ☑ Take extra care when drilling high walls, ceiling and ceramic tiles. Ensure wall plugs are inserted beyond the thickness of the ceramic tiles to avoid splitting or cracking.
- ☑ Ensure that wall plugs are well fitted and are a tight fit in the drilled hole.

Types of Walls

Use one of the following types of wall plug (not included) if your walls are made of brick, breeze block, concrete, stone or wood. Screws may be able to be fixed directly to solid wood walls as they will provide a secure anchor point.

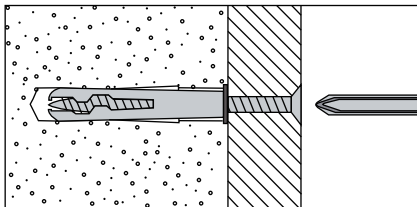

1. General Purpose Wall Plug

Generally, aerated blocks should not be used to support heavy loads, use a specialist fitting in this case. For light loads, general purpose wall plugs can be used.

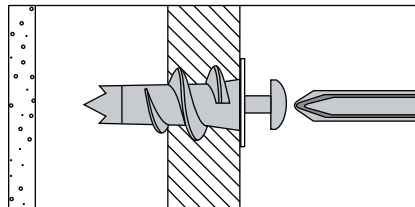

2. Plasterboard Wall Plug

For use when attaching light loads onto plasterboard partitions.

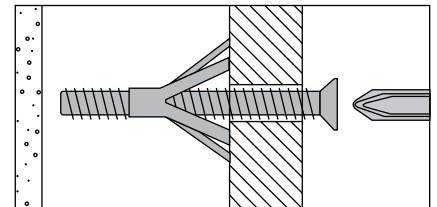

3. Cavity Fixing Wall Plug

For use with plasterboard partitions or hollow wooden doors.

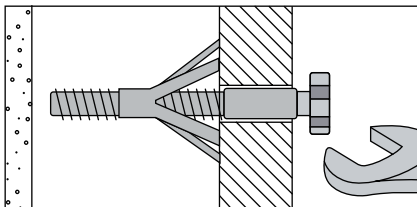

4. Cavity Fixing Heavy Duty Wall Plug

For use when fitting or supporting heavy loads such as shelving and wall cabinets.

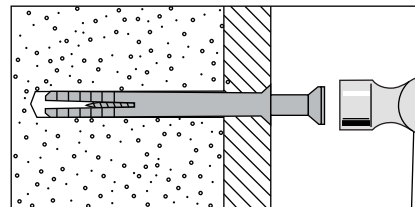

5. Hammer Fixing Wall Plug

For use with concrete block or brick walls, or walls stuck with plasterboard. The hammer fixing allows it to be fixed to the wall rather than the plasterboard. Always check the fixing is secure to the retaining wall.

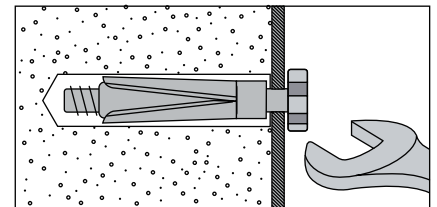

6. Shield Anchor Wall Plug Heavy Loads

For use with concrete or brick walls, or for use with heavier loads such as TV & HiFi speakers and satellite dishes, etc.