

IMPORTANT PLEASE FOLLOW !

After unpacking the product, keep the original packaging in case you need to return it. Before starting assembly, check that all parts and hardware are included and in good condition. If anything is missing or damaged, contact the supplier or retailer. **Do not use** non-original parts, modify the item or use power tools as this will void the warranty. Study the instructions thoroughly and follow each step carefully before proceeding to the next.

TESSA 3 DRAWER BEDSIDE NATURAL OAK EFFECT ASSEMBLY INSTRUCTIONS



20KG
MAX
WEIGHT



7KG
MAX DRAWER
WEIGHT

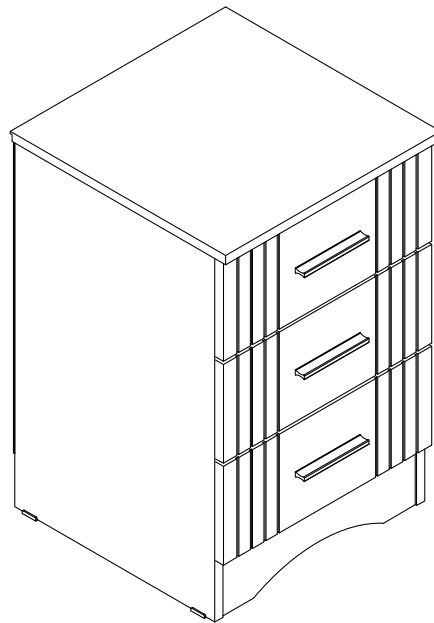

FOR DOMESTIC USE ONLY FURNITURE CARE AND MAINTENANCE PLEASE READ BEFORE YOU CONTINUE FURTHER

Safety

- Keep children away from the area during assembly for safety.
- Use a blanket or sheet on the floor during assembly to protect both the product and your flooring.
- Attach the Anti-Tip strap shown on the final step to the wall. This will prevent the item from tipping over and causing damage or serious injury.
- Follow all recommended weight limits as shown on the assembly instructions.

Care

- Avoid dragging or pushing the product, as this may damage the joints and weaken the structure.
- Avoid prolonged exposure to direct sunlight, which can cause fading, discolouration, or drying of natural wood.
- Maintain stable room temperature and humidity, as extreme heat, cold, or moisture may lead to warping, cracking, or swelling.
- Protect the surface from hot or cold items by using placemat's or coasters.
- Please avoid attaching anything sticky to the item, such as Sellotape, stickers, or similar materials, as this can damage the finish.
- Use felt pads under décor, lamps and accessories to prevent scratches.
- Clean spills immediately, blotting rather than rubbing to prevent spreading and surface damage.

Maintenance



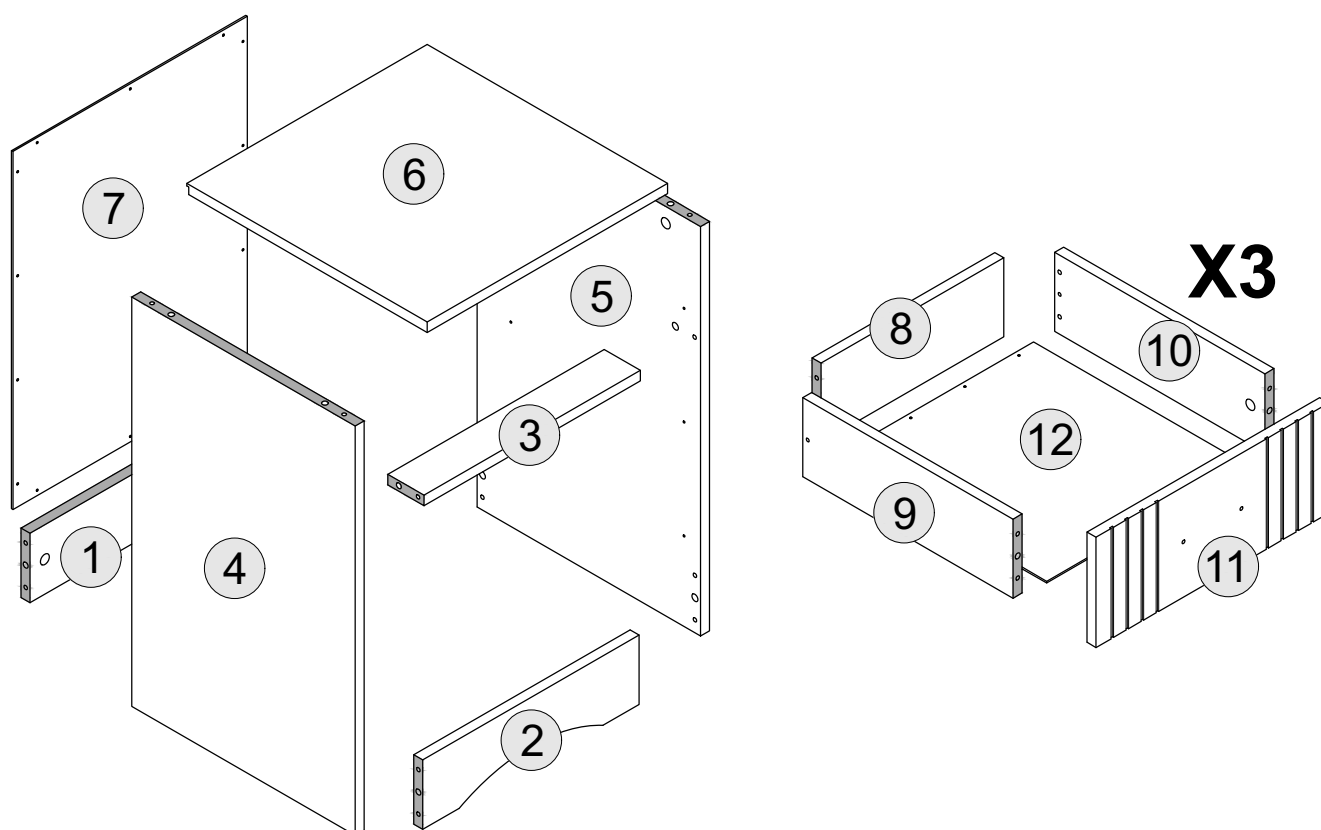





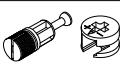

- Periodically tighten all fittings to ensure the furniture remains stable and secure.
- Use only a damp cloth followed by a dry cloth for routine cleaning - avoid detergents, solvents and chemical cleaner.

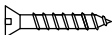

PART LIST

Part Number	Part Code	Part Description	Quantity	Carton
1	S100-103-127-EU1-01	Back Plinth	1	1/1
2	S100-103-127-EU1-02	Front Plinth	1	1/1
3	S100-103-127-EU1-03	Front Crossbar	1	1/1
4	S100-103-127-EU1-04	Side Panel - Left	1	1/1
5	S100-103-127-EU1-05	Side Panel - Right	1	1/1
6	S100-103-127-EU1-06	Top Panel	1	1/1
7	S100-103-127-EU1-07	Back Panel	1	1/1
8	S100-103-127-EU1-08	Drawer Back	3	1/1
9	S100-103-127-EU1-09	Drawer Side - Left	3	1/1
10	S100-103-127-EU1-10	Drawer Side - Right	3	1/1
11	S100-103-127-EU1-11	Drawer Front	3	1/1
12	S100-103-127-EU1-12	Drawer Base	3	1/1

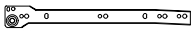
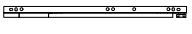
HARDWARE LIST

A		DOWEL 6 X 30MM	38 PCS
B		CAM BOLT + CAM NUT	16 SETS
C		PLASTIC FOOT	4 PCS
D		SCREW M3.5 X 16MM	22 PCS
E		TACK	23 PCS
F		SCREW M4 X 25MM	6 PCS
G		HANDLE	3 PCS
H		SCREW M3.5 X 12MM	27 PCS
I		SCREW M4 X 38MM	6 PCS
J		DRAWER RUNNER A - L/R	6 PCS
K		DRAWER RUNNER B - L/R	6 PCS
L		ANTI - TIP STRAP	2 PCS
M		SCREW M4 X 16MM	2 PCS

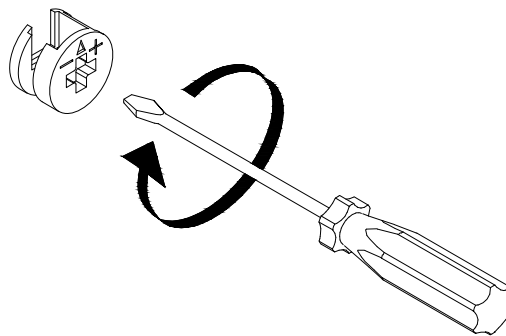

(SCREWDRIVER NOT PROVIDED)

USE A FLAT HEAD SCREWDRIVER TO TIGHTEN THE CAM NUTS. A QUARTER TURN CLOCKWISE IS ALL THAT IS NEEDED.

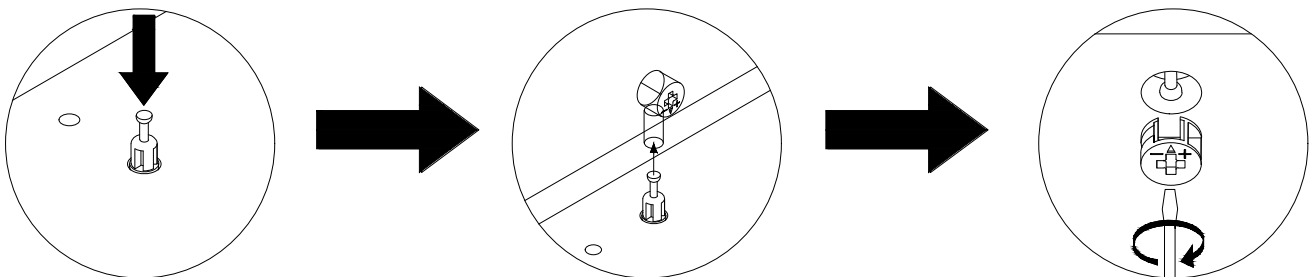

STEP 1 - PUSH CAM BOLT INTO INSERT

STEP 2 - ALIGN THE CAM BOLT WITH THE HOLE AND PUSH TOGETHER UNTIL FLUSH. (MAKE SURE THE ARROW OF THE CAM LOCK IS POINTING TOWARD ON THE EDGE OF THE PANEL.)



STEP 3 - THE HEAD OF THE BOLT GOES INTO THE WIDE MOUTH OF THE CAM LOCK. YOU THEN TURN THE LOCK SO THE NARROW PART CLOSES OVER THE BOLT.

STEP 1

PARTS REQUIRED

1 - BACK PLINTH	x1
2 - FRONT PLINTH	x1
3 - FRONT CROSSBAR	x1
6 - TOP PANEL	x1

HARDWARE REQUIRED

A		10
B		04
B		06

TOOLS REQUIRED

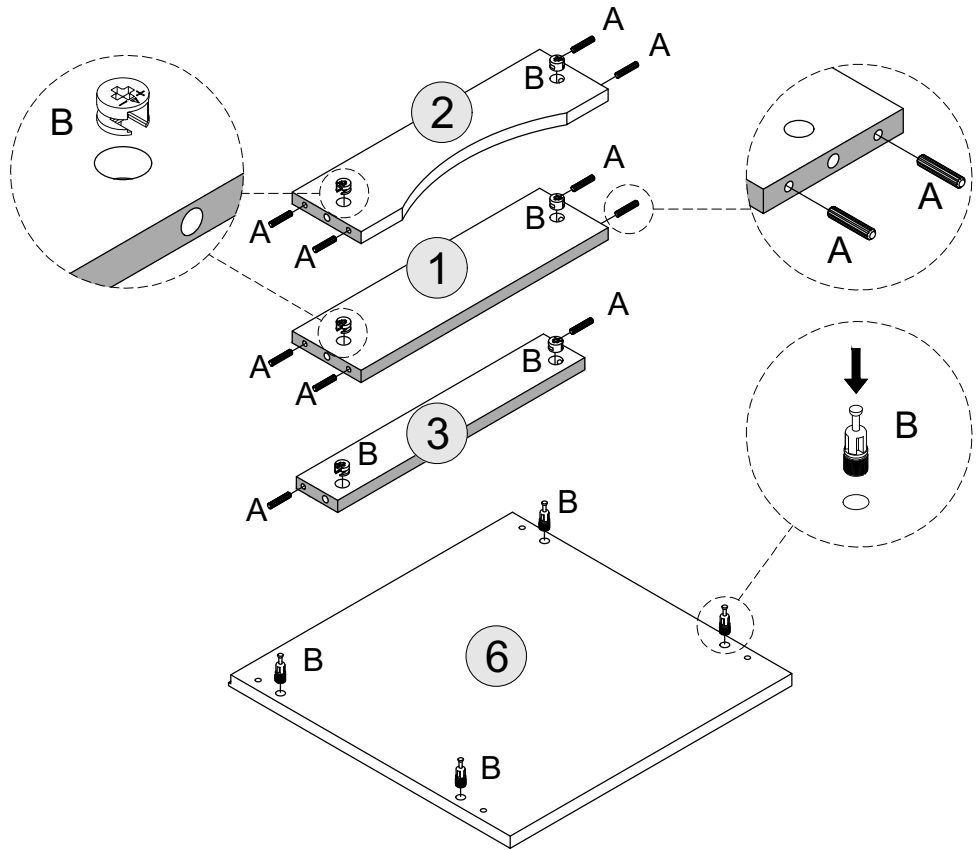
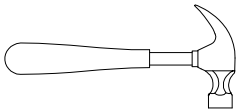





STEP 2

PARTS REQUIRED

4 - SIDE PANEL - LEFT	x1
-----------------------	----

HARDWARE REQUIRED

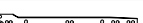
A		02
B		03
B		02
H		12
J		03

TOOLS REQUIRED

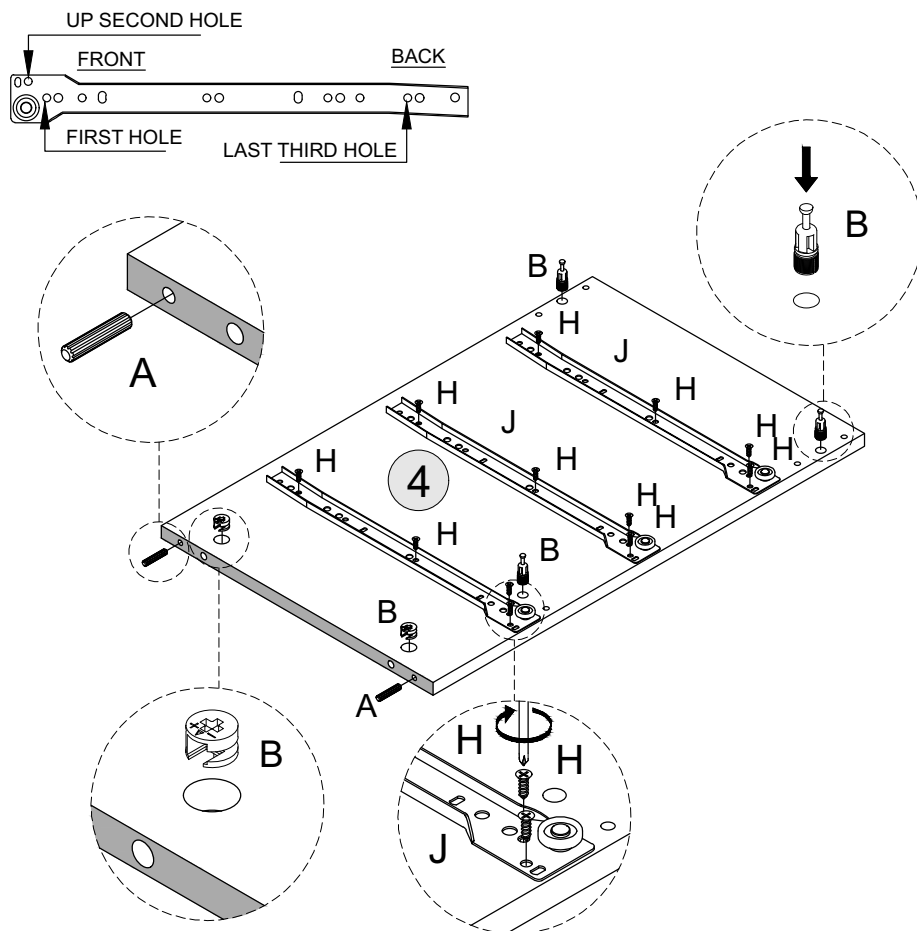
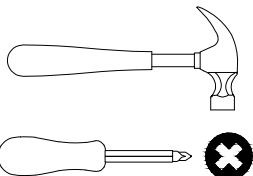





STEP 3

PARTS REQUIRED

5 - SIDE PANEL - RIGHT x1

HARDWARE REQUIRED

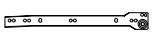
- A  02
- B  03
- B  02
- H  12
- J  03

TOOLS REQUIRED

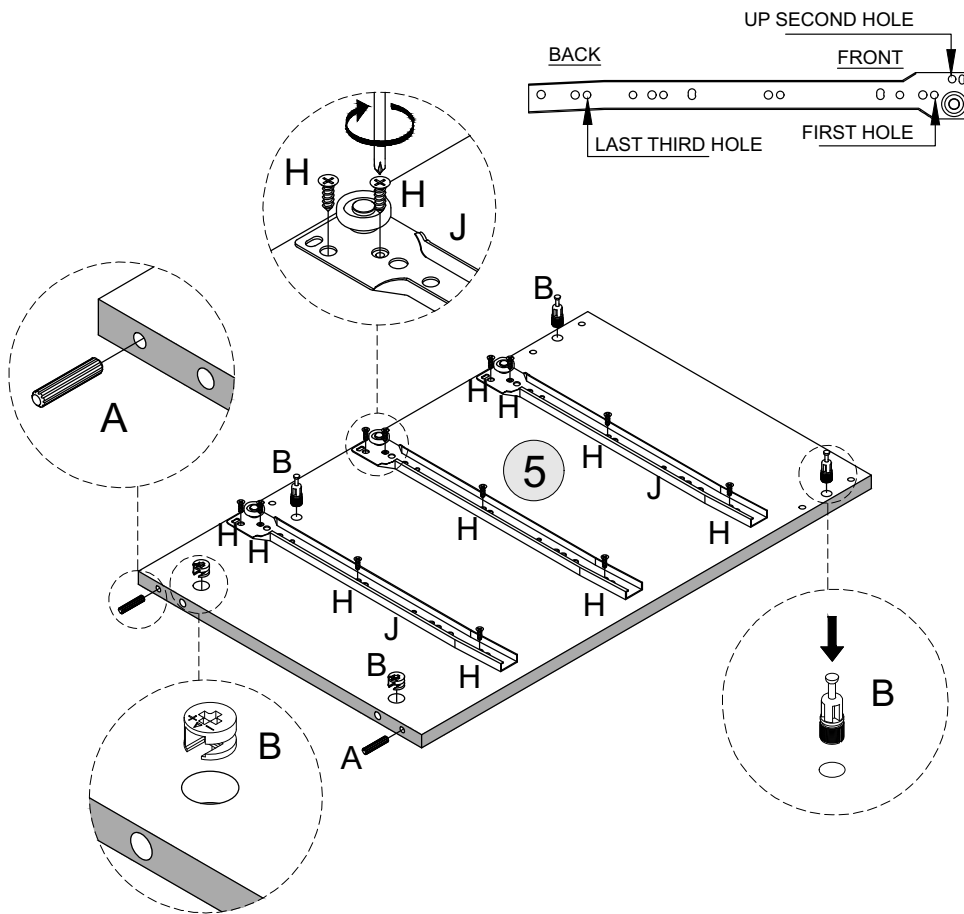
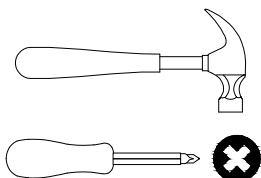

STEP 4

PARTS REQUIRED

- 1 - BACK PLINTH x1
- 2 - FRONT PLINTH x1
- 3 - FRONT CROSSBAR x1
- 4 - SIDE PANEL - LEFT x1

HARDWARE REQUIRED

TOOLS REQUIRED

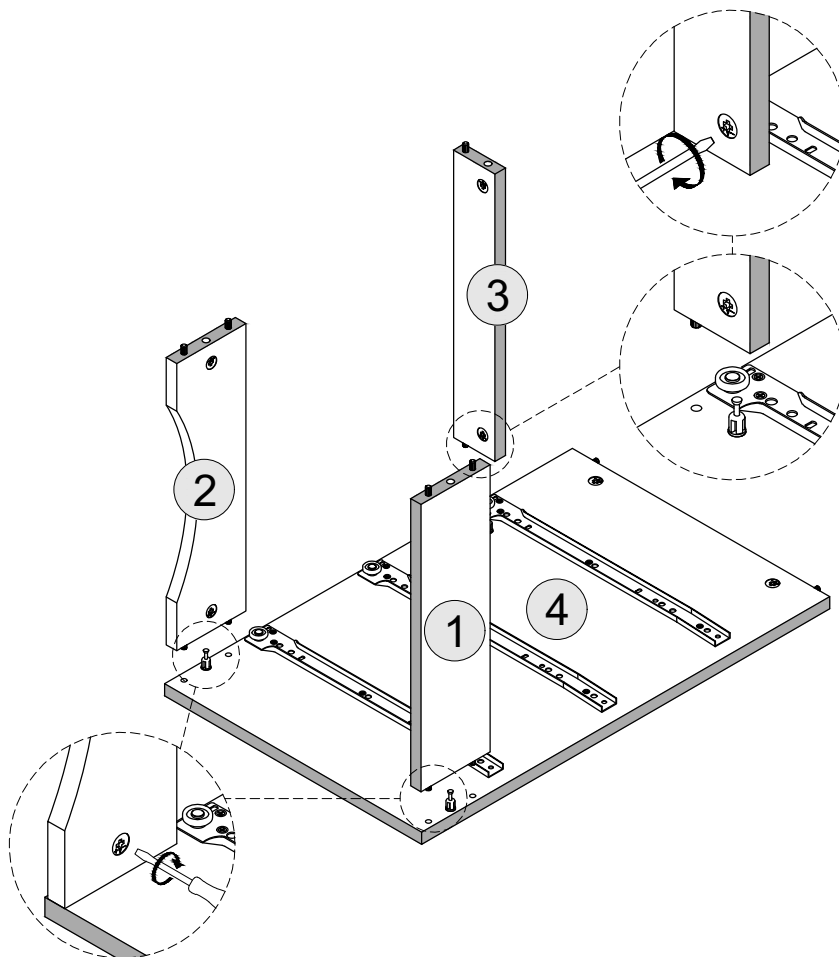
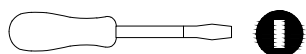

STEP 5

PARTS REQUIRED

5 - SIDE PANEL - RIGHT x1

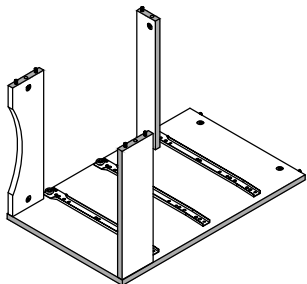

HARDWARE REQUIRED

TOOLS REQUIRED

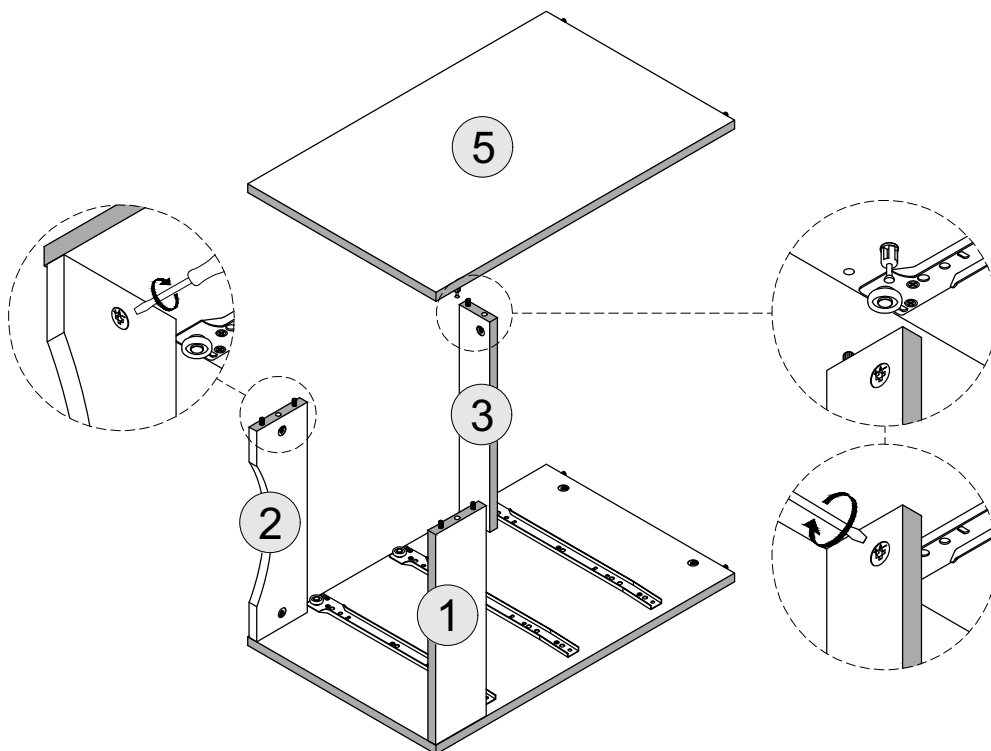
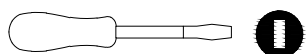

STEP 6

PARTS REQUIRED

6 - TOP PANEL x1

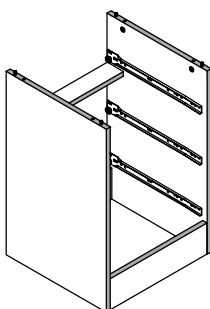

HARDWARE REQUIRED

TOOLS REQUIRED

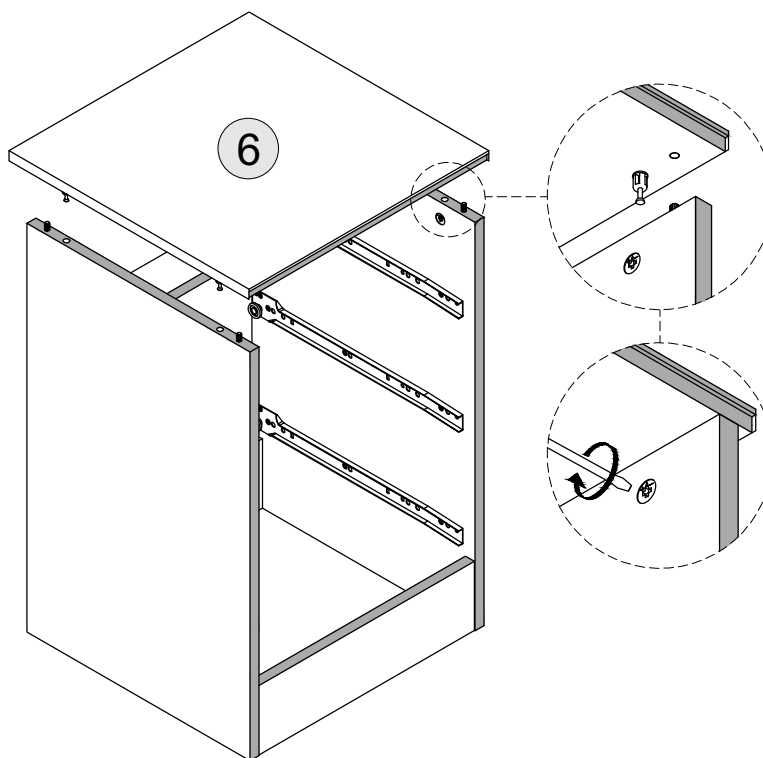
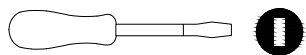

STEP 7

PARTS REQUIRED

7 - BACK PANEL x1

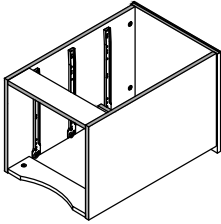

HARDWARE REQUIRED

C  04

D  04

E  11

H  03

TOOLS REQUIRED

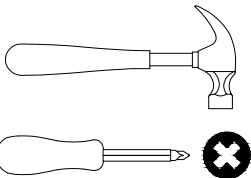

IMPORTANT PLEASE FOLLOW !

Ensure Part 7 is correctly aligned at the top before hammering Fitting E into the panel, as any misalignment will affect the final positioning of the drawers once assembled.

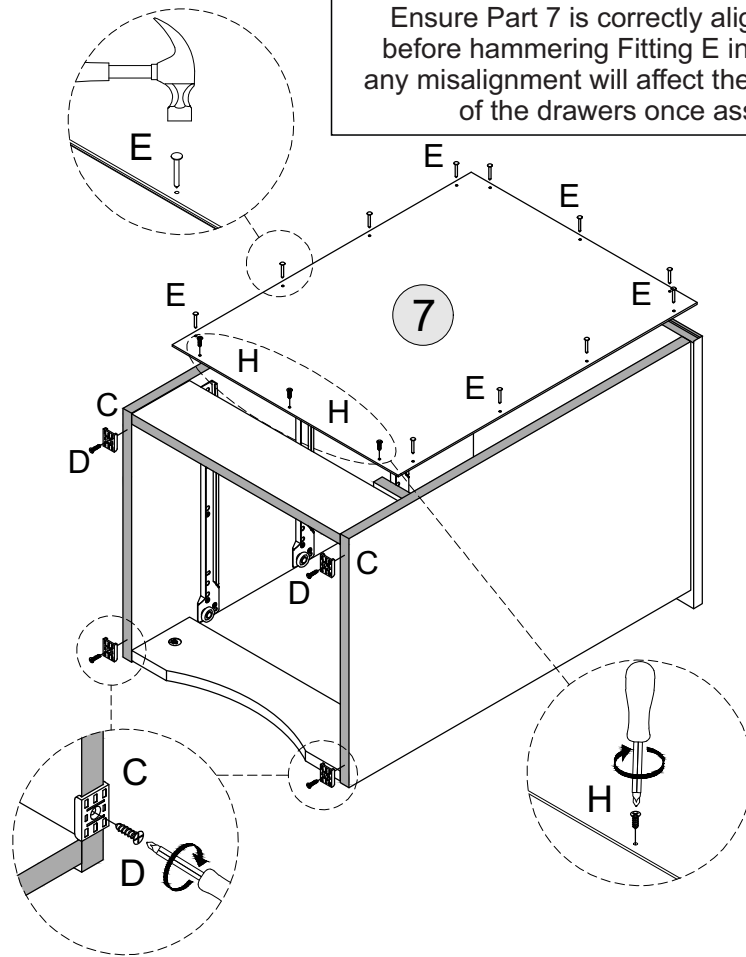

STEP 8

PARTS REQUIRED

8 - DRAWER BACK x3

9 - DRAWER SIDE - LEFT x3

10 - DRAWER SIDE- RIGHT x3

HARDWARE REQUIRED

A  24

B  06

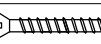
I  06

TOOLS REQUIRED

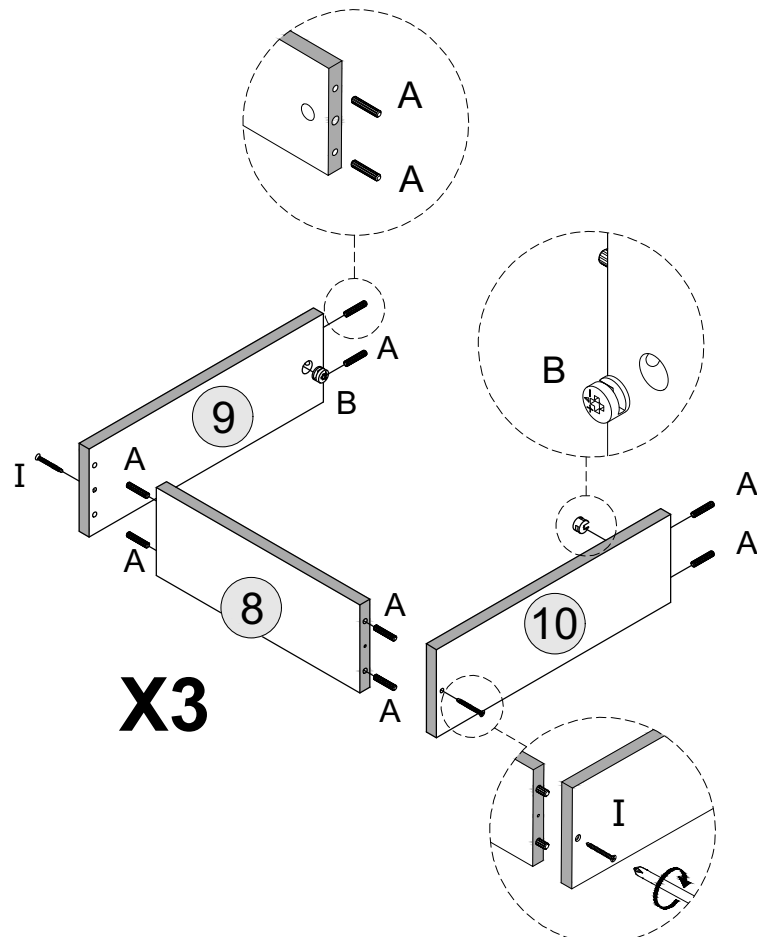
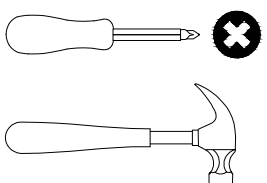

X3

STEP 9

PARTS REQUIRED

11 - DRAWER FRONT x3

HARDWARE REQUIRED

B  06

TOOLS REQUIRED

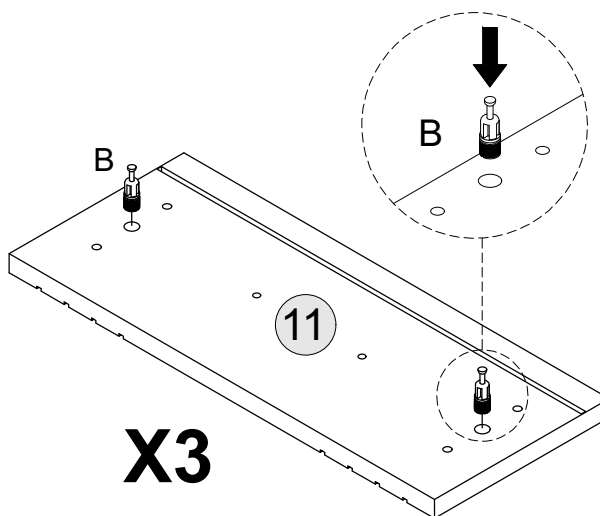

STEP 10

PART REQUIRED

11 - DRAWER FRONT x3

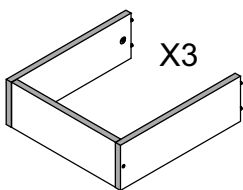

HARDWARE REQUIRED

F  06

G  03

TOOLS REQUIRED

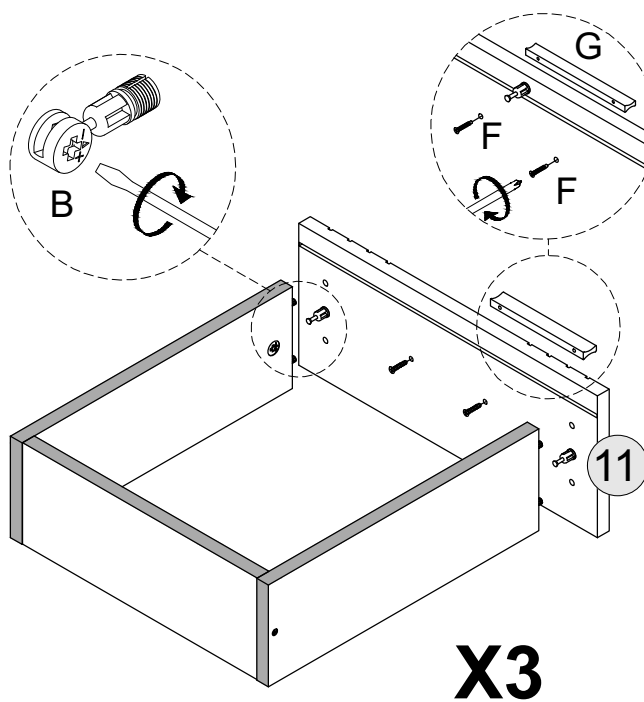
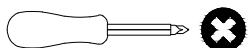
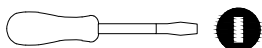

STEP 11

PARTS REQUIRED

12 - DRAWER BASE x3

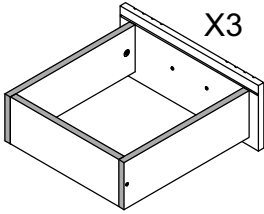

HARDWARE REQUIRED

E  12

TOOLS REQUIRED

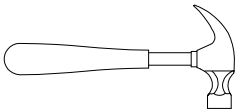

IMPORTANT PLEASE FOLLOW !

Ensure Part 12 is correctly aligned and square with the drawer frame before hammering Fitting E into the back, as any misalignment will affect the final positioning of the drawers once assembled.

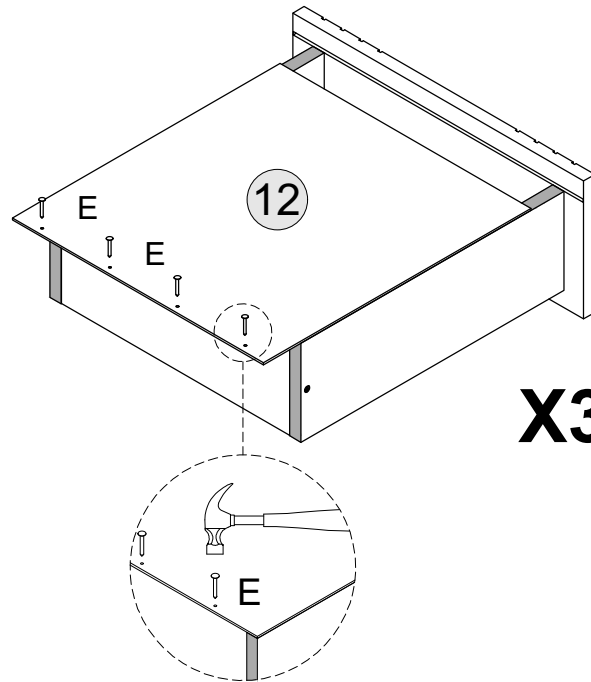

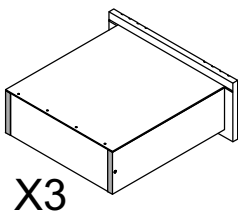

STEP 12

PARTS REQUIRED



HARDWARE REQUIRED

D  18

K  06

TOOLS REQUIRED

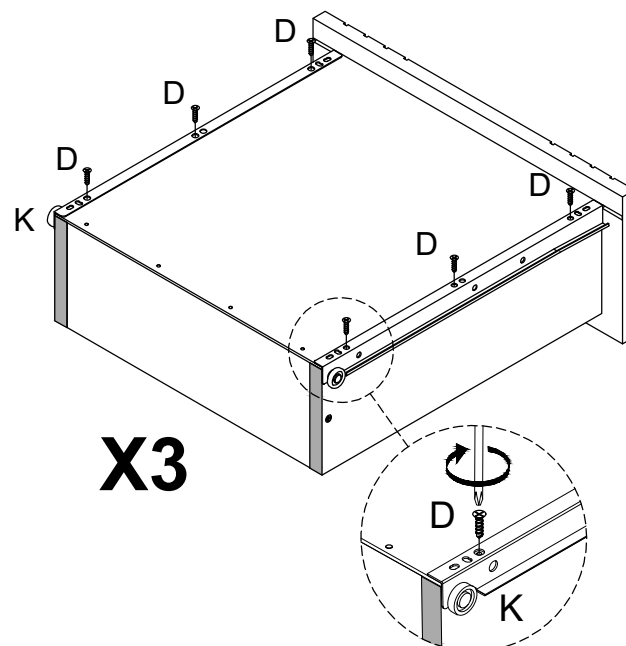
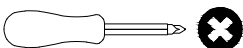

STEP 13

PARTS REQUIRED

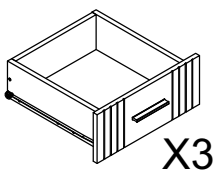
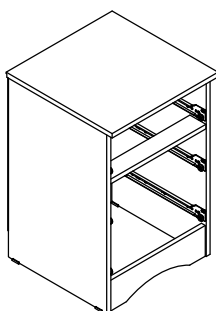

HARDWARE REQUIRED

TOOLS REQUIRED

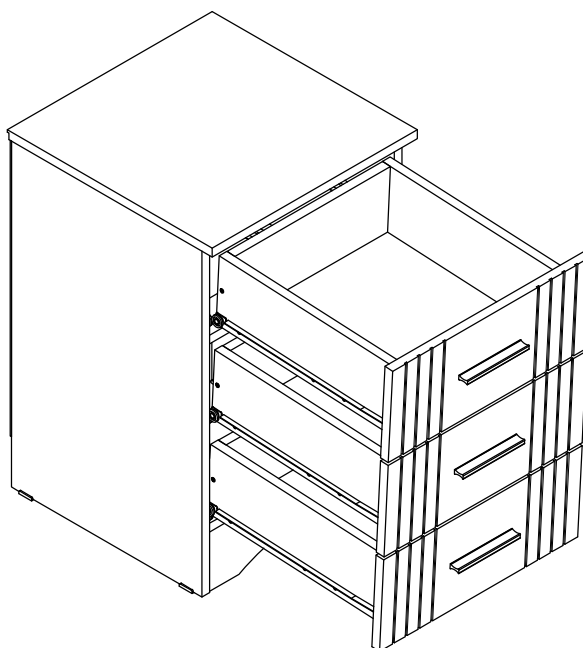

MAX WEIGHT



MAX DRAWER WEIGHT

STEP 14

PARTS REQUIRED

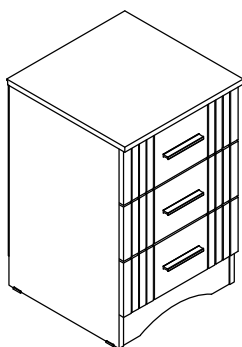

HARDWARE REQUIRED

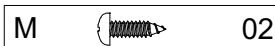

TOOLS REQUIRED



WARNING

Serious or fatal injuries can occur from furniture tipping over. To prevent the furniture from tipping over we recommend that it is permanently fixed to the wall.

Wall fixings are not supplied with this product as different wall materials require different types of fixing devices. Please make sure you use fixings suitable for the walls in your home.

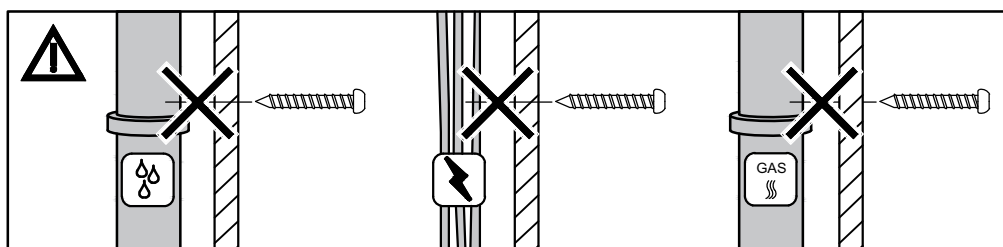
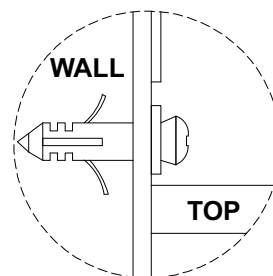
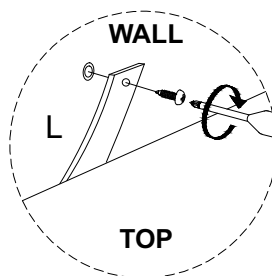
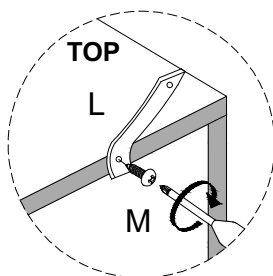

INFORMATIONS IMPORTANTES (FRENCH)

IMPORTANTE POUR USAGE DOMESTIQUE UNIQUEMENT VEUILLEZ LIRE AVANT DE CONTINUER

Le produit que vous avez acheté vous offrira de nombreuses années de service si vous suivez les directives pour son assemblage sûr et son entretien et nettoyage périodiques.

Assemblez sur une surface douce et propre.

N'utilisez aucun autre outil que ceux illustrés.

Toutes les clés ou clés Allen nécessaires sont fournies avec le kit de fixation.

N'utilisez en aucun cas un outil électrique pour assembler ce produit. Son utilisation invalidera toute réclamation que vous pourriez avoir et pourrait rendre ce produit dangereux.

Selon la quantité d'utilisation de ce produit, il peut être nécessaire de resserrer les fixations de temps en temps. Cela est tout à fait normal pour tout meuble en kit. Ne serrez pas trop les fixations.

Pour le nettoyage, vous pouvez utiliser un chiffon humide (pas mouillé).

N'utilisez pas de produits de polissage, de détergent ou de nettoyeurs chimiques.

La surface de cet article n'est pas résistante à la chaleur. Utilisez toujours un set de table sous les articles chauds ou froids pour éviter les marques.

ADVERTENCIA (ANTI-BASCULEMENT)

Des blessures graves, voire mortelles, peuvent survenir en cas de basculement d'un meuble. Pour éviter que le meuble ne bascule, nous recommandons de le fixer de manière permanente au mur.

Les fixations murales ne sont pas fournies avec ce produit, car les différents matériaux de mur nécessitent différents types de dispositifs de fixation. Veuillez vous assurer d'utiliser des fixations adaptées aux murs de votre maison. Veuillez vous référer à la dernière page.

INFORMACIÓN IMPORTANTE (SPANISH)

IMPORTANTE SOLO PARA USO DOMÉSTICO LEER ANTES DE CONTINUAR

El producto que ha adquirido le brindará muchos años de servicio si sigue las pautas para su montaje seguro y su mantenimiento y limpieza periódicos.

Ensamble sobre una superficie suave y limpia.

No utilice herramientas distintas a las que se muestran.

Las llaves inglesas o llaves Allen necesarias se incluyen con el kit de accesorios.

No utilice bajo ningún concepto una herramienta eléctrica para ensamblar este producto. Su uso invalidará cualquier reclamo que pueda tener y podría hacer que este producto sea inseguro.

Dependiendo de la cantidad de uso que reciba este producto, puede ser necesario apretar las fijaciones de vez en cuando. Esto es completamente normal para cualquier mueble en paquete plano. No apriete demasiado las fijaciones.

Para la limpieza, puede utilizar un paño húmedo (no mojado). No utilice abrillantadores, detergentes ni limpiadores químicos.

La superficie de este artículo no es resistente al calor. Utilice siempre un mantel individual debajo de los elementos calientes o fríos para evitar marcarlos.

ADVERTENCIA (ANTI-VUELCO)

El vuelco de los muebles puede provocar lesiones graves o fatales. Para evitar que los muebles se vuelquen, recomendamos fijarlos permanentemente a la pared.

Este producto no incluye fijaciones de pared, ya que los distintos materiales de pared requieren distintos tipos de dispositivos de fijación. Asegúrese de utilizar fijaciones adecuadas para las paredes de su hogar. Veuillez vous référer à la dernière page.

WICHTIGE INFORMATIONEN (GERMAN)

WICHTIGUR FÜR DEN HAUSHALTSGEBRAUCH BITTE LESEN SIE, BEVOR SIE FORTFAHREN

Das von Ihnen gekaufte Produkt wird Ihnen viele Jahre lang gute Dienste leisten, wenn Sie die Richtlinien für eine sichere Montage und regelmäßige Wartung und Reinigung befolgen.

Montieren Sie es auf einer weichen, sauberen Oberfläche.

Verwenden Sie keine anderen Werkzeuge als die abgebildeten.

Erforderliche Schraubenschlüssel oder Inbusschlüssel sind im Montagesatz enthalten.

Verwenden Sie unter keinen Umständen ein Elektrowerkzeug zur Montage dieses Produkts. Bei Verwendung erlöschen alle Ansprüche, die Sie haben, und das Produkt kann unsicher werden.

Je nachdem, wie häufig dieses Produkt verwendet wird, kann es erforderlich sein, die Befestigungen von Zeit zu Zeit festzuziehen. Dies ist bei Möbeln aus dem Bausatz völlig normal. Ziehen Sie die Befestigungen nicht zu fest an.

Zum Reinigen können Sie ein feuchtes Tuch verwenden (nicht nass).

Verwenden Sie keine Politur, kein Reinigungsmittel oder chemische Reiniger.

Die Oberfläche dieses Artikels ist nicht hitzebeständig. Verwenden Sie immer eine Unterlage unter heißen oder kalten Gegenständen, um Flecken zu vermeiden.

WARNUNG (KIPPSCHUTZ)

Durch das Umkippen von Möbeln können schwere oder tödliche Verletzungen entstehen. Um ein Umkippen der Möbel zu verhindern, empfehlen wir, diese dauerhaft an der Wand zu befestigen.

Wandbefestigungen werden nicht mit diesem Produkt mitgeliefert, da unterschiedliche Wandmaterialien unterschiedliche Arten von Befestigungsvorrichtungen erfordern. Bitte stellen Sie sicher, dass Sie Befestigungsvorrichtungen verwenden, die für die Wände in Ihrem Zuhause geeignet sind. Bitte beachten Sie die letzte Seite.

INFORMAZIONI IMPORTANTI (ITALIAN)

IMPORTANTE, SOLO PER USO DOMESTICO SI PREGA DI LEGGERE PRIMA DI CONTINUARE OLTRE

Il prodotto che hai acquistato ti garantirà molti anni di servizio se seguire le linee guida per il suo montaggio sicuro e periodico manutenzione e pulizia.

Montare su una superficie morbida e pulita.

Non utilizzare strumenti diversi da quelli mostrati.

Eventuali chiavi e chiavi a brugola necessarie sono incluse nel kit di raccordi.

Non utilizzare per nessun motivo un utensile elettrico per assemblare questo prodotto. Suo l'uso invaliderà qualsiasi reclamo tu possa avere e potresti avanzare su questo prodotto pericoloso.

A seconda della quantità di utilizzo che questo prodotto riceve, potrebbe essere necessario stringere di tanto in tanto i fissaggi.

Questo è completamente

normalmente per qualsiasi mobile flat pack. Non stringere eccessivamente il fissaggio.

Per la pulizia è possibile utilizzare un panno umido (non bagnato).

Non usare smalti, detersivi o detergenti chimici.

La superficie di questo articolo non è resistente al calore. Usa sempre una tovaglietta sotto oggetti caldi o freddi per evitare segni.

AVVERTIMENTO (ANTIRIBALTAMENTO)

Il ribaltamento dei mobili può provocare lesioni gravi e mortali. A evitare che i mobili si ribaltino, si consiglia di farlo fissato permanentemente al muro.

I fissaggi a parete non sono forniti con questo prodotto in quanto parete diversa i materiali richiedono diversi tipi di dispositivi di fissaggio. Per favore, fallo assicurati di utilizzare fissaggi adatti alle pareti della tua casa. Si prega di fare riferimento all'ultima pagina.