

HOROW®

Installation & User Manual

HOROW X70

Smart Toilet

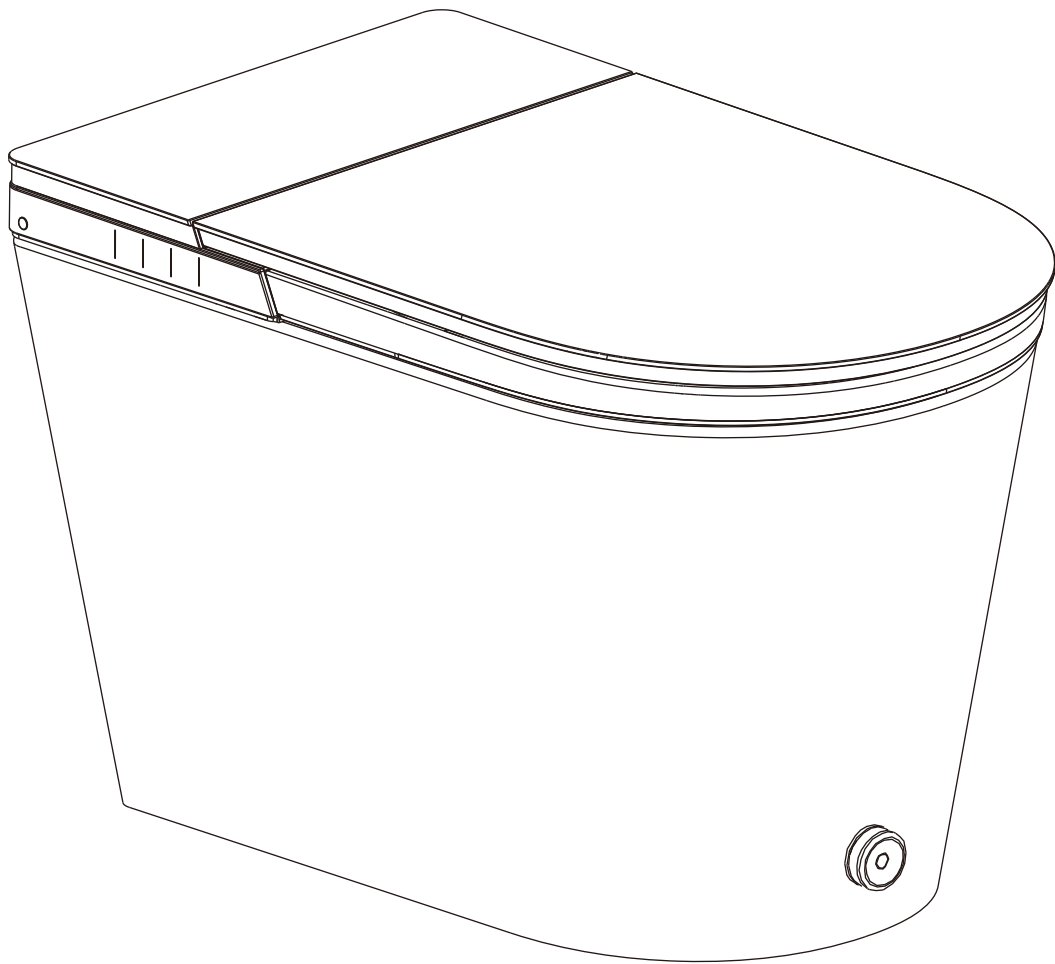

Contents

Important Safeguards	1
Important Information	1
Grounding Instructions	2
Explanation of Terms and Symbols	2
Overall Sketch	8
Function Table	9
Product Installation	10
Tools Needed for Installation	10
Parts Included	10
Prior to Installation	11
Installation of Smart Toilet	12
Installation of Remote Control Holder	15
Product Test Run	16
Usage Instructions	17
Function Explanations	17
Kick Control Operations	23
Side Button Operations	24
Remote Control Operations	25
Daily Maintenance	31
Maintenance of Ceramics, Seat and Lid	31
Maintenance of the Nozzle	32
Maintenance During Winter Season	32
Troubleshooting	33
Specifications	35
Warranty	36

- Thank You for Choosing HOROW. Please read the instructions carefully before installation and keep it available for future maintenance or reference.
- We are not responsible for the accidents resulting from the user's negligence.
- HOROW reserves the right to make revisions to this manual without notice.



Need help? Contact HOROW Customer Service Team.

Phone: (+1)209-200-8033

Monday to Friday

Email: support@horow.com

Important Safeguards

Read All Instructions Before Using

Important Information

When using electrical products, especially when children are present, basic safety precautions should always be followed, including the following:



DANGER - To reduce the risk of electrocution:

1. Do not use while bathing.
2. Do not place or store product where it can fall or be pulled into a tub or sink.
3. Do not place in or drop into water or other liquid.
4. Do not reach for a product that has fallen into water. Unplug it immediately.
5. Do not wash the main unit or electrical plug with water or detergent.
6. During installation, disassembly, repair and maintenance of the product, the power plug must be switched off and the water supply be shut off.



WARNING - To reduce the risk of burns, electrocution, fire, or injury to persons:

1. Close supervision is necessary when this product is used by, on, or near children or invalids.
2. Use this product only for its intended use as described in this manual. Do not use attachments not recommended by HOROW.
3. Never operate this product if the cord or plug is damaged, if it is not working properly, or if it has been dropped, damaged, or immersed in water. If any of these conditions apply, contact our Customer Service Team directly.
4. Keep the cord away from heated surfaces.
5. Never block the air openings of the product or place it on a soft surface, such as a bed or couch, where the openings could be blocked. Ensure that the air openings remain free of lint, hair, and similar debris.
6. Never use while sleeping or drowsy.
7. Never drop or insert any object into any opening or hose.
8. Do not use outdoors or in environments where aerosol (spray) products are being used or oxygen is being administered.
9. Connect this product to a properly grounded outlet only.
See **Grounding Instructions**.
10. Caution - Risk of electric shock. Do not remove the toilet lid (or back) on your own. Refer servicing to qualified service personnel.

Grounding Instructions

This product should be grounded. In the event of an electrical short circuit, grounding reduces the risk of electric shock by providing an escape wire for the electric current. The product is equipped with a cord that has a grounding wire and a grounding plug. The plug must be inserted into an outlet that is properly installed and grounded.



DANGER - Improper use of the grounding plug can result in a risk of electric shock.

1. If repair or replacement of the cord or plug is necessary, do not connect the grounding wire to either flat blade terminal. The wire within insulation having an outer surface that is green with or without yellow stripes is the grounding wire.
2. Check with a qualified electrician or serviceman if the grounding instructions are not completely understood, or if in doubt as to whether the product is properly grounded.
3. This product is factory equipped with a specific electric cord and plug to permit connection to a proper electric circuit. Make sure that the product is connected to an outlet having the same configuration as the plug.
4. No adapter should be used with this product. Do not modify the plug provided - if it will not fit the outlet, have the proper outlet installed by a qualified electrician. If the product must be reconnected for use on a different type of electric circuit, the reconnection should be made by qualified service personnel.

Explanation of Terms and Symbols

To ensure proper and safe use of this product, please read this section carefully before use. After reading, store this manual in a safe place for any needed future reference.

The hazards and warnings listed herein are important to our user's safety. Significant consequences may result from failure to heed warnings. The company will not be held liable for any injuries or damages caused by improper use or failure to follow the safety instructions.

Warning

Indicate possible injury resulting from improper usage due to negligence of this sign.

Attention

Indicate human injury or property loss that may result from improper usage due to negligence of this sign.



Indicate a strict request to follow noted precautions when used with the above "Warning" and "Attention" signs.



Prohibit any individual from performing any action with this symbol.



Prohibit any individual from dismantling product.



Keep product away from any wet environments, including, but is not limited to, humid environments, close proximities to baths, showers or sinks.

 Do not touch!

 Operate only as instructed!

 Do not touch with a wet hand!

 Pull out the power plug!

 Keep away from any extreme heat or fire!

 Protective grounding.

Warning

This product needs to be properly grounded.

- ※ Risk of electric shock.
- ※ If unsure, contact an electrician.



Do not place a lit cigarette along with other burning objects into the unit.

- ※ Risk of fire.



Do not touch, insert or pull out the power plug with a wet hand.

- ※ Risk of electric shock.



Do not use during thunderstorms (pull out the power plug during storms).

- ※ Failure in doing so may lead to injury or fault in the product.



Do not use a power socket in poor condition or a damaged power plug.

- ※ Risk of fire and/or electric shock.

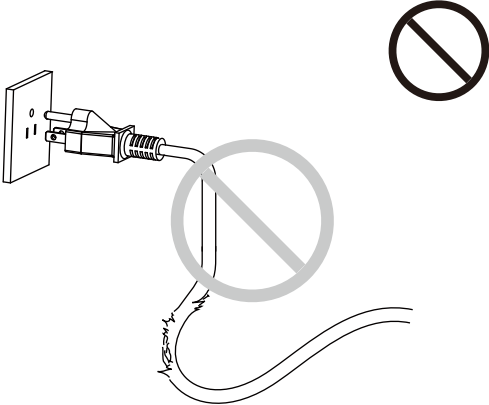

When the seat or the lid is damaged, to avoid any harm, be sure to pull off the power plug, close the water source and contact your local electrical installation company for replacement.

- ※ Risk of fire and/or electric shock.



The power socket in use should be within the specified range.

- ※ Risk of fire and/or electric shock.

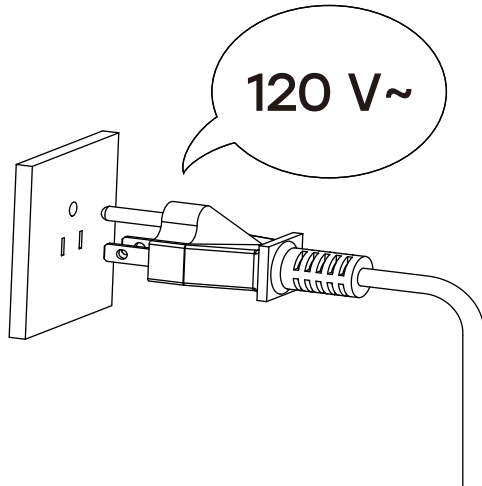

Regularly pull out the power plug and wipe off any dust on the power plug using a clean dry cloth.

- ※ Risk of fire.



Any person with a disability, the elderly, and children should be using this product with the supervision of another individual.

- ※ Be advised that sitting on the heated seat for an extended amount of time may result in burns.



Do not pull, damage, bend, twist, stretch, roll, bundle, clamp or squeeze the cord. Do not place anything on the cord.

- ※ Risk of fire and/or electric shock.



This product is not a toy. Advise children not to play with product.

- ※ Risk of injury.



If the power cord is damaged, to prevent any injuries or accidents, it should be replaced by a professional.

- ※ Risk of fire and/or electric shock.



Do not dismantle, repair or alter this product on your own. Call in a professional for further advice.

- ※ Risk of fire, electric shock, and/or other accident that may lead to injury.



For cleaning or maintenance of plastic parts, do not use any harsh cleaning agents. (These include, but are not limited to products such as concentrated sulfuric acid, concentrated nitric acid, glacial acetic acid, carbon tetrachloride, chloroform, benzene, phenol, methylphenol, dimethylformamide, methyl ether, soybean oil, acetate, 40% nitric acid, thick salt acid, 95% alcohol, gasoline, kerosene, etc.)



※ Risk of damaging parts that can lead to accidents and injuries.

Do not use polluted water or water meant for industrial use.



- ※ Risk of cystitis and dermatitis.
- ※ Untreated water may also cause internal corrosion of the product and may cause electrical shock or a fire.

Do not apply any force to the unit's seat and lid. Do not stand on the lid or open or close the lid and the seat forcefully.

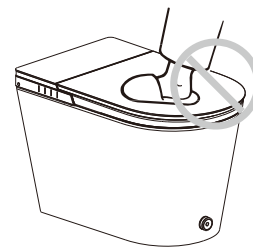

※ Risk of product damage and/or user injury.

Do not add water or detergent into the unit or onto the wireless remote control. Do not soak the product with water or cleaner.



※ Risk of fire and/or electric shock.

Do not install the product in a humid environment or a soaked room. Do not spray or soak this product with any form of liquid to prevent any damage to the product.



※ Risk of fire, electric shock, and/or other accident that may lead to user injury.

Do not place your hand or any other object into the dryer trap, and do not cover the dryer and dryer trap during product use.

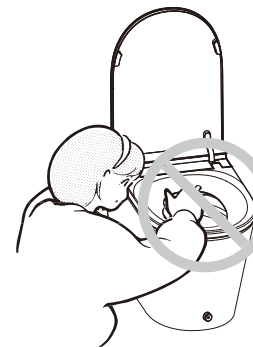

※ Risk of fire, electric shock and/or other accident that may lead to user injury.

Do not spray urine at the dryer.



※ Risk of electric shock.

 **Battery Warning**

Read the following for proper battery usage.

- ① Properly install the battery according to its correct polarity.
- ② Remove the battery during long periods without use.
- ③ Replace the battery in time.
 - ✘ Failure to do so may result in interrupted control signals.
- ④ Cover the battery with tape before disposal. This will prevent battery fluid leaks that may cause fire and/or other damages.
- ⑤ Place the battery out of children and infant reach.
 - ✘ If battery is swallowed, contact a doctor immediately.
- ⑥ If battery fluid leaks onto user, quickly rinse off using clean water.
- ⑦ If battery fluid gets into eyes, do not rub your eyes. Quickly rinse it with clean water and consult a doctor immediately.
 - ✘ Failure to do so may result in vision impairment or blindness.

**When the battery is in use, do not do the following operations:**

- ① Do not hold or store with metal objects (such as a necklace or a watch).
- ② Do not mix new and old batteries.
- ③ Do not pull apart battery or throw it into water and/or fire. Battery fluids may cause a fire.



 **Attention**

Do not use the heated seat or warm dryer temperature for an extended amount of time.

- ※ Extended use may result in burns.



Avoid direct sunlight or heat.

- ※ Risk of product discoloration.



While using this product, make sure that the skin is in contact with the seat sensor area. Otherwise, the product may not operate correctly.

- ※ Children and smaller individuals may have trouble staying in contact with sensor area.

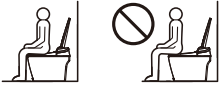

Do not spray urine in the direction of the bidet nozzle.

- ※ Doing so may result in blockage to the bidet nozzles and cleaning area.



Do not turn the product upside down if it is disassembled and reinstalled, as this may cause internal damage.

- ※ Risk of product damage.



Do not supply electricity with an external switch, i.e., connecting the universal part to a timer switch.

- ※ Risk of problems caused by improperly resetting the thermal breaker.



Pull out the power plug when the product is in disuse for an extended amount of time. Make sure to shut off the water and remove the water inside the product.

- ※ Risk of fire, leakage and product damage.



When storing or transporting in cold climate, make sure to remove all water from the unit. Product may crack and other damages may occur due to freezing water.

- ※ Risk of fire, leakage and product damage.



In case of sudden power failure, pull out the power plug and turn off the angle valve to prevent water leakage.

- ※ Risk of water leakage and/or property loss.



Overall Sketch

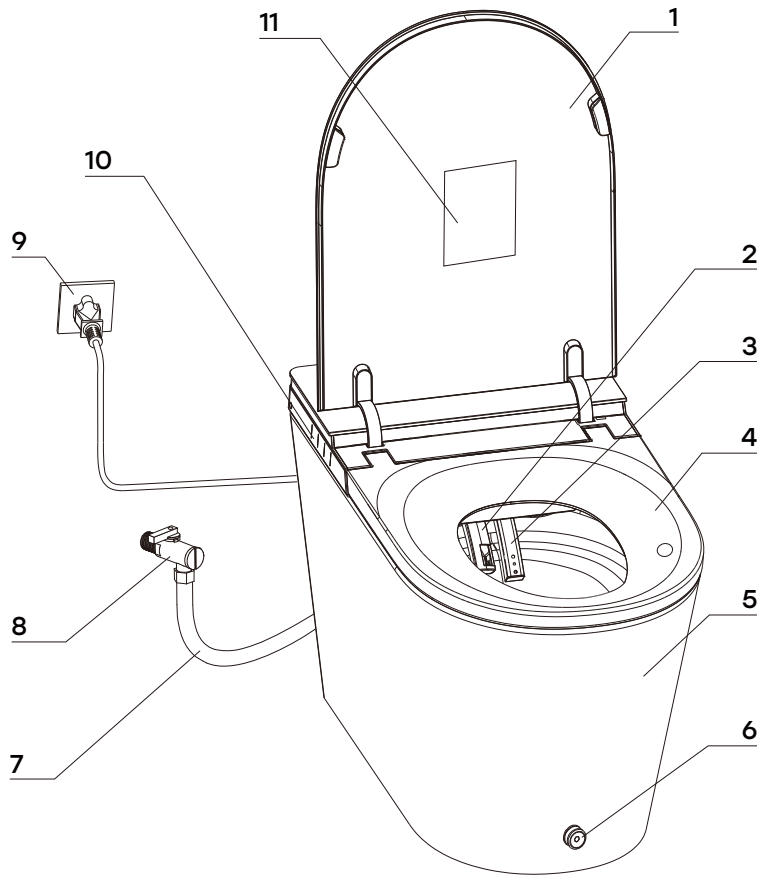

1	Lid
2	Warm Dryer
3	Detachable Nozzle
4	Heated Seat
5	Ceramic Toilet Bowl
6	Kick Control
7	Water Hose
8	Angle Valve
9	Power Plug
10	Side Button
11	Caution

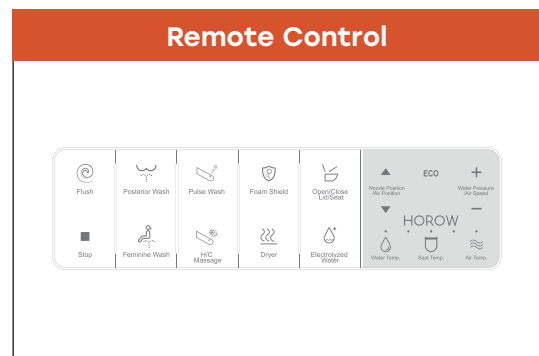
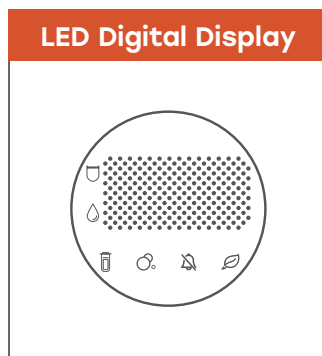
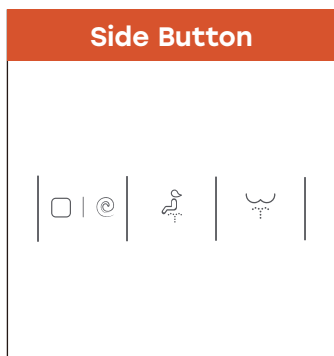

※ Two AAA batteries for the remote control are included in the product package.

Function Table

Category	Functions	Model	X70
Hygiene	Feminine Wash		●
	Posterior Wash		●
	Movement Wash		●
	Child Wash		●
	H/C Massage		●
	Self-cleaning Nozzle		●
	Detachable Nozzle		●
	Nozzle Clean		●
	UV Nozzle Purification		●
	Electrolyzed Water Purification		●
	UVC Water Purification		●
	Hygienic Seat		●
	Easy-clean Glaze		●
Pre-wet		●	
Comfort	Instant Heating		●
	Adjustable Water Temperature		●
	Adjustable Water Pressure		●
	Adjustable Nozzle Position		●
	Heated Seat		●
	Adjustable Seat Temperature		●
	Warm Dryer		●
	Movement Drying		●
	Adjustable Dryer Temperature		●
	Foam Shield		●
	Auto Deodorization		●
Convenience	Auto Open Lid		●
	Auto Wash		●
	Auto Flush		●
	Drying Flush		●
	Blackout Flush		●
	Remote Flush		●
	LED Digital Display		●
	Remote Open Lid/Seat		●
	Kick Open Lid/Seat		●
	Night Light		●
	Rhythmic Ambient Light		●
	Energy-saving Mode		●
	Four Seasons Temperature Sensing		●
	Soft Close		●
Factory Data Reset		●	
Safety	Prolonged Sitting Reminder		●
	Air Isolation & Backflow Prevention		●
	Multiple Protections		●
	Fire and Heat Resistant		●

Product Installation





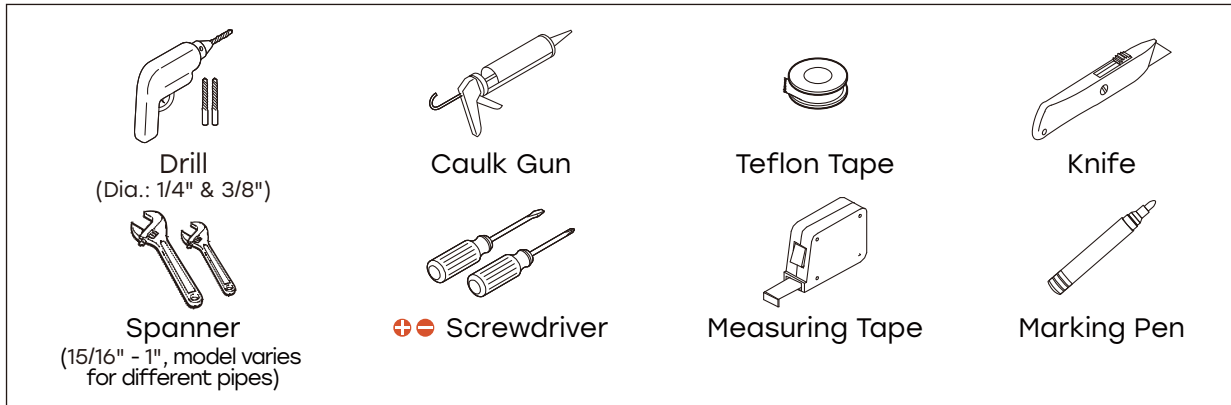





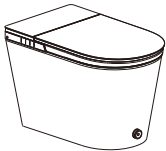
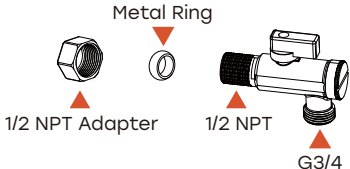

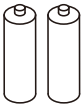
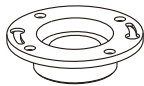
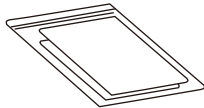
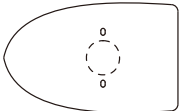
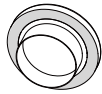
Tools Needed for Installation

Please have these tools prepared prior to installation.



Parts Included

Please confirm that all items below are inside the box.

<p>Smart Toilet (1 pc)</p> 	<p>Angle Valve & Adapter (1 pc)</p> 	<p>Remote Control Set (1 pc)</p>  <p>(holder 1 pc, screw 2 pcs)</p>
<p>Two AAA Batteries</p> 	<p>Floor Flange (1 pc)</p> 	<p>Installation & User Manual</p> 
<p>Installation Template (1 pc)</p> 	<p>Wax Ring (1 pc)</p> 	
<p>Mounting Accessory Kit:</p> <ul style="list-style-type: none"> <li style="width: 33%;"> Expansion Bolt (4 pcs) <li style="width: 33%;"> Mounting Block (2 pcs) <li style="width: 33%;"> Fixing Sleeve (2 pcs) <li style="width: 33%;"> Screw (4 pcs) <li style="width: 33%;"> Toilet Screw (2 pcs) <li style="width: 33%;"> Bolt (2 pcs) <li style="width: 33%;"> Washer (6 pcs) <li style="width: 33%;"> Nut (2 pcs) <li style="width: 33%;"> Decorative Cap (2 pcs) 		

Prior to Installation

Please confirm that all the aforementioned items in the package are present. In case of any missing parts, please feel free to contact our Customer Service Team. Illustrations above are for reference only. The ceramic product may have slight deformation during the firing process. Please consult the actual product for accurate details.

Verify the product dimensions and secure enough installation space. The rough-in size refers to the distance between the center of the toilet flange to the finished back wall.

※ All dimensions are manually measured with a certain degree of error. For the specific size, please refer to the actual product received.

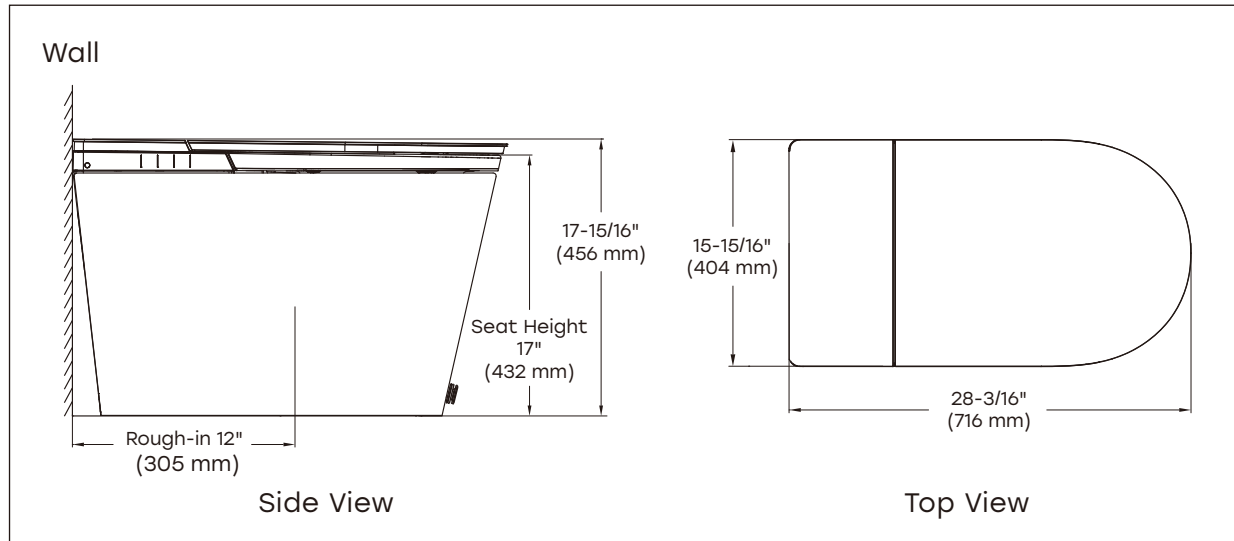

To ensure proper installation, the distance between the water supply valve and the centerline of the toilet should be greater than half the width of the toilet bottom. The water supply valve should be about 8" (203 mm) away from the toilet centerline. For larger valves, a greater distance may be necessary to ensure proper clearance. For easy installation and maintenance, a range of 9" (229 mm) to 11" (279 mm) is recommended.

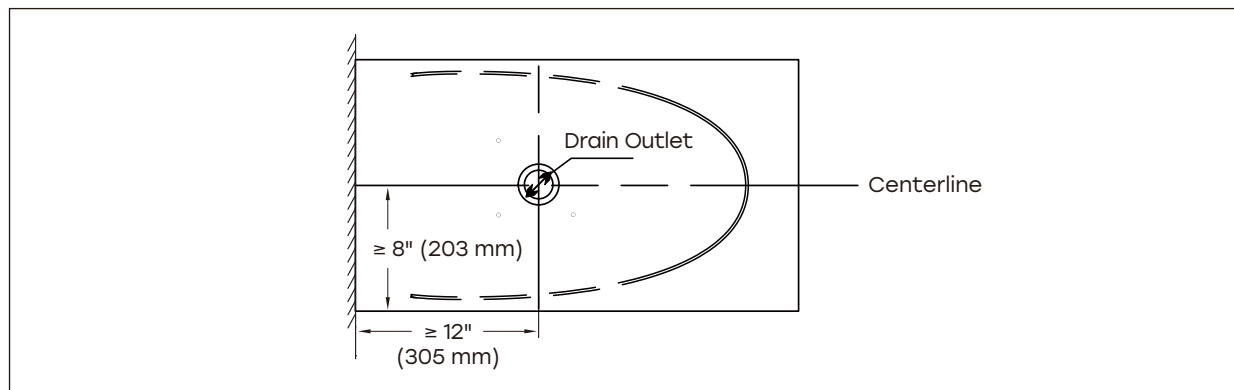

The minimum water pressure required is 8.7 psi, and the maximum water pressure is 116 psi. If the minimum water pressure is not met, the smart toilet may not achieve the optimal cleaning performance. However, since the product includes a built-in water tank and pump, its ceramic scouring effect is not affected by external water flow, pressure, or other environmental factors.

Electrical requirements for this product: 16 Amps at AC 120 V, 60 Hz.

Installation of Smart Toilet

Install your toilet using the following steps:

Please remove the old toilet first if any and ensure the mounting surface is clean and level before the new toilet is installed.

1 Open the box right side up

Remove the accessories first, then lift the toilet with two people, remove the packaging, and gently place the toilet on the floor, as shown in the diagrams below.

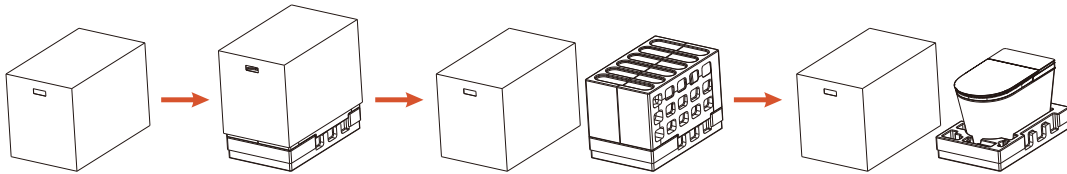

2 Install the angle valve

Turn off the water supply and then remove the existing supply stop valve.

Turn on the water supply and flush for 1 minute to clear any debris that may damage the toilet structure.

Turn off the water supply. Wrap Teflon tape around the threaded end of the water supply pipe to ensure a watertight seal. Screw the needed adapter onto the water supply pipe based on actual requirement.

Connect the angle valve to the water supply pipe, using a gasket to prevent water leakage.

- ※ If your water supply pipe is a copper pipe, you can use the adapter and the metal ring provided to let the copper match the angle valve.
- ※ For the joint assembly, tighten the threaded joint 1 ~ 2 turns beyond finger tight, ensuring not to overtighten.

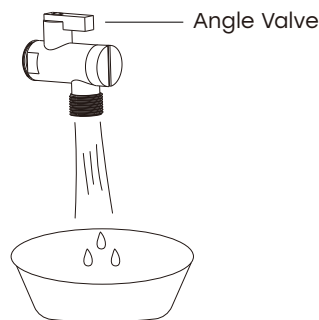

3 Install with installation template

Align the installation template with the centerline of drain outlet. Mark four mounting holes based on the installation template with the marking pen. Then, outline the edges of the template to mark the toilet placement for later installation and remove the installation template.

4 Install and fix the flange

Drill four 3/8" (10 mm) holes at the marked locations from the previous step. Insert four expansion bolts into the holes. Position the flange on the drain pipe outlet, aligning the four flange holes with the drilled holes on the ground. Then, insert the washers and screws into the flange holes and tighten them using a screwdriver.

※ If an applicable flange is already in place, there is no need to install the new one.

5 Install the mounting blocks

Assemble the mounting blocks with bolts, position the two mounting blocks on opposite sides of the flange on the ground and secure them with washers and nuts.

6 Install the ceramic toilet

Install the wax ring onto the drain hole at the bottom of the ceramic toilet and press it firmly into place.

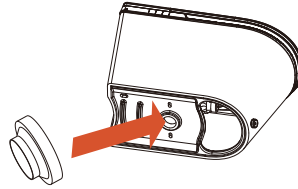

Lift the ceramic toilet with two people and gently lower it onto the flange, letting it well fit the mounting blocks.

Press down firmly on the ceramic toilet to ensure the wax ring forms a complete seal.

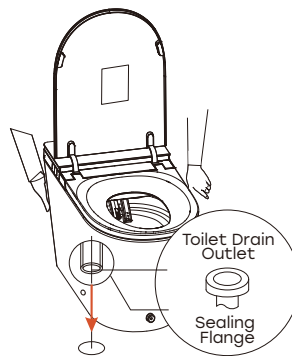

Insert the screw through the fixing sleeve, then through the holes on both sides of the ceramic toilet and into the mounting blocks on the ground. Tighten them securely using a screwdriver.

Put the decorative cap onto the fixing sleeve.

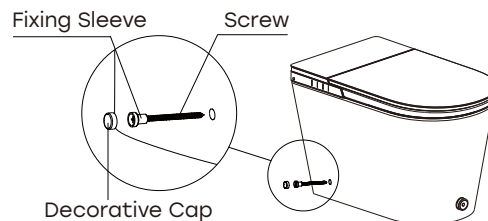

Tips:

- ✘ The toilet is heavy, and it needs two people to carry it.
- ✘ Please clean the drain outlet.
- ✘ Please make sure ceramic toilet outlet sits perfectly on the drain outlet.

7 Install the water hose

Connect the water hose to the installed angle valve and tighten it.

Use Teflon tape on all threaded connections to ensure a watertight seal.

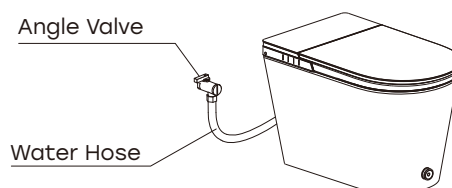

Installation of Remote Control Holder



Drill two 1/4" (6 mm) holes in the wall (about 1-3/4" (45 mm) deep).
 Knock the anchors into the hole with a hammer.
 Secure the holder with anchors.
 Use the screws to secure the holder to the wall.
 Remove the battery cover from the backside of the remote control to install batteries.
 Once finished, the remote control is ready to be placed in its holder.

Detailed steps are shown in the diagrams below:

- ※ Please use proper mounting tools for special wall surfaces (such as wood, HDF, etc.)
- ※ The remote control holder should be installed away from the bidet's spray trajectory.
- ※ The remote control holder should be installed within reach when seated on the toilet.
- ※ Make sure there is nothing to block the transmission between the toilet and its remote control.

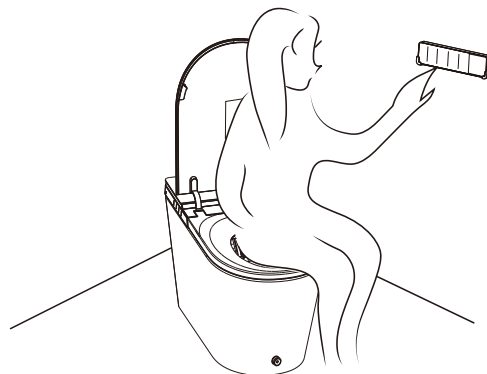

Steps:

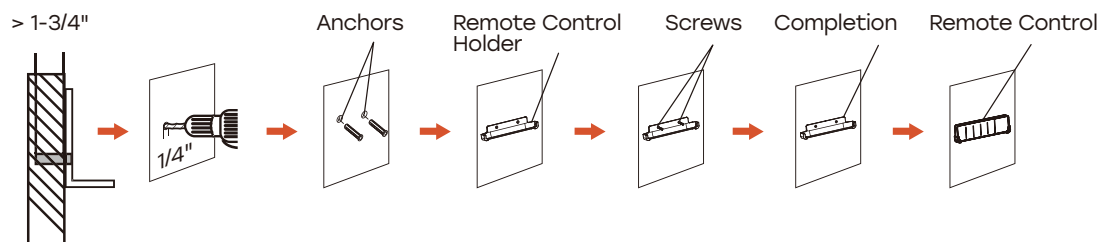

Product Test Run

1 Water Connection

Turn the water supply angle valve to the maximum opening, as shown in the diagram.

Make sure no leakage is found at various connection parts.

※ In case of any water leakage, unfasten the nuts and install them again.

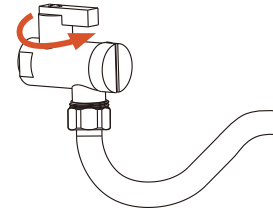

2 Power Connection

Ensure the electrical requirements are met: 16 A at AC 120 V, 60 Hz.

Plug the power plug into AC 120 V socket.

Press the side button  on the toilet to start a flush and confirm the toilet is powered on.

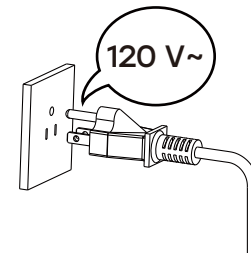

3 Smart Toilet Running

Are all functions working properly?

Test all function buttons on the remote control and the side buttons on the toilet. Verify the normal operation of each function.

Operate the remote control and confirm the functionality of Posterior Wash, Feminine Wash (including water pressure and nozzle position adjustment), Warm Dryer, Air Temperature and Water Temperature Adjustment, Nozzle Clean and Night Light.

All functions listed above should be tested. Please ensure all specified functions run correctly. Posterior wash, feminine wash and warm air drying functions should be tested while the seat is occupied.

After the toilet is installed and the test run is completed, it is recommended that you apply the silicone sealant around the base of the toilet. Please avoid applying sealant where the access covers meet the floor.

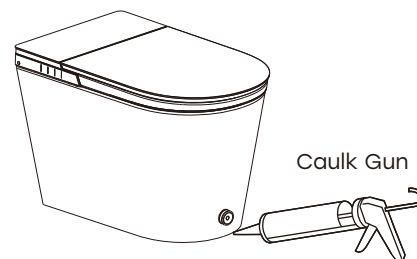
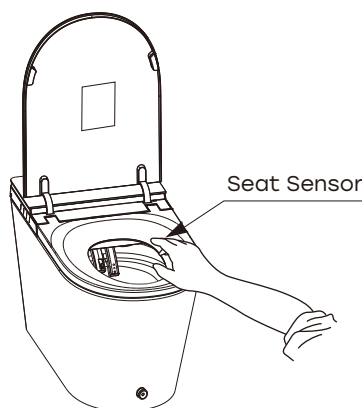

Usage Instructions

Function Explanations



Auto Flush

The toilet will automatically flush with the lid closed after the seat sensor no longer detects a user if no flush is performed during seat occupancy. Additionally, the toilet will automatically flush after the seat and lid are closed, if a male user urinates while the seat is unoccupied and open.



Drying Flush

Press **Dryer** on the remote control to activate the dryer to blow warm air. If no flush is executed after posterior or feminine wash, a flush will be performed automatically to avoid unpleasant odors before the dryer is activated. Posterior/feminine wash is not available during the flush process.

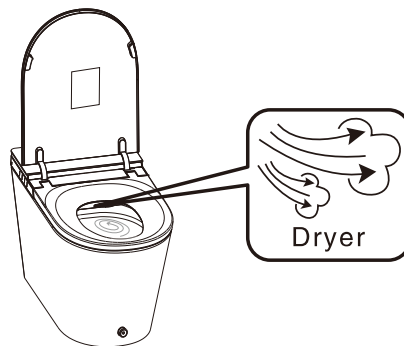



Blackout Flush

Blackout flush refers to the manual emergency flush during a power outage. No battery pack is required for this function. Follow the steps below to perform a blackout flush.

1. When facing the toilet, press both hands firmly on the decorative panel and push it to the right to remove it.
2. Pull up the flush lever as shown below to start side flush from the rim. Hold the lever in the raised position for about 10 seconds to raise the water level until it stops rising and remains unchanged.
3. Press down the flush lever to rapidly drain the water and activate the bottom flush. Hold for about 10 seconds until all waste is fully discharged from the ceramic bowl.
- ✘ During power outages, the flushing function relies on water pressure. A minimum inlet water pressure of 29 psi is required for proper performance. If the water pressure is sufficient, the lever holding duration in Step 2, 3 and 4 can be shortened appropriately.
4. Pull up the flush lever again to restart water flow from the rim. Maintain this position for about 5 seconds until the water level returns to normal.
- ✘ If waste remains, repeat Steps 2-4 until the bowl is clean.
5. Align the decorative panel with the slots and push it to the left until it clicks into place.

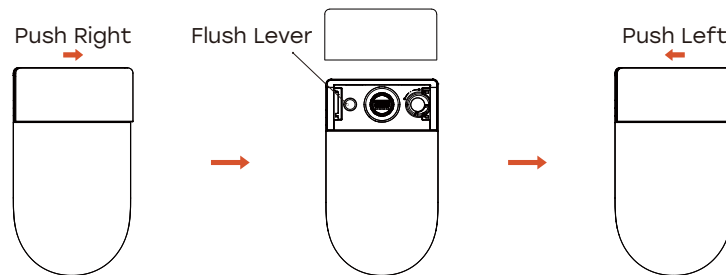

Microwave Induction

Microwave induction, also known as auto open/close lid, uses the microwave induction technology to detect users within a specified range.

The lid will automatically open when a user approaches within this range.

The lid will automatically close when the user leaves for a while and the sensor no longer detects any microwave signal.

- ✘ When this function is disabled, the seat and lid will close automatically after 2 minutes of no user operation.

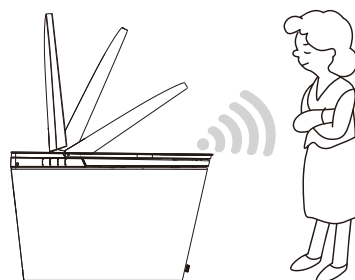





LED Digital Display

When different functions are activated, the corresponding function animation is displayed or the indicator light is on.

The  icon indicates the seat temperature.

The  icon indicates the cleaning water temperature.

The  icon indicates the filter cartridge inspection status. The icon in green indicates the wash function is in progress. The icon in blue indicates the filter cartridge is running properly. The icon in red indicates that the filter cartridge becomes dirty and needs to be replaced.

The  icon in yellow indicates that the auto foam shield function is off. The icon in blue indicates that the auto foam shield function is activated and the foam cleaner in the toilet is sufficient. The icon in red indicates that the foam cleaner is insufficient, reminding the user to refill it.

The  icon indicates that the Do Not Disturb function is activated.

The  icon indicates the auto deodorization function is activated.

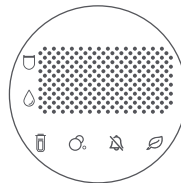

Cleaning Water Filtration

The toilet is equipped with a scale-prevention filter cartridge that filters and blocks sediment, impurities and other contaminants in the water, effectively purifying the cleaning water quality. The filter cartridge status indicator on the LED digital display will turn red and a beeping alarm will sound when the filter cartridge needs to be replaced. If you want purchase it, please contact our Customer Service Team.

When the sound alarm is triggered, press **Stop** on the remote control three times after leaving the seat to stop it.

※ Water quality may vary by region. If the water quality in your area is poor, it is recommended to replace the filter every 3 to 6 months.

Replace Filter Cartridge

Before replacing the filter cartridge, please unplug the toilet and turn off the angle valve to stop water supply.

1. When facing the toilet, press both hands firmly on the decorative panel and push it to the right to remove it.
2. Take out the concealed funnel as shown below, rotate the filter cartridge counterclockwise to remove it, and replace with a new one.
3. Align the decorative panel with the slots and push it to the left until it clicks into place.

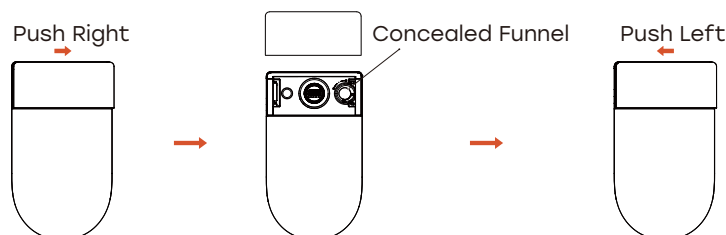



Foam Shield

A foam dispenser is embedded in the back of the toilet, using a dedicated foam cleaner to create a foam shield. The dense foam shield covers the water surface, effectively preventing splashing and isolating unpleasant odors. Additionally, the foam lubricates the toilet wall, preventing waste from sticking and making cleaning more convenient.

Press **Foam Shield** to generate a foam shield immediately. Alternatively, enable the auto foam shield function to let the toilet automatically create a foam shield when the seat is occupied or when a male user urinates with the seat and lid open.

Foam Cleaner Filling

The toilet needs to add foam cleaner for the first use. The foam cleaner is not included in the product package and must be purchased separately. If you want to purchase it, please contact our Customer Service Team. Additionally, the auto foam shield function is disabled by default. To enable it, please refer to the instructions in **Other Settings**.

- ✘ Before filling the foam cleaner, please unplug the toilet. Once the foam cleaner is added, reconnect the toilet to the power supply.
- 1. When facing the toilet, press both hands firmly on the decorative panel and push it to the right to remove it.
- 2. Pour the foam cleaner into the dispenser through the filling port.
- 3. Align the decorative panel with the slots and push it to the left until it clicks into place.
- 4. If no foam is released when pressing **Foam Shield**, or when the seat is occupied with the auto foam shield function enabled, it indicates that the foam cleaner is empty and needs to be refilled. Please follow the steps above to refill it.
- ✘ Please use customized foam cleaner. Otherwise, it may cause clogging and damage to internal components.
- ✘ When filling the foam cleaner or performing maintenance, be careful not to let sediment and other impurities fall into the filling port.
- ✘ During refilling, add no more than one bottle of our dedicated foam cleaner at a time.
- ✘ When using the foam shield function for the first time, the toilet needs about 30 seconds to draw in the foam cleaner liquid before foam is generated. Please wait patiently and do not press **Stop** on the remote control, press the side button or start a flush during this process. If the foam cleaner pumping process is interrupted accidentally, you can restart it by following the instructions in **Settings Mode**.

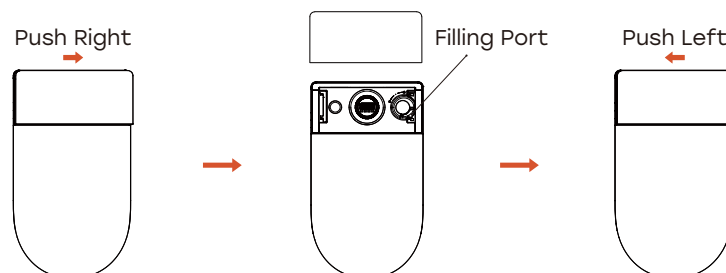

**Auto Deodorization**

The deodorization function will be activated automatically when the seat is occupied and will be turned off 3 minutes after the seat is unoccupied.

A deodorizer cartridge and a fan are installed at the back of the toilet to help avoid unpleasant odors and improve ventilation.

**UV Nozzle Purification**

An ultraviolet lamp is installed and concealed inside the smart toilet.

Ultraviolet rays purify the nozzle surface. UV nozzle purification will start automatically 10 seconds after the seat is unoccupied and it will work for 3 minutes.

Pressing **Stop** or activating the seat sensor will stop the UV nozzle purification process.

※ Please be assured that this function is completely safe and does not pose any risk to the human body.

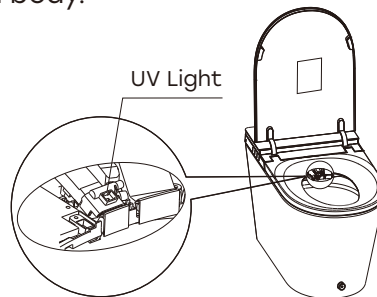

**UVC Water Purification**

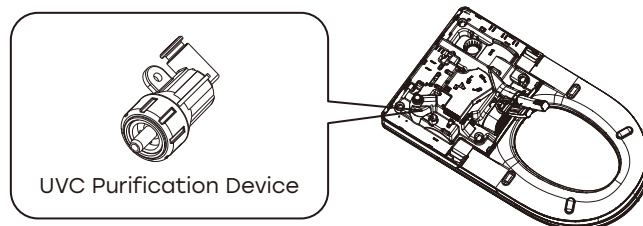
The cleaning water supply line of the smart toilet has a section of UVC purification device that emits the ultraviolet rays to purify the cleaning water passing through. Therefore, the cleaning water is purified efficiently whenever any wash function is activated.



+ Electrolyzed Water Purification

Electrolyzed water is automatically generated to moisten the toilet bowl, providing a purifying effect that helps effectively clean the ceramic inner surface.

Pressing **Stop** on the remote control or the side button  |  on the toilet will stop the electrolyzed water purification process.

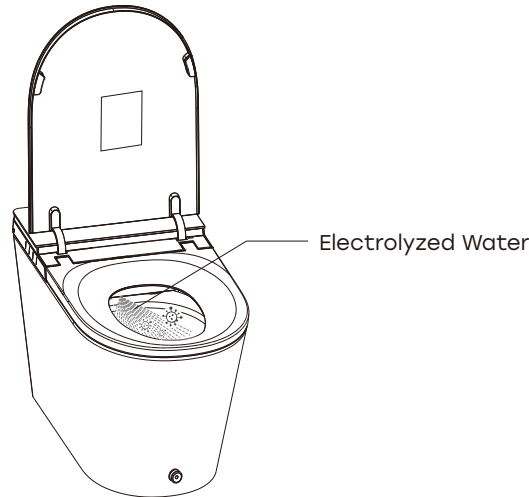
**+ User-friendly Design**

- ① **Pre-wet**
When the toilet seat is occupied, the product will flush automatically once towards the seat to moisten the toilet bowl.
- ② **Multiple Protections**
Multiple built-in safety features are designed to protect both the user and the product.
- ③ **Memory Mode**
The toilet automatically remembers and retains the last-used settings, including water temperature, seat temperature, warm air temperature, nozzle position and other user preferences. The water temperature, seat temperature and warm air temperature settings are preserved even in the event of a power failure.
- ④ **Hygienic Seat**
The seat is made of hygienic material to ensure enhanced hygiene.
- ⑤ **Energy-saving Mode**
When enabled, the toilet conserves energy by maintaining the heated seat temperature at 86 °F when not in use.
- ⑥ **Four Seasons Temperature Sensing**
When enabled, the water temperature, seat temperature and warm air temperature will be adjusted automatically based on the ambient temperature.

Note:

The energy-saving mode and the four seasons temperature sensing function are mutually exclusive. If both are enabled at the same time, the most recently set one will take effect.

Kick Control Operations

+

The toilet is equipped with a kick control in front of the toilet to control the open and close of the lid and the seat as well as the kick flush when the lid is closed.

Tap the **Kick Control** with your foot to raise your toilet lid/seat.

Tap the kick button once: Lid opens.

Tap the kick button twice: Seat raises.

Tap the kick button three times: Seat and lid will close and the toilet will flush immediately.

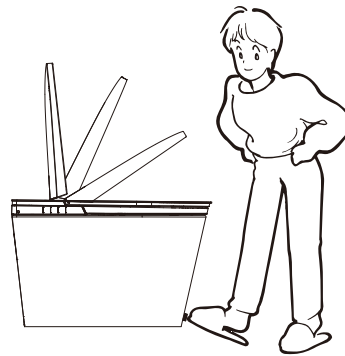

※ It is a dual flush toilet. Pressing and holding **Flush** on the remote control triggers only a half flush, while all other flush operations perform a full flush.

Side Button Operations



Power/Stop

When the toilet is powered on and no one is seated, press and hold this side button for 3 seconds to enter the standby mode.

When the toilet is in standby mode, press and hold this side button for 3 seconds to activate it.

When the toilet is in feminine/posterior wash or drying mode, press this side button to stop the function.

When the toilet is in wash mode or when the seat is occupied but no function is running, press and hold this side button for 3 seconds to turn on the dryer. When the toilet is in drying mode, press and hold this side button for 3 seconds to regulate the warm air speed.

When the toilet is not in use, press this side button to immediately flush the toilet.

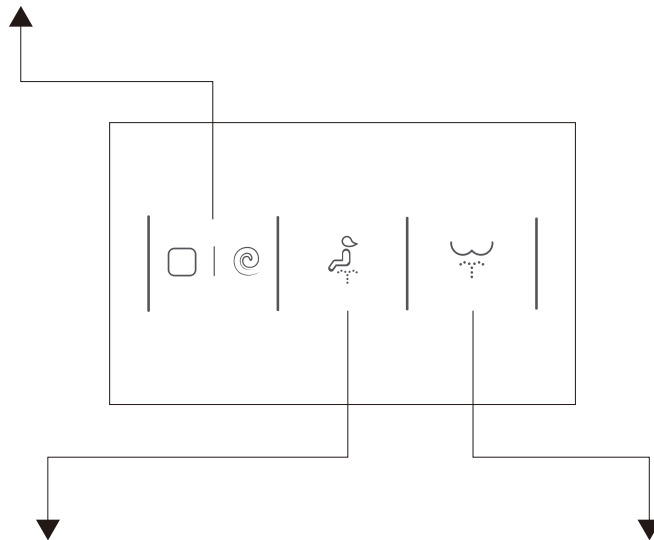

Feminine

When the seat is occupied and the toilet is not in wash or drying mode, press this side button to start the smart wash cycle. Movement wash is provided by default.

The entire process includes feminine wash, auto flush and warm air drying, taking approximately 5.5 minutes.

When the toilet is in feminine wash, press this side button to regulate the cleaning water pressure.

Posterior

When the seat is occupied and the toilet is not in wash or drying mode, press this side button to start the smart wash cycle. Movement wash is provided by default.

The entire process includes posterior wash, auto flush and warm air drying, taking approximately 5.5 minutes.

When the toilet is in posterior wash, press this side button to regulate the cleaning water pressure.

Remote Control Operations

- ✘ The remote control panel consists of a mechanical button area and a touch-sensitive area. Press any function button within the touch-sensing area to activate the display panel.
- ✘ The touch-sensing area is covered with a protective film. For optimal touch sensitivity, please remove the protective film before use.

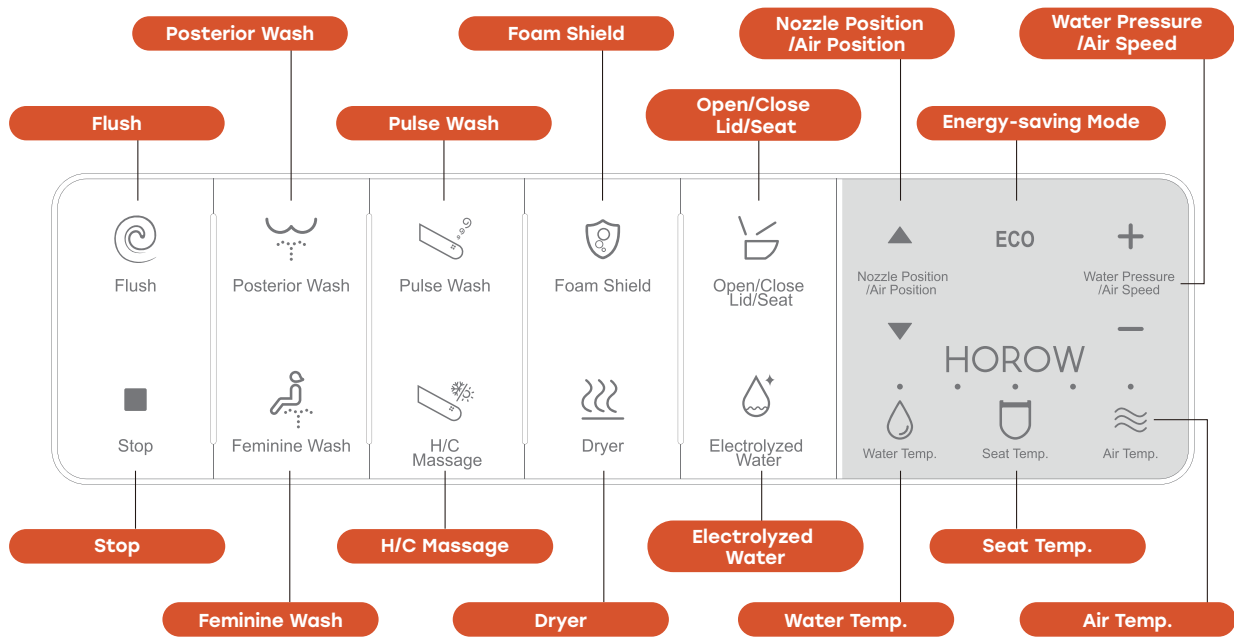

Press **Flush** to start a full flush after use.

Press and hold **Flush** for 3 seconds to start a half flush after use.

Press **Stop** to stop such activated functions as posterior wash, feminine wash, warm air drying, auto deodorization and UV nozzle purification.

Press **Posterior Wash** to start posterior cleaning while seated. Movement wash is provided by default. Press again to stop movement wash and return to posterior wash. It will stop after approximately 3 minutes.

Press **Feminine Wash** to start feminine cleaning while seated. Movement wash is provided by default. Press again to stop movement wash and return to feminine wash. It will stop after approximately 3 minutes.

Press **Pulse Wash** to start pulse cleaning while seated. Press again to start movement wash. Press the third time to stop movement wash and return to pulse wash. It will stop after approximately 3 minutes.

Press **H/C Massage** to switch between warm and cold water washing during any wash process.

Press and hold **H/C Massage** for 3 seconds to pre-wet the toilet bowl immediately.

Press **Foam Shield** to start to generate a foam shield immediately.

Press **Dryer** to dry off the water after using the wash function. Movement drying is provided by default. Press again to stop movement drying and return to regular drying. It will stop after approximately 4 minutes.

Press and hold **Dryer** for 3 seconds to start a UV nozzle purification process for the nozzle when the lid is closed.

Press **Open/Close Lid/Seat** to remotely control auto open/close of the lid and seat.

Press **Electrolyzed Water** to close the lid automatically and perform one cycle of electrolyzed water purification.

Press **ECO** to enable/disable the energy-saving mode. (A short beep indicates that the function has been enabled, while 2 short beeps indicate that the function has been disabled.)

※ When enabled, the toilet conserves energy by maintaining the heated seat temperature at 86 °F when not in use. Once seated, the seat returns to the preset temperature.

Press **Nozzle Position/Air Position** to adjust the nozzle position during any wash process and adjust the warm air position during drying.

Press and hold **Nozzle Position/Air Position** ▲ for 3 seconds to extend the nozzle out while unseated, and the water will flow out for 1 minute, allowing the user to easily detach and clean it manually.

※ The nozzle will automatically clean itself before and after any wash function.

Press **Water Pressure/Air Speed** to adjust the cleaning intensity during any wash process and adjust the warm air speed during drying.

Press **Water Temp.** to adjust the water temperature for any wash function. Six temperature levels are available: Off (room temp.), Level 1 (91 °F), Level 2 (95 °F), Level 3 (99 °F), Level 4 (100 °F) and Level 5 (102 °F). At each temperature level, corresponding level lights on the remote control will illuminate. For example, at Level 1, the No. 1 level light (counting from left to right) will illuminate, at Level 2, the No.1 and No. 2 level lights will illuminate, and so on.

Press **Seat Temp.** to adjust the heated seat temperature. Six temperature levels are available: Off (room temp.), Level 1 (91 °F), Level 2 (95 °F), Level 3 (99 °F), Level 4 (100 °F) and Level 5 (102 °F). At each temperature level, corresponding level lights on the remote control will illuminate.

Press **Air Temp.** to adjust the warm air temperature of the dryer during drying. Six temperature levels are available: Off (room temp.), Level 1 (95 °F), Level 2 (100 °F), Level 3 (105 °F), Level 4 (111 °F) and Level 5 (118 °F). At each temperature level, corresponding level lights on the remote control will illuminate.

• Other Settings

Note: When adjusting the following settings, a short beep indicates that the function has been enabled, while 2 short beeps indicate that the function has been disabled.

Press and hold **Posterior Wash** for 3 seconds to enable/disable the prolonged sitting reminder function. The function is disabled by default.

※ When enabled, if the user remains seated on the toilet seat for more than 15 minutes without using the wash or warm air drying function, the toilet will automatically emit a long beep every minute to remind the user and prevent low-temperature burns.

Press and hold **Feminine Wash** for 3 seconds when the lid is open and the seat is closed to enable/disable the child wash mode. The mode is disabled by default. In this mode, posterior wash, feminine wash and drying functions can be used without occupying the seat. The toilet will automatically exit child wash mode under any of the following conditions: manually closing the lid, manually opening the seat, flushing via the remote control or side button, or no operation for 30 minutes.

※ In this mode, the seat temperature, water temperature, air temperature, and water pressure are set to Level 3, while the air speed is switched to Level 1. The nozzle position is set to the most forward position for all wash functions. These settings can be adjusted manually during use.

※ In this mode, the lid and the seat cannot be opened or closed by the remote control or the kick control.

※ Since cleaning functions are not restricted by seat occupancy detection, water splashing may occur. Please supervise children to prevent unintended use or play.

Press and hold **Pulse Wash** for 3 seconds to set the corresponding color of the ambient light. There are six color modes in total, and each press will switch to the next color in the following sequence: cyan, orange, white, blue, rhythmic (ambient light synchronizes with surrounding music, creating a dynamic and relaxing atmosphere) and off.

Press and hold **Foam Shield** for 3 seconds to enable/disable the auto foam shield function.
 ※ When enabled, the toilet will automatically create a foam shield over water surface in the bowl whenever the seat sensor detects a user or when a male user urinates with the seat and lid open.

Press and hold **Open/Close Lid/Seat** for 3 seconds to enable/disable the Do Not Disturb function. The function is disabled by default.
 ※ When enabled, no audio prompts will be heard during side button and remote control operations.

Press and hold **Electrolyzed Water** for 3 seconds to enable/disable the auto electrolyzed water function.
 ※ When enabled, after the seat is unoccupied and the lid has been closed for 90 seconds, or at intervals of approximately eight hours, electrolyzed water is automatically generated to atomize and moisten the toilet bowl.

Press and hold **ECO** for 3 seconds to enable/disable the night light function. The night light function is enabled by default.
 ※ When enabled, the night light will illuminate if the toilet lid is open. The night light will be off automatically if the toilet lid is closed.

Press and hold **Water Pressure/Air Speed +** for 3 seconds to enable/disable the strong and weak massage function during posterior wash or feminine wash.
 ※ When enabled, the cleaning intensity switches between strong and weak during the wash process.

Press and hold **Seat Temp.** for 3 seconds to enable/disable the four seasons temperature sensing function. The function is disabled by default.
 ※ When enabled, the water temperature, seat temperature and warm air temperature will be adjusted automatically based on the ambient temperature. During seat occupancy, if the water temperature, seat temperature or warm air temperature is adjusted via the remote control, the corresponding temperature will exit four seasons temperature sensing setting, while others remain their settings. After leaving the seat, the four seasons temperature sensing will automatically resume. The temperature adjustment via the remote control will be ineffective while unseated. The four seasons temperature sensing settings are listed below.

Ambient Temp. (°F)	Seat Temp.	Water Temp.	Air Temp.
$T \geq 86$	Off	Level 1	Level 1
$77 \leq T < 86$	Off	Level 3	Level 1
$59 \leq T < 77$	Level 1	Level 3	Level 3
$50 \leq T < 59$	Level 3	Level 5	Level 5
$T < 50$	Level 5	Level 5	Level 5

Press and hold **Open/Close Lid/Seat** and **Pulse Wash** simultaneously for 3 seconds to enable/disable the pre-wet function.

Press and hold **Open/Close Lid/Seat** and **Feminine Wash** simultaneously for 3 seconds to enable/disable the auto flush function.

Press and hold **Open/Close Lid/Seat** and **Dryer** simultaneously for 3 seconds to enable /disable the drying flush function.

※ When disabled, the drying flush will not be performed. As for the smart wash circle, only posterior/feminine wash and warm air drying will be executed.

Press and hold **Open/Close Lid/Seat** and **Posterior Wash** simultaneously for 3 seconds to enable/disable the auto deodorization function and regulate the auto deodorization fan speed. There are three levels in total: Off (auto deodorization disabled), Level 1 and Level 2. Auto deodorization is enabled and the fan speed is set at Level 1 by default. Each press will adjust the setting in the following sequence: Level 1 – Level 2 – Off – Level 1, cycling continuously.

Press and hold **Open/Close Lid/Seat** and **Foam Shield** simultaneously for 3 seconds to enable/disable the microwave induction function (auto open/close lid) and regulate the distance level of microwave induction. Auto open/close lid is enabled and the distance for auto open/close is set at Level 2 by default. Each press will adjust the setting in the following sequence: Level 2 – Level 1 – Off – Level 3 – Level 2, cycling continuously.

Level Position	Distance for Auto Open/Close (in)	Long Beeps
Level 1	31-1/2	1
Level 2	39-3/8	2
Level 3	47-1/4	3

Note:

The microwave induction distance for the auto open/close lid described above refers to the distance between the user and the front edge of the toilet seat.

• **Settings Mode**

If entering this mode, the remote control can be used to enable or disable the automatic functions of the toilet as described below.

Press and hold **Flush** and **Open/Close Lid/Seat** simultaneously for 3 seconds until a long beep is heard to enter the Settings Mode.

Note: Some automatic functions are enabled by default from the factory, while others are disabled. To make adjustments, please enter into the Settings Mode to enable or disable these functions.

A short beep indicates that the function has been enabled, while 2 short beeps indicate that the function has been disabled.

Press and hold **ECO** for 3 seconds to enable/disable the LED digital display.

※ When enabled, both the LED digital display and the ambient light are turned on. When disabled, both the LED digital display and the ambient light are turned off.

Press **Seat Temp.** to enable/disable the smart night light function. The smart night light function is effective only when the night light function is enabled. (Both the smart night light and the night light function are enabled by default.)

※ When enabled, the night light will illuminate automatically when the toilet lid is open if the room is dark. The night light will be off automatically when the room is bright or the toilet lid is closed. In this case, if the night light is off automatically, the remote control cannot be used to turn on the night light manually.

Press **Water Temp.** to enable/disable the UVC water purification function.

Press **Feminine Wash** to enable/disable the UV nozzle purification function.

Press **Posterior Wash** to enable/disable the men's priority mode. The function is disabled by default.

- ※ When enabled, a simple foot kick on the kick control will open both the lid and the seat if they are closed.

Press **Foam Shield** to enable/disable the foam cleaner shortage reminder.

Press and hold **Foam Shield** for 3 seconds to start foam cleaner pumping, which runs for about 30 seconds to generate foam. (Note: This operation is required only when the pumping process is interrupted and no foam is generated.)

Press **Open/Close Lid/Seat** to adjust the time interval for auto lid close and flush after leaving the seat. The default setting is Level 2. Each press will adjust the time interval in the following sequence: Level 2 – Level 3 – Level 1 – Level 2, cycling continuously.

- ※ Level 1 (1 beep): The lid closes and the toilet flushes 5 seconds after the user leaves the seat.
- ※ Level 2 (2 beeps): The lid closes and the toilet flushes 10 seconds after the user leaves the seat.
- ※ Level 3 (3 beeps): The lid closes and the toilet flushes 15 seconds after the user leaves the seat.

After the settings needed are completed, press and hold **Flush** and **Open/Close Lid/Seat** simultaneously for 3 seconds until 3 short beeps are heard to save the settings and exit the Settings Mode.

If no operation is done within 1 minute after entering Settings Mode, the mode will automatically exit with 3 short beeps.

Code Pairing of Remote Control

The remote control is pre-paired with the smart toilet at the factory for immediate use. However, if the remote control isn't functioning properly, or if you own multiple toilets of the same brand and experience interference when operating them, you can manually pair the remote control with the toilet.

+ Unplug the toilet. Press and hold **Stop** for a few seconds until all the level lights flicker.

Press and hold the **Stop** button



The level lights are flickering

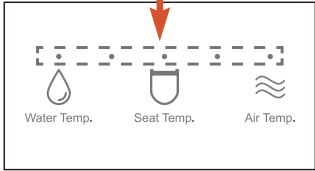

Place the remote control near the product and plug the attaching plug.

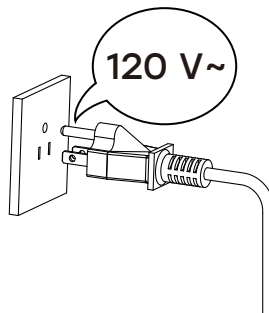

The level lights stop flickering, and then they are lighted on. Codes are paired successfully when all lights are on.

All the level lights are normally on

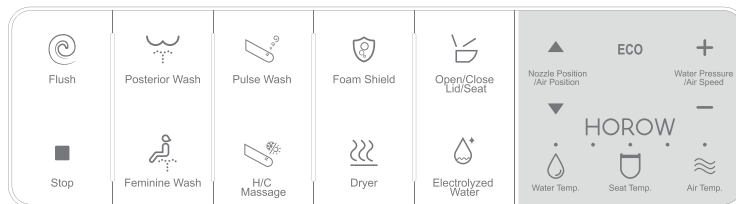

Daily Maintenance

Regular maintenance is required to ensure normal use.

+**Note:**

1. Cut off the power and water supply before maintenance.
2. Direct water wash to the entire product is prohibited.

+**Warning:**

Do not spray water or detergents on the toilet, remote control or the power cord. Doing so may cause electric shock or fire.

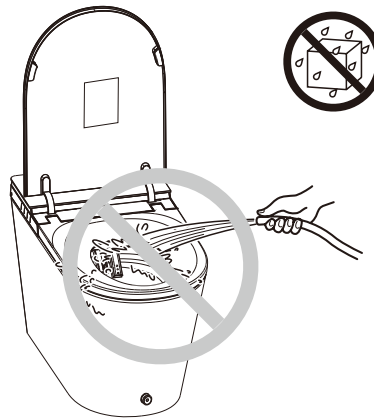

Maintenance of Ceramics, Seat and Lid

+

1. Wipe dust or stains with a soft wet cloth.
2. A wet soft brush, cloth, or sponge may be used to clean the ceramic area.

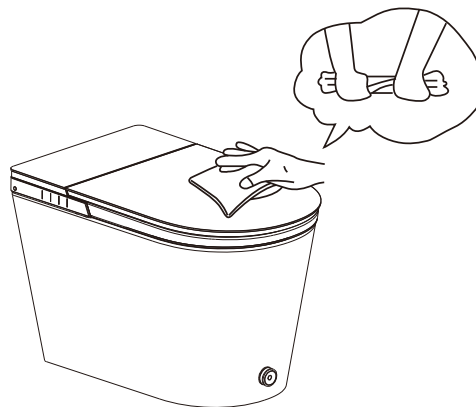

※ Do not use abrasive cleaners, such as alcohol, bleach, painter thinner, cresol, benzene, gasoline, etc.

Maintenance of the Nozzle

+

Press and hold **Nozzle Position/Air Position ▲** button on the remote control without occupying the seat when the toilet is powered on. The nozzle will extend out and the water will flow out for 1 minute. Proceed to clean it with a soft toothbrush. The nozzle can be disassembled to clean.

Press and hold **Nozzle Position/Air Position ▲** button again, and the nozzle will return to the original position. In addition, you can press **Stop** on the remote control or the side button  on the toilet to retract the nozzle.

Nozzle Removal: Hook your fingers into the groove on the back of the nozzle and pull down firmly to remove it.

Nozzle Installation: Align the nozzle with its original position and press firmly until it is securely in place.

- ※ Do not forcefully hold the nozzle, otherwise it may break.
- ※ Please replace the nozzle with a new one if it is clogged.

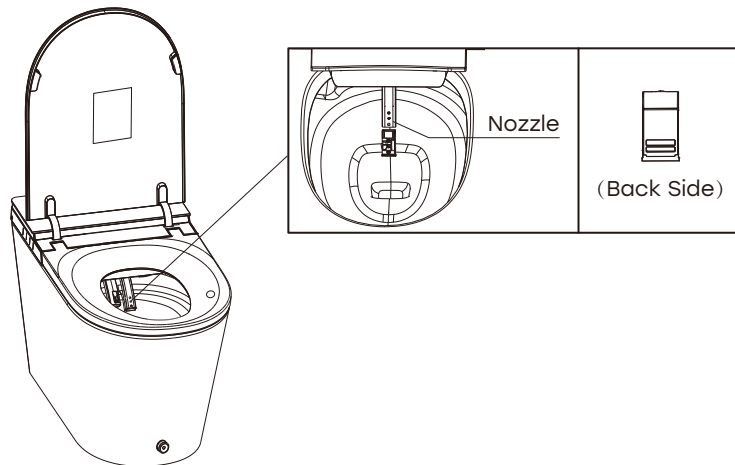

Maintenance During Winter Season

During the winter season, the water inside may freeze after long periods of storage and non-use. Please take measures to prevent.

+

Note:

1. Before connecting the product to the water supply and electrical outlet, allow it to defrost for 30 minutes in a warm indoor environment.
2. In cases of extreme cold/freezing/nozzle stuck in place, wrap the water input line with a warm towel. Never pour hot water or use a hot dryer directly on the toilet.

Troubleshooting

This Troubleshooting Guide is for general aid only. If the user encounters any problems, please first consult the troubleshooting guide below. If the problem persists, please contact our Customer Service Team.



Scan the QR code for video resources and find the troubleshooting videos you need.

Power Button		
Phenomenon	Fault Diagnoses	Solutions
Not working	Check whether the attaching plug is loose or not	Please check the circuit
	Check whether the power is switching on or off (the power light is not on)	Press and hold the side button  , the power light is on
	Check whether there is any electric leakage or not	Unplug the attaching plug from the socket, plug it again later, if it is still not working, please unplug the attaching plug and contact our Customer Service Team
Wash Functions		
Phenomenon	Fault Diagnoses	Solutions
No water from the spout	Check whether the water supply cuts off or not	Wait for the water supply restoring
	Check whether the angle valve switches off or not	Open the angle valve
	Check whether the water filter is blocked or not	Change the water filter
	Check whether the inlet pipe is flexed or not	The inlet pipe must be straight
The intensity of cleaning is not strong enough	Check whether the water pressure of cleaning switches to low level or not	Regulate the water pressure according to the Installation & User Manual
	Check whether the inlet filter is blocked or not	Change the water filter
Unusual water flow from the spout	Abnormal operation	Unplug the attaching plug for one minute and then plug it again
The water temperature is not warm enough	Check whether the water temperature switches to low level or not	Regulate the water temperature according to the Installation & User Manual
The cleansing is always leaking	Solenoid valve no longer has any effect	Please contact our Customer Service Team
The cleaning function is not working normally	The human induction system of the toilet seat no longer has any effect	Please contact our Customer Service Team

Dryer

Phenomenon	Fault Diagnoses	Solutions
The dryer blows cold air	Check whether the dryer switches off or not	Regulate the temperature of dryer according to the Installation & User Manual
	Check whether the heating element of dryer is damaged or not	Please contact our Customer Service Team

Heated Seat

Phenomenon	Fault Diagnoses	Solutions
The seat temperature is too low or is not hot	Check whether the temperature of toilet seat is on the OFF position or not	Regulate the temperature of toilet seat according to the Installation & User Manual

Remote Control

Phenomenon	Fault Diagnoses	Solutions
The light of water temperature is flickered	Low battery	Please replace a new battery
Remote control is not working	Check whether there is any water on the remote control or not	Wipe off water by dry towel
Water temperature, seat temperature and warm air temperature cannot be adjusted while unseated	Check whether the four seasons temperature sensing function is enabled	Disable the four seasons temperature sensing function and adjust the temperature again

Toilet Bowl

Phenomenon	Fault Diagnoses	Solutions
The toilet does not flush cleanly	No power supply	Power restoration
	No water from the spout	Please contact our Customer Service Team
	No water but have the sound of flushing	Check whether the pipeline is blended or not, please keep the water supply pipeline open and smooth
	Have water all the time	Please contact our Customer Service Team if there is any unusual with the water inlet valve

Specifications

Product Model		HOROW X70
Product Dimensions		28-3/16" (L) * 15-15/16" (W) * 17-15/16" (H)
Product Weight (lb.)		104 lb
Rough In Size		12"
Seat Height		17"
Bowl/Seat Shape		Elongated
Flush Type		Tornado flush
Gallons Per Flush (US gallon)		Dual Flush: 1.0/1.28
Installation Type		Floor-mount
Rated Voltage		120 V~
Rated Frequency		60 Hz
Rated Power		820 W (When inlet water temperature is 59 °F)
Power Cord Length		35-7/16"
Water Supply Type		G3/4
Water Inlet	Inlet Water Temperature	33.8 °F ~ 95 °F
	Minimum Pressure	8.7 psi, ensuring a flow of water at least 2.74 GPM
	Maximum Pressure	116 psi (static state)
Cleaning	Way for Heating	Instant heating
	Temperature of Warm Water	Off/about 91.4 °F ~ 102.2 °F (6 levels)
	Safety Devices	Thermostat series, thermal fuse, flow detection device
Dryer	Warm Air Temperature	Off/about 95 °F ~ 118.4 °F (6 levels)
	Warm Air Speed	Above 14 m/s
	Safety Devices	Bimetal thermostat series, thermal fuse
Heated Seat	Seat Temperature	Off/about 91.4 °F ~ 102.2 °F (6 levels)
	Safety Devices	Thermal fuse, temperature sensor
Remote Control Battery		Two AAA batteries

Warranty

ONE YEAR LIMITED WARRANTY

HOROW products are made with high-quality materials and workmanship to provide customers with products that are built to last. If any defects in material or workmanship are detected during normal use within the first year of purchase, such as the replacement of any product or product part that you consider to be defective, HOROW will provide replacement parts free of charge. We are **not responsible** for all damages that result from **improper installation resulting in unavailability, repair and maintenance**. This warranty applies only to the original purchaser. Proof of purchase and **evidence of damage** will be required in the case of a **claim**.

HOROW recommends the installations to be made by a licensed, professional plumber.

HOROW will not be held responsible for any damage or product failure due to improper installation, misuse, or failure to use a licensed professional. HOROW is not responsible for any removal or installation cost.

This One Year Limited Warranty will be voided if:

The installation recommendations were not followed.

The product has been moved from its initial place of installation.

The product has been modified.

The product has been subjected to improper maintenance, abuse, misuse, excessive use of chemicals, accident or other damages.

HOROW makes no implication that products comply with any or all local building or plumbing codes. It is the consumer's responsibility to determine local code compliance. This warranty extends to the original purchaser and first consumer.

HOROW is not liable for any incidental, consequential or special damages associated with the return, replacement, installation or use of your product. This includes freight costs, labor, travel time, lost profit, home damages and other contingent liabilities and costs (including, without limitation, costs associated with experts, investigations, analyses, attorneys and other professionals and services).

The HOROW warranty is a comprehensive and explicit limit of liability, and all items outside of it are not addressable by or the responsibility of HOROW. Certain states have variances regarding implied warranties and in those situations, we remain fully compliant.

Warranty Registration

Proof of purchase is required to validate this limited warranty. HOROW encourages you to register your product upon purchase to create a record of ownership at www.horow.com. Registration is voluntary and not required to maintain your limited warranty rights.



For any questions or claims, please contact us by phone or email.

Phone: (+1)209-200-8033

Monday to Friday

Email: support@horow.com

When making a claim, please prepare a photo of the evidence of damage so that we can quickly resolve the claim for you.



Warning

Content may contain sharp and other possibly harmful pieces and may cause hazard to children and adults, HOROW is not responsible in any way for personal damage.