

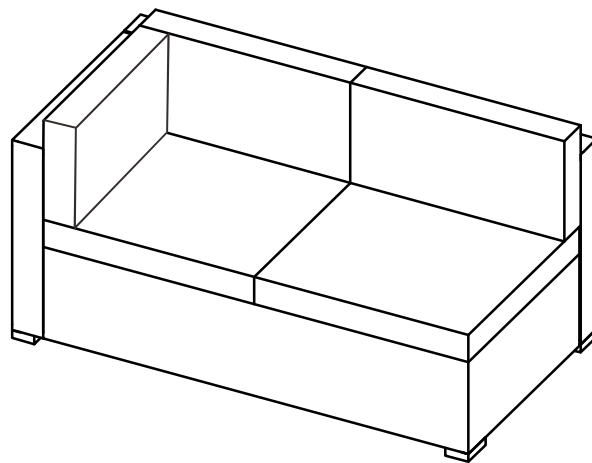

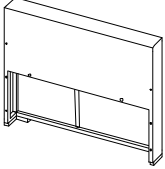

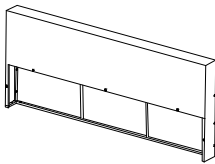

## Outdoor Wicker Corner Loveseat with Interchangeable Arm

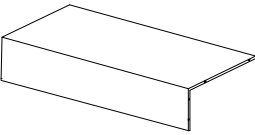
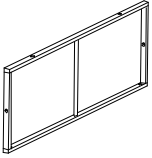





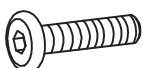
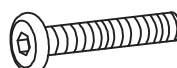
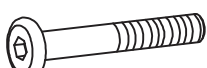

# PART LIST

				
<p>Interchangeable Arm Panel 1 PC</p>	<p>Back Panel 1 PC</p>	<p>Seat Panel 1 PC</p>	<p>Side Panel 1 PC</p>	<p>Cover of Seat Cushion * 2 PCS</p>
				
<p>Core of Seat Cushion 2 PCS</p>	<p>Cover of Back Cushion * 2 PCS</p>	<p>Core of Back Cushion 2 PCS</p>	<p>Cover of Side Cushion * 1 PC</p>	<p>Core of Side Cushion 1 PC</p>

\*Please note cushion covers will ship separately.

# HARDWARE LIST

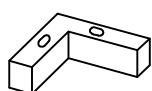
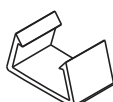
 <p>M6*30mm</p>	 <p>M6*35mm</p>	 <p>M6*50mm</p>	 <p>M6mm</p>	 <p>D 18mm</p>
<p>Short Bolt 3 PCS</p>	<p>Medium Bolt 4 PCS</p>	<p>Long Bolt 11 PCS</p>	<p>Nut 15 PCS</p>	<p>Washer 25PCS</p>
 <p>D 12mm</p>	 <p>M6mm</p>	 <p>M6mm</p>		
<p>Small Washer 4 PCS</p>	<p>Wrench 1 PC</p>	<p>Allen Key 1 PC</p>	<p>L Foot 2 PCS</p>	<p>Plastic Clip 2 PCS</p>

# EXTRA HARDWARE LIST

<div data-bbox="81 152 140 208" data-label="Text">#1</div> <div data-bbox="153 241 296 311" data-label="Image"> </div> <div data-bbox="140 344 314 385" data-label="Text">M6*30mm</div>	<div data-bbox="359 152 418 208" data-label="Text">#2</div> <div data-bbox="410 241 588 311" data-label="Image"> </div> <div data-bbox="410 344 584 385" data-label="Text">M6*35mm</div>	<div data-bbox="635 152 694 208" data-label="Text">#3</div> <div data-bbox="678 241 884 311" data-label="Image"> </div> <div data-bbox="684 344 858 385" data-label="Text">M6*50mm</div>	<div data-bbox="911 152 970 208" data-label="Text">#4</div> <div data-bbox="1002 241 1091 320" data-label="Image"> </div> <div data-bbox="992 344 1115 385" data-label="Text">M6mm</div>	<div data-bbox="1187 152 1246 208" data-label="Text">#5</div> <div data-bbox="1273 241 1378 311" data-label="Image"> </div> <div data-bbox="1257 344 1406 385" data-label="Text">D 18mm</div>
<div data-bbox="137 405 309 483" data-label="Text">Short Bolt 1 PC</div>	<div data-bbox="387 405 601 483" data-label="Text">Medium Bolt 1 PC</div>	<div data-bbox="694 405 861 483" data-label="Text">Long Bolt 1 PC</div>	<div data-bbox="1003 405 1091 483" data-label="Text">Nut 1 PC</div>	<div data-bbox="1252 405 1396 483" data-label="Text">Washer 1 PC</div>
<div data-bbox="81 504 140 560" data-label="Text">#6</div> <div data-bbox="172 595 255 647" data-label="Image"> </div> <div data-bbox="156 685 293 725" data-label="Text">D 12mm</div> <div data-bbox="97 750 344 837" data-label="Text">Small Washer 1 PC</div>				

Step 1. Lay back panel (part B) down on a soft flat surface, such as carpet, as shown below. Attach interchangeable arm panel (part A) to left or right side (depending on preference ) of back panel (part B) using long bolts(part #3),washers(part #5),nuts (part #4),wrench(part #7) and allen key (part #8).

NOTE:Please do not fully tighten bolts until unit is fully assembled.

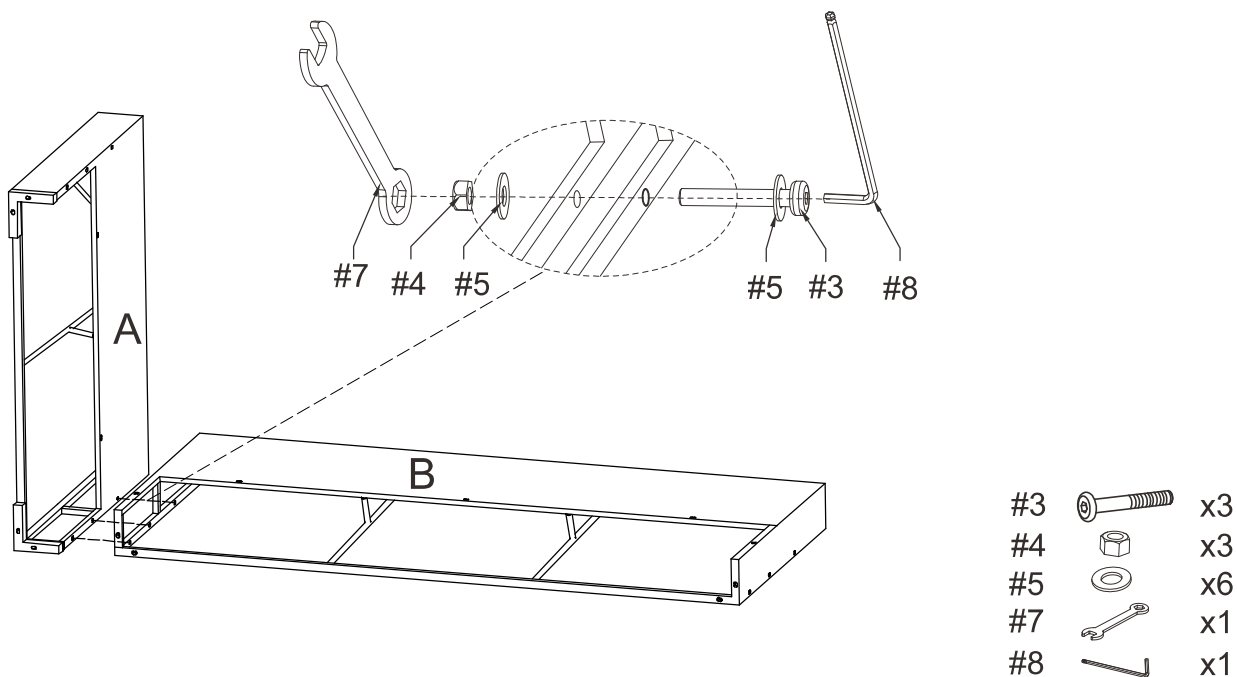

Step 2. Attach seat panel (part C) to assembled unit (parts A&B) using long bolts (part #3), washers (part #5) ,nuts (part #4),wrench (part #7) and allen key (part #8).

NOTE:Please do not fully tighten bolts until unit is fully assembled.

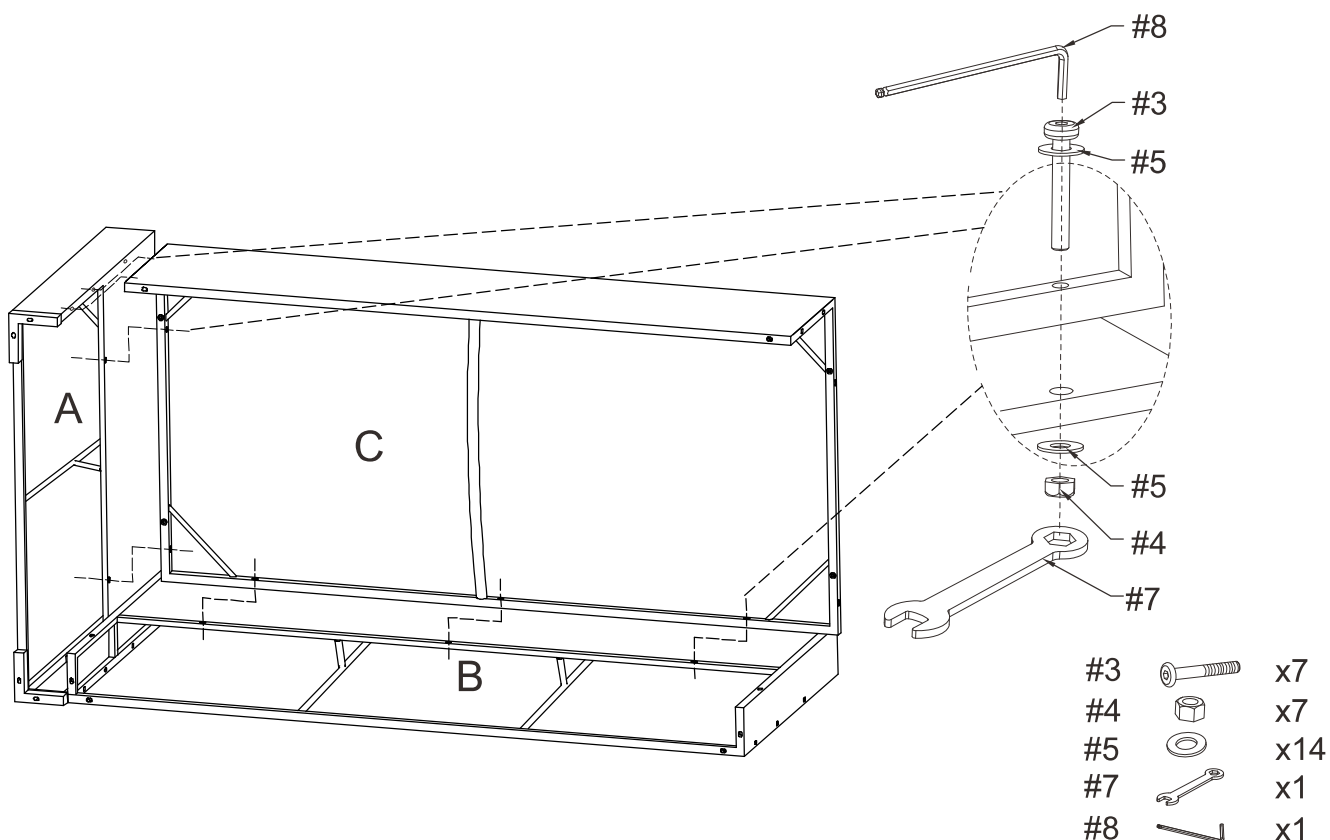

Step 3. Attach side panel (part D) to back panel (part B) and seat panel (part C) using short bolts (part #1), long bolt (part #3), washers (part #5), nuts (part #4), wrench (part #7) and allen key (part #8).

NOTE: Please do not fully tighten bolts until unit is fully assembled.

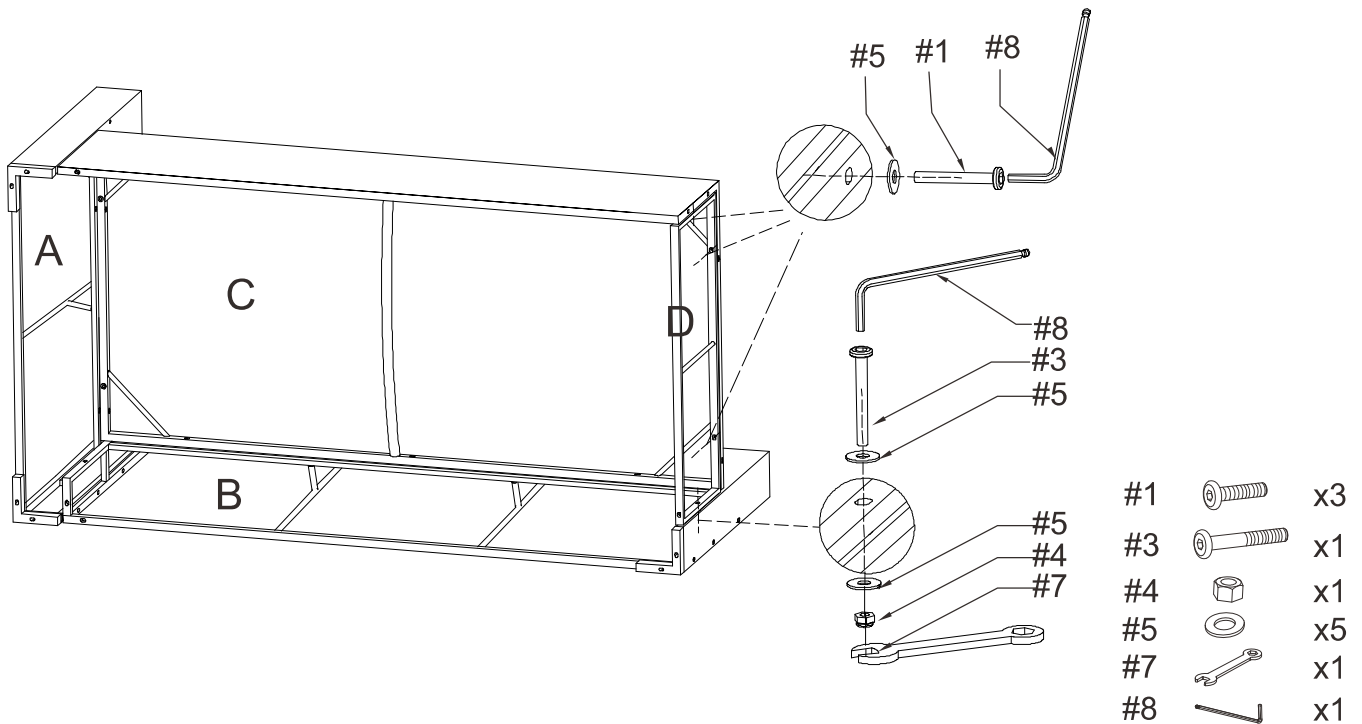

Step 4. Attach L foot (part #9) to assembled unit (parts B,C&D) using medium bolts (part #2) small washers (part #6), nuts (part #4), wrench (part #7) and allen key (part #8).

NOTE: Please fully tighten all bolts at this time.

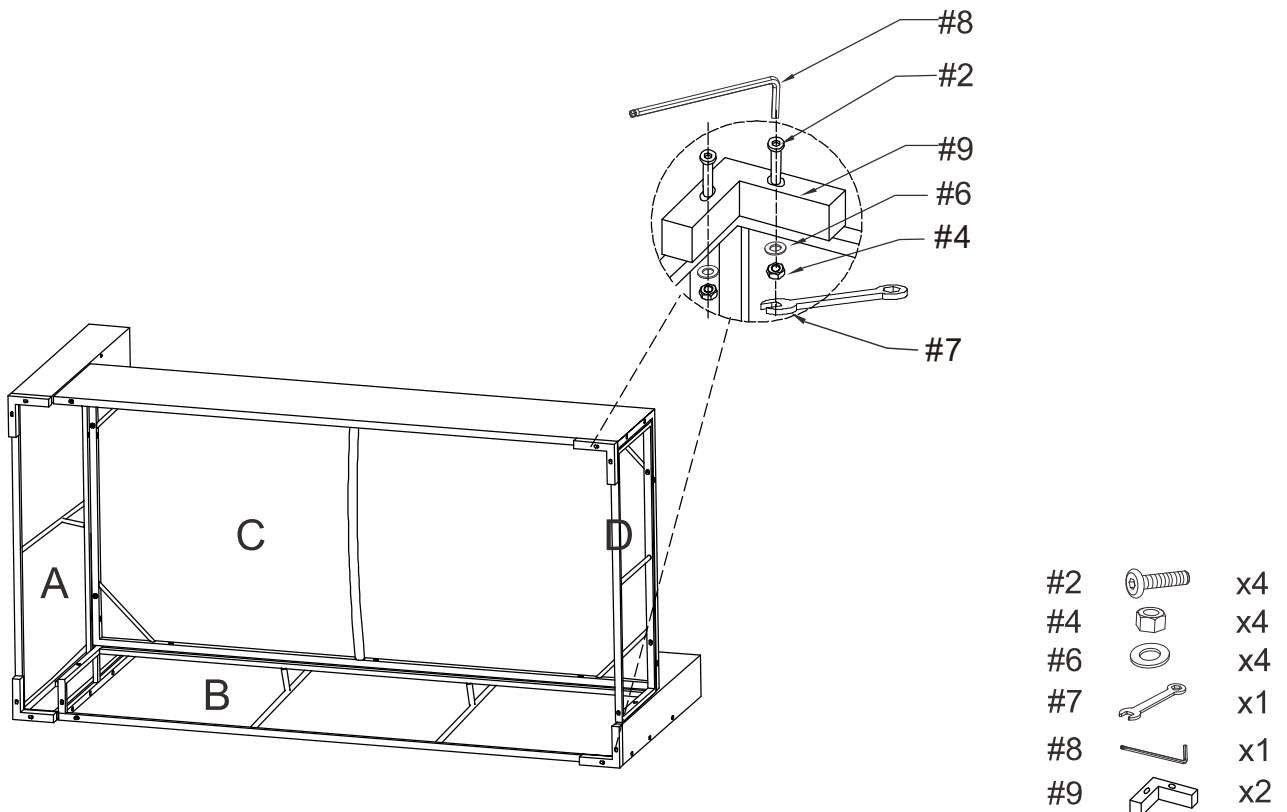

Step 5. Insert core of seat cushion (part F) into cover of seat cushion (part E).  
Insert core of back cushion (part H) into cover of back cushion (part G).  
Insert core of side cushion (part J) into cover of side cushion (part I).

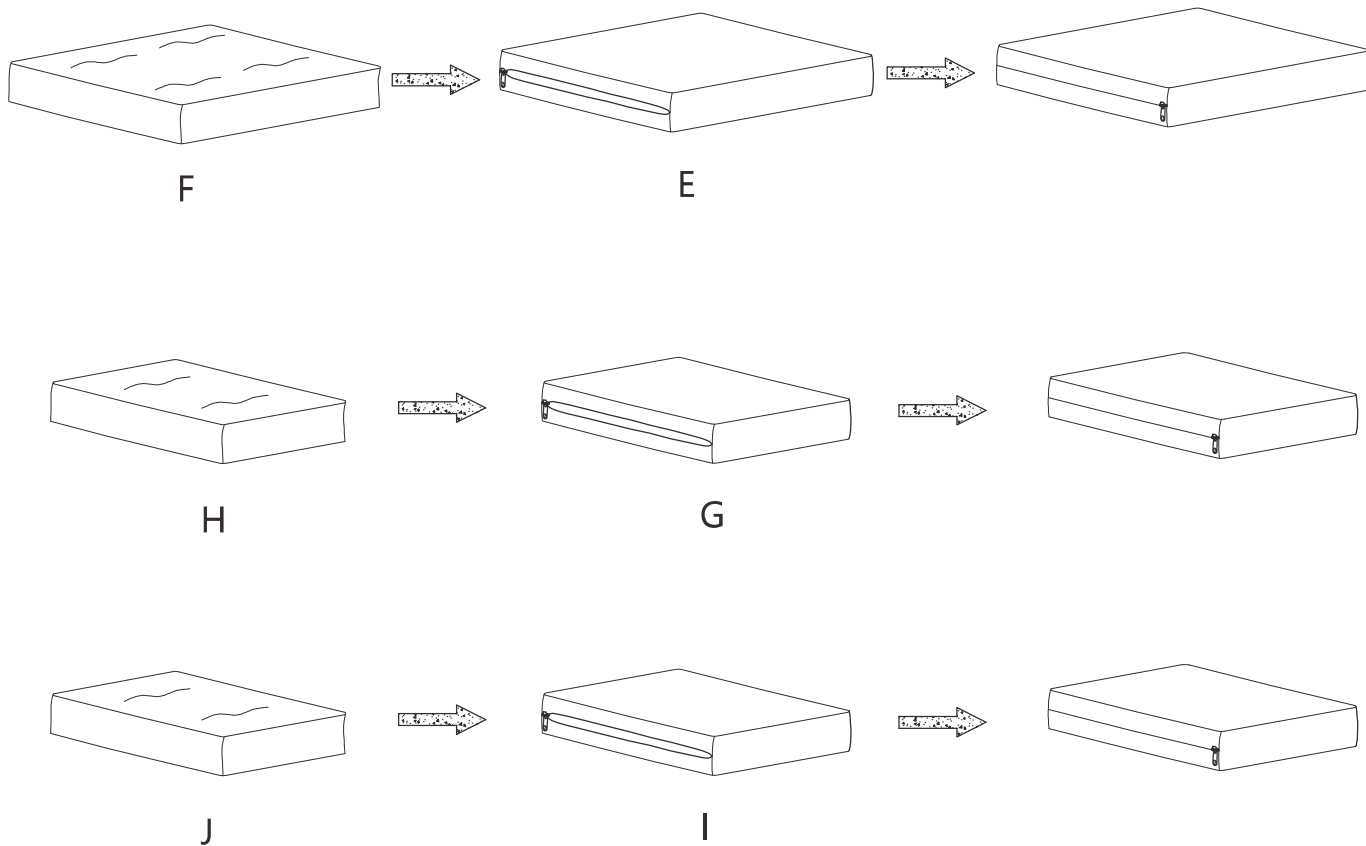

Step 6. Carefully turn the assembled loveseat upright and add cushions as shown below.

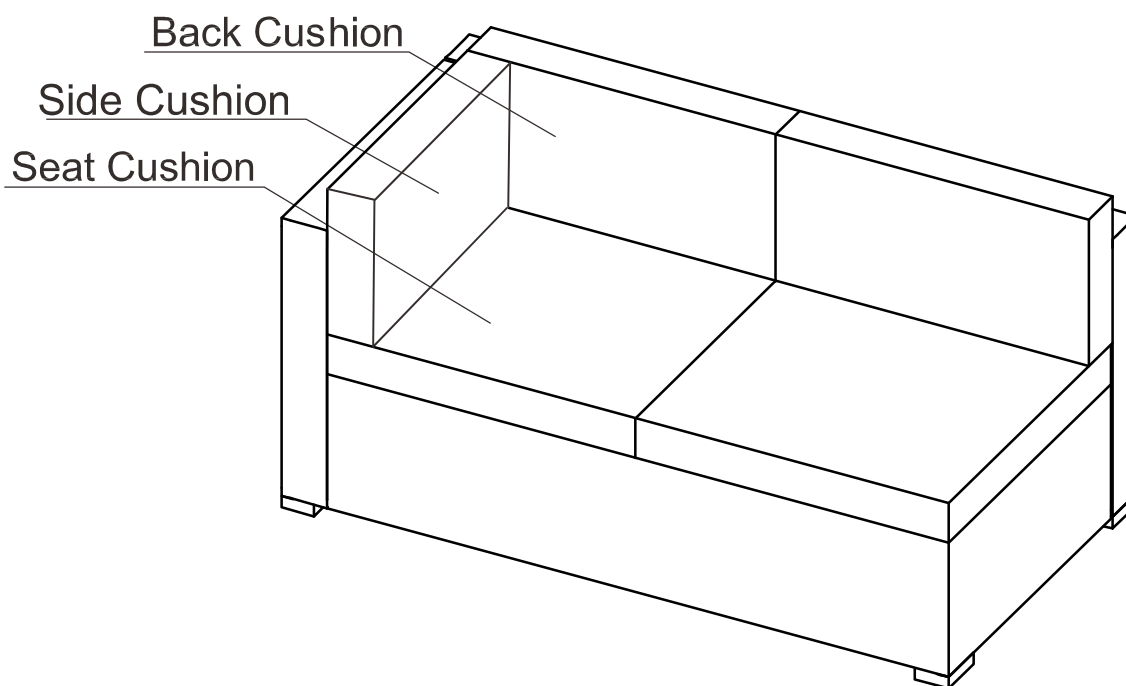

Step 7. Use plastic clips (part #10) to secure additional units together as shown.

