

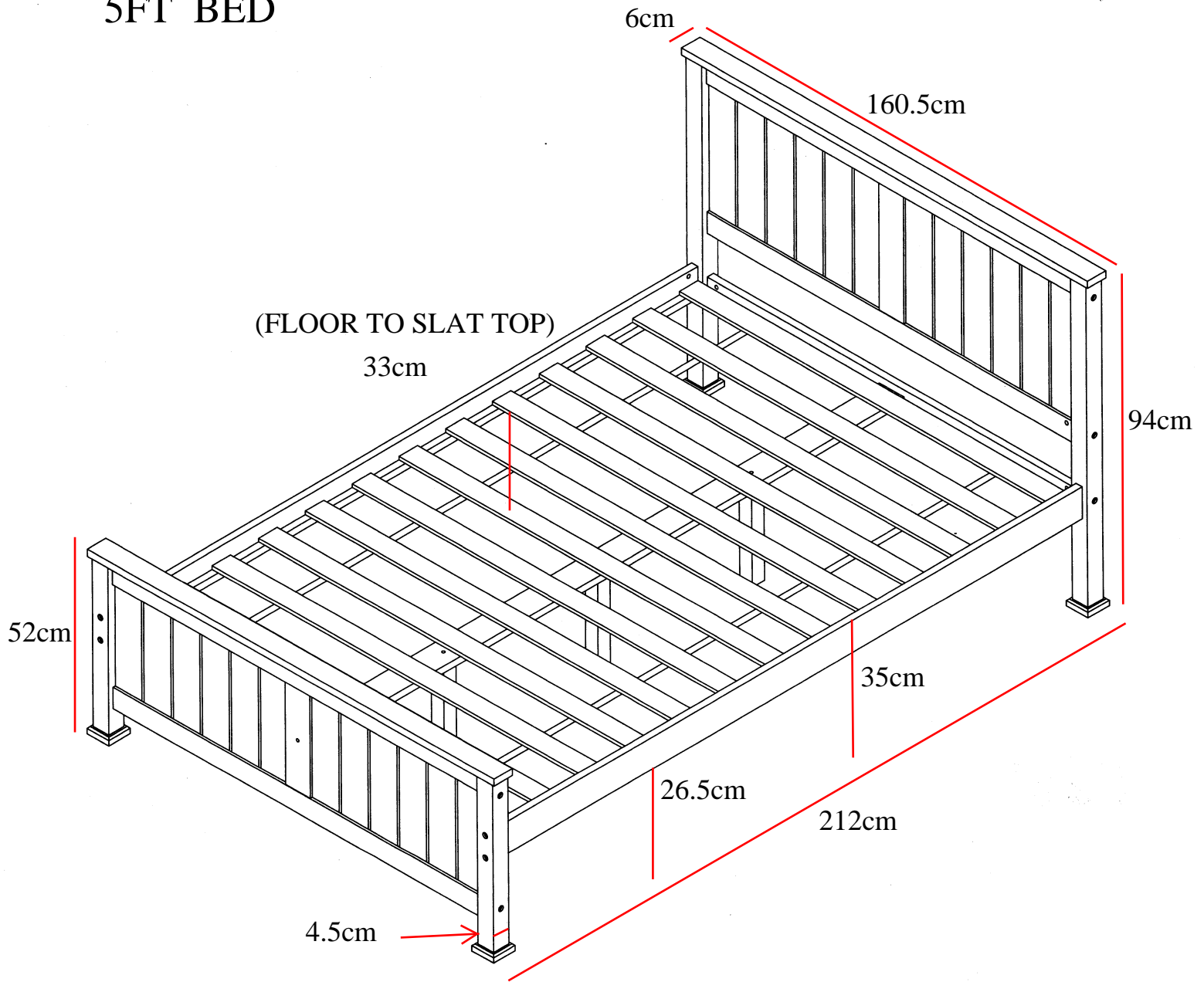









# 5FT BED

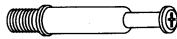

A		M6*90	18
B			18
C		Φ8*30	32
D		Φ7*50	9
E			6

F		1510	6
G		4*30	26
H		Φ12	2
J		Φ15	24
K		4 mm	1

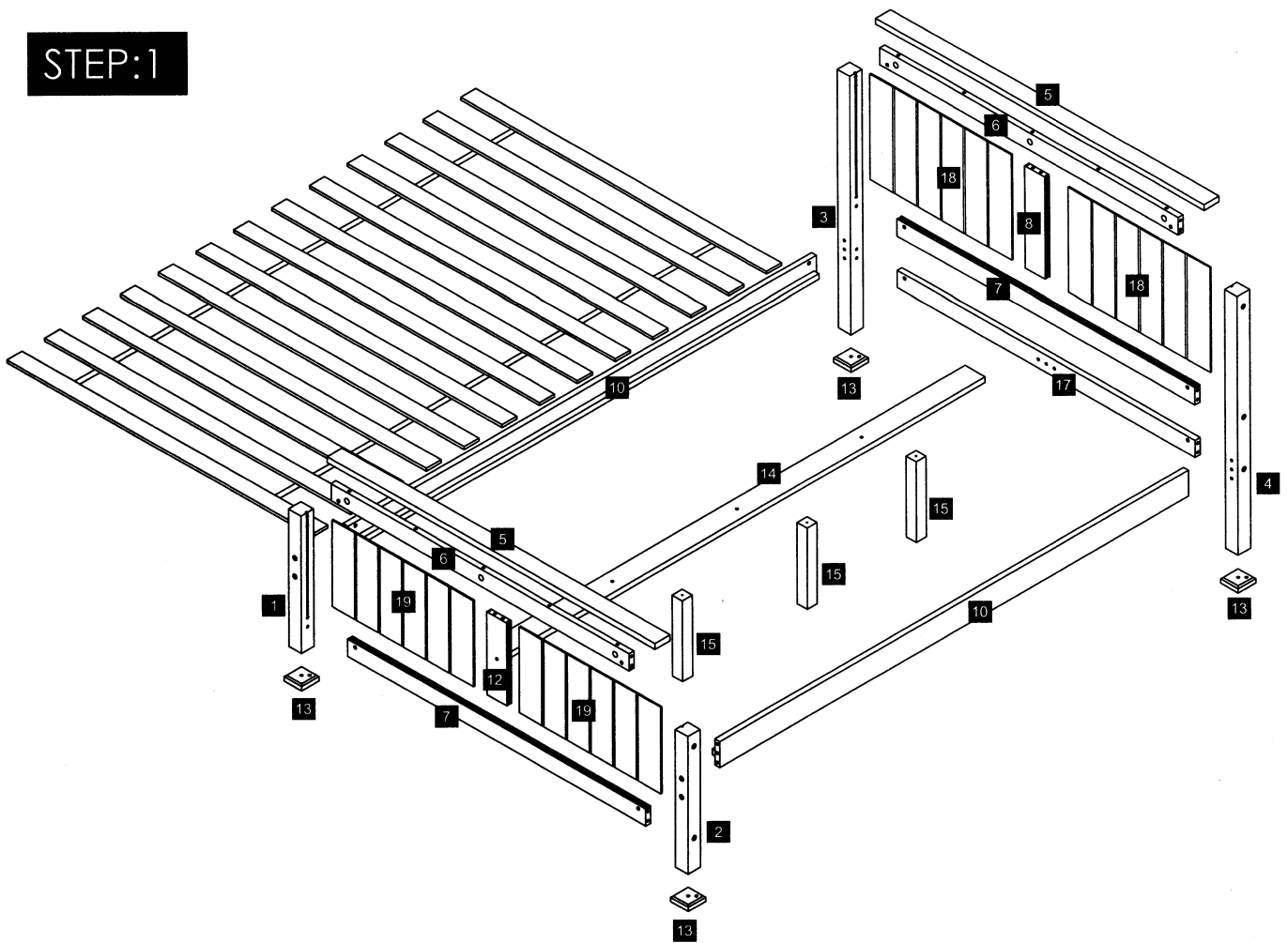

**STEP:1**

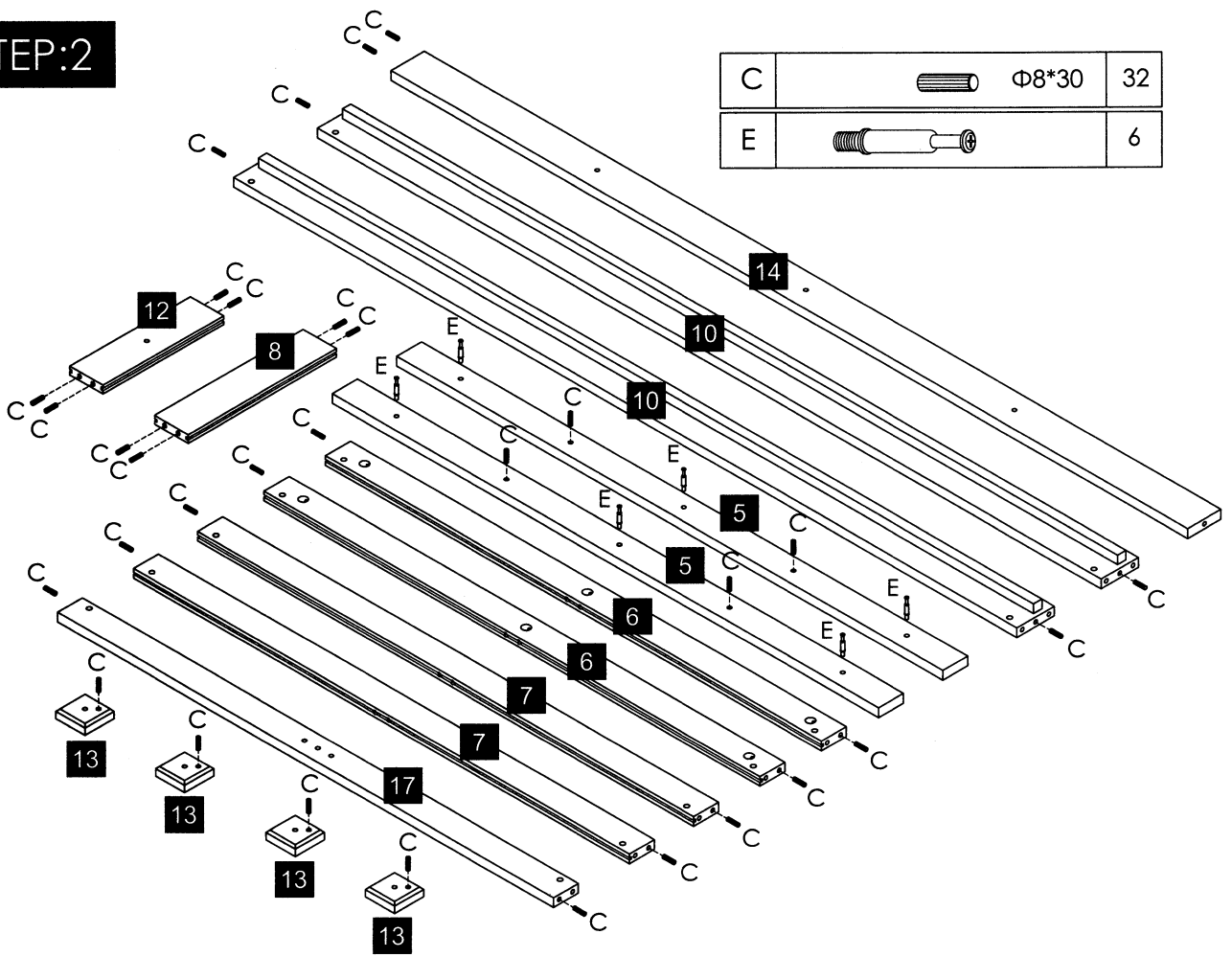

**STEP:2**



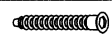

# STEP:3

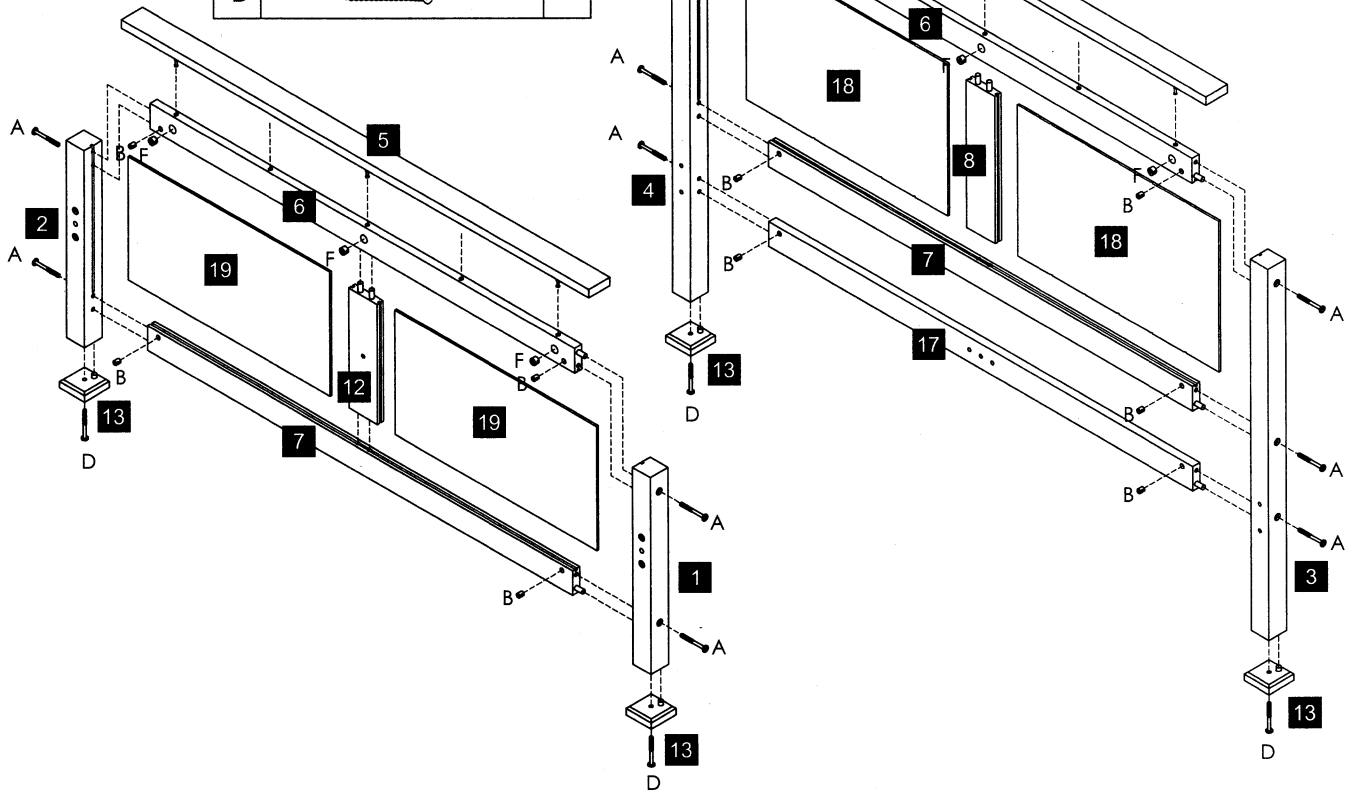
A		M6*90	10
B			10
F		1510	6
D		Φ7*50	4



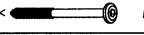

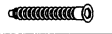
# STEP:4

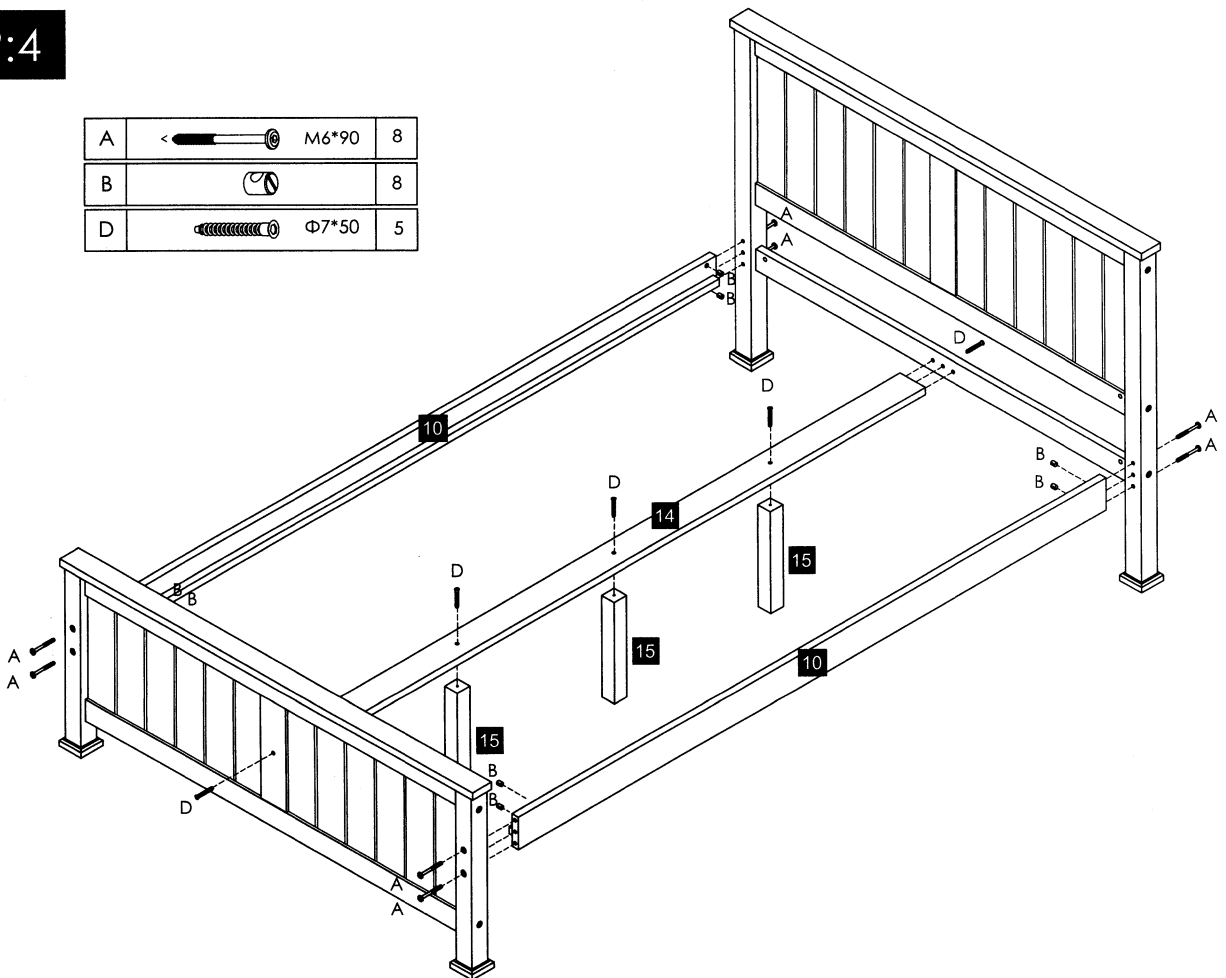
A		M6*90	8
B			8
D		Φ7*50	5



# STEP:5

G		4*30	26
H		Φ12	2
J		Φ15	24

