

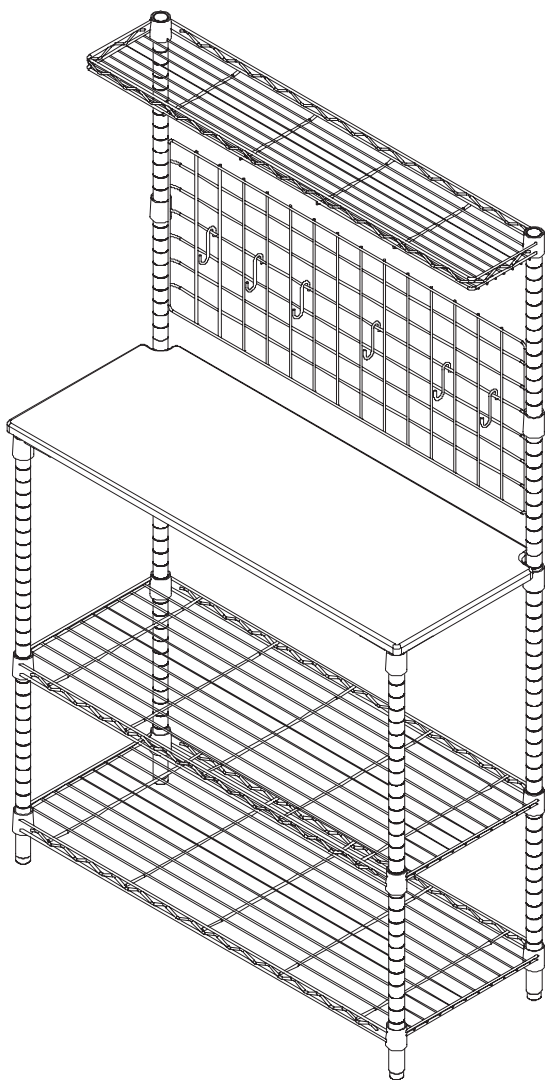

chrome baker's rack
repisa de panadero de cromo
casier de boulangerie chrome

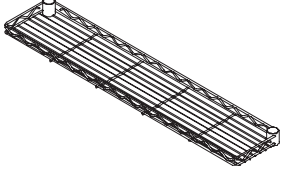

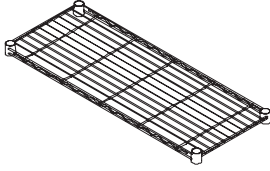
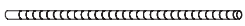

35.75 in L x 14.25 in W x 61.25 in H / 90.8 cm L x 36.2 cm W x 155.6 cm H

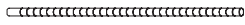
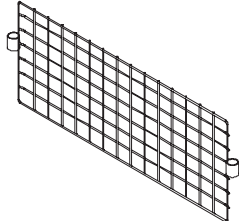
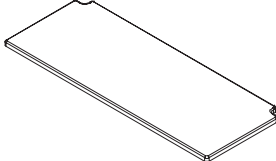
PARTS LIST

PART/ILLUSTRATION	(QTY)	DESCRIPTION
A 	(1)	upper shelf estante superior étagère supérieure
B 	(2)	lower shelves estantes más bajos étagères inférieures
C 	(2)	front lower supports soportes frontal inferior des supports inférieurs avant
D 	(2)	back lower supports soportes de espalda baja supports au bas du dos
E 	(2)	upper supports soportes superiores supports supérieurs
F 	(1)	vertical rack vertical del bastidor crémaille verticale
G 	(1)	shelf estante étagère

PARTS LIST

PART/ILLUSTRATION	(QTY)	DESCRIPTION
H 	(16)	shelf supports soportes del estante supports d'étagères
I 	(2)	bushings bujes douilles
J 	(4)	levelers niveladores niveleurs
K 	(4)	shelf supports soportes del estante supports d'étagères
L 	(8)	screws tornillos vis
M 	(6)	s-hooks s-ganchos s-crochets
N 	(4)	packaging embalaje conditionnement 

TOOLS NOT INCLUDED

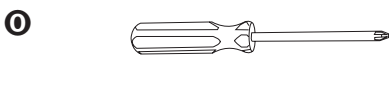

phillips screwdriver
destornillador Phillips
tournevis cruciforme

ASSEMBLY

1

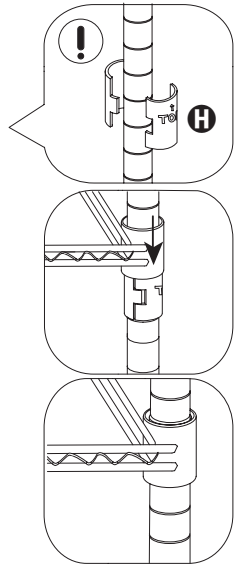
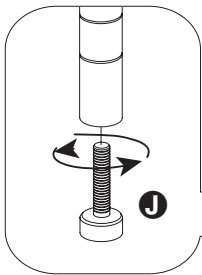
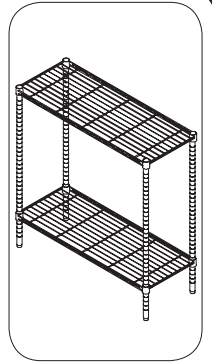
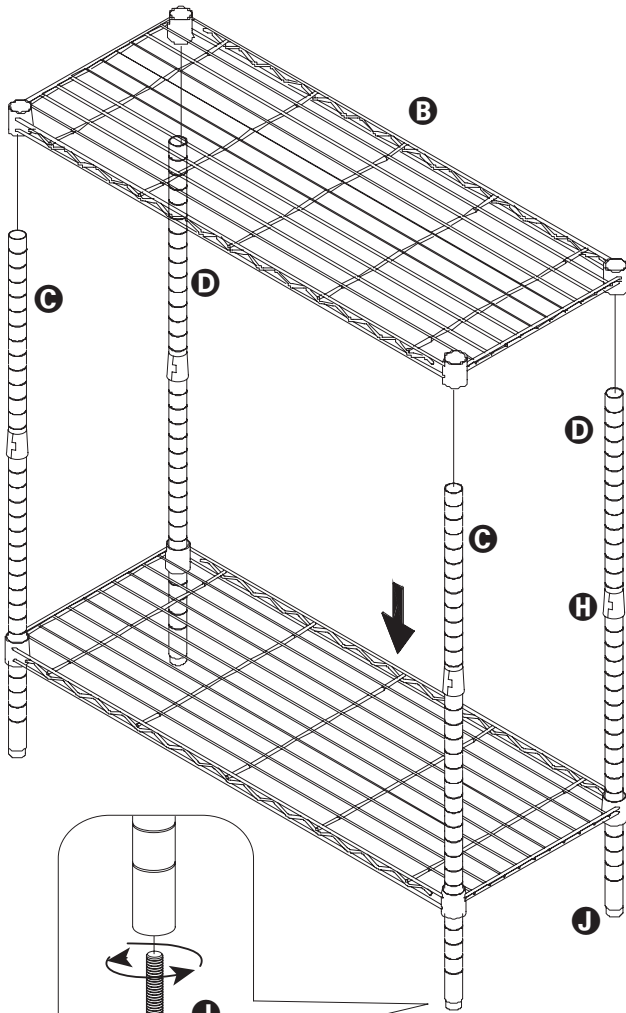

ASSEMBLY

2

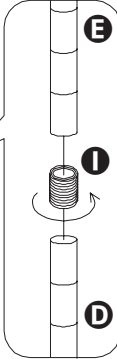
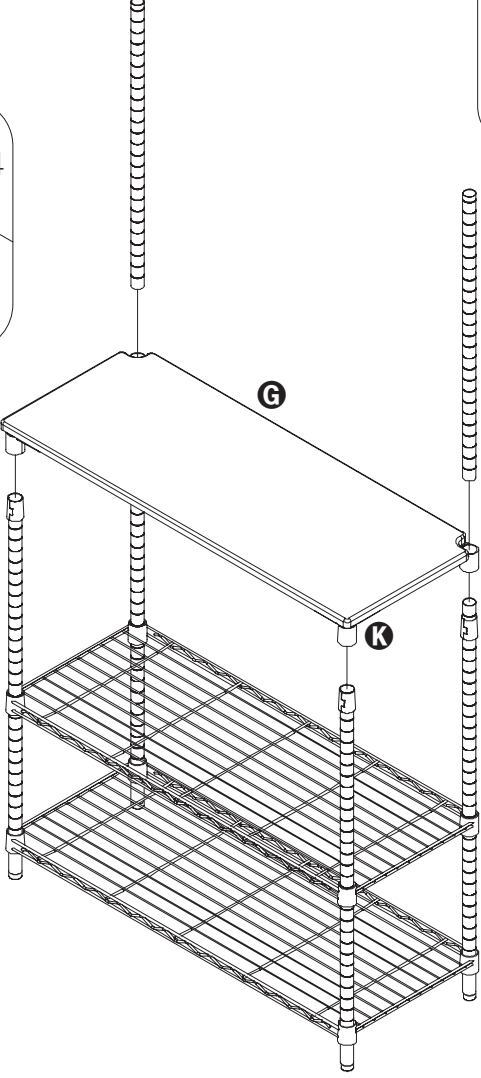
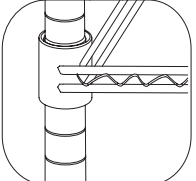
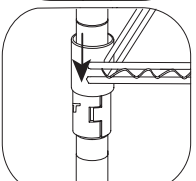
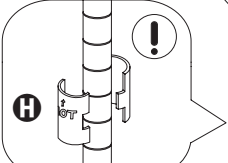
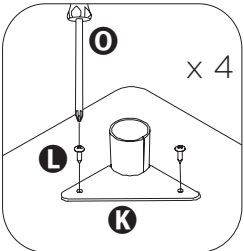
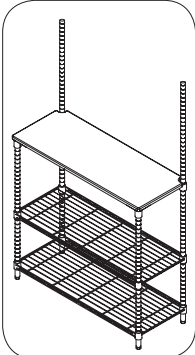

ASSEMBLY

3

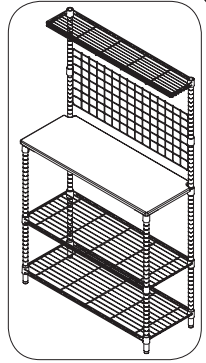
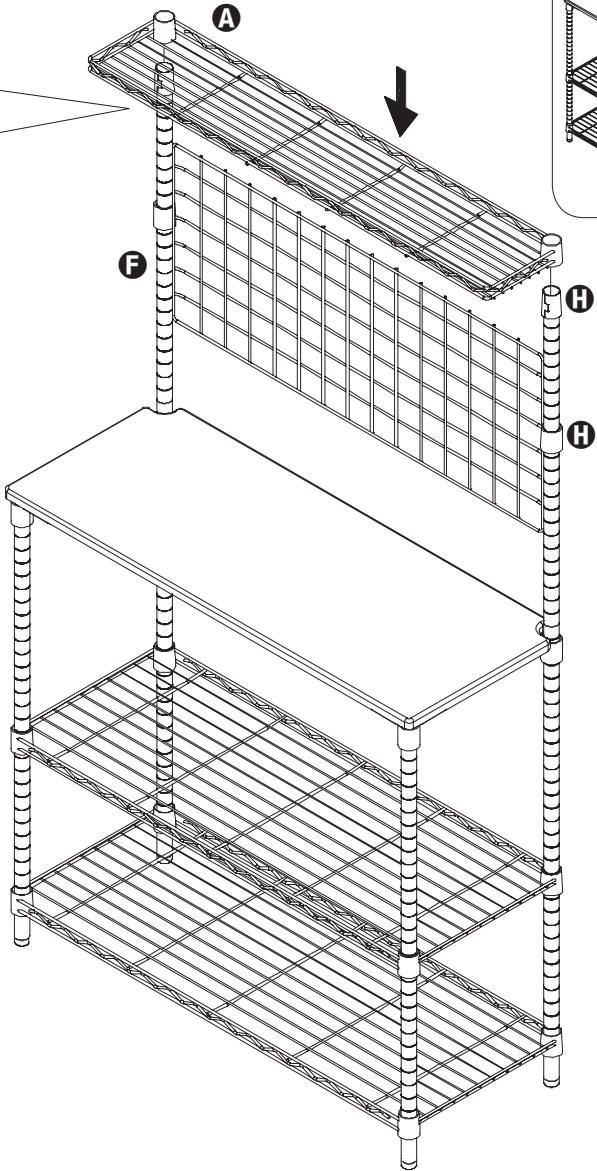
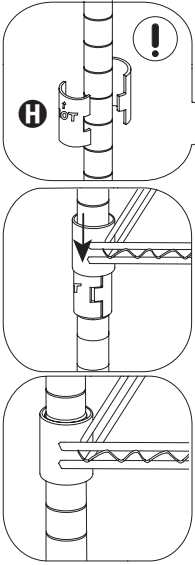

ASSEMBLY

4

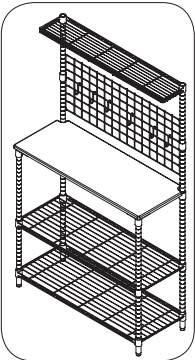
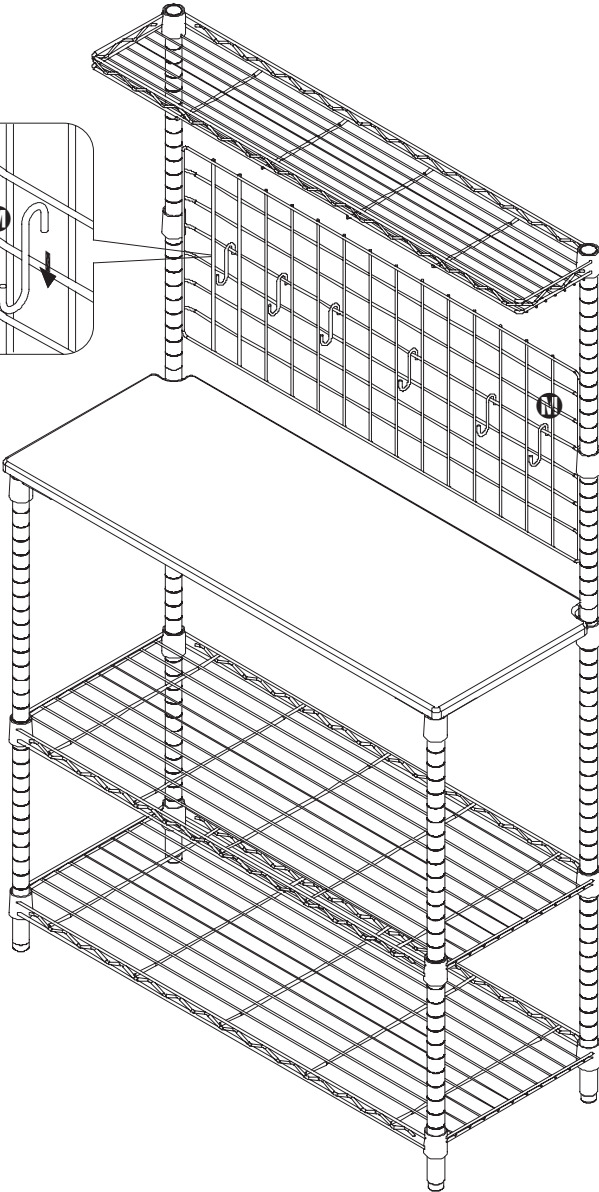
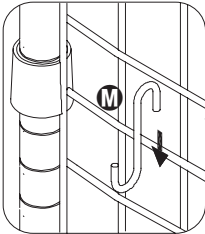

WARNING:

Keep bags and plastic sheeting away from babies and children. Do not use in cribs, beds, carriages or playpens. The plastic may cling to the nose and mouth and prevent breathing.

ADVERTENCIA:

Mantenga las bolsas y láminas de plástico fuera del alcance de los niños y los bebés. No debe usarse en cunas, camas, carriolas o corrales de juego. El plástico puede adherirse a la nariz y boca y provocar asfixia.

AVERTISSEMENT:

Garder les sacs et les bâches en plastique à l'écart des bébés et des enfants. Ne pas utiliser dans des berceaux, des lits, des voitures ou des parcs de jeu. Le plastique peut s'accrocher au nez et à la bouche et empêcher la respiration.

