







Installation

STEP 1

No.	Parts	Quantity
①		1
②		2
③		1
④		1

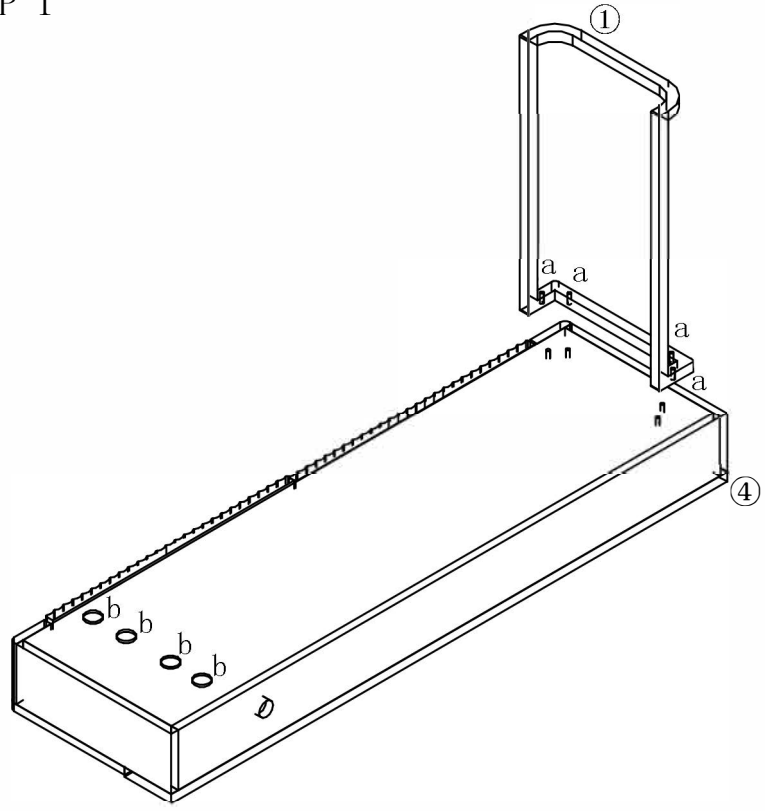

STEP 2

No.	Parts	Quantity
a		M6*35=4
b		4

