

Assembly Instructions

Caution : You must read this before you proceed

Please look in the inner box for hardware pack and legs.

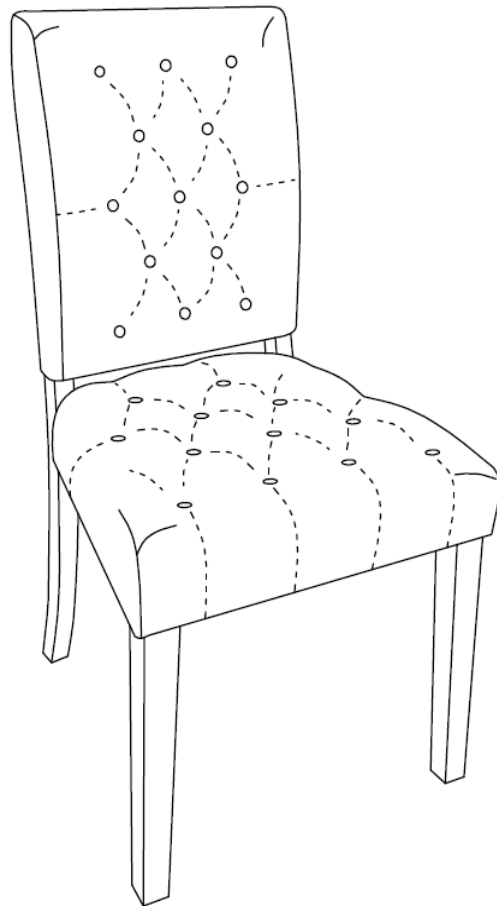



CHAIR

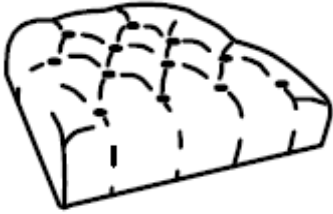
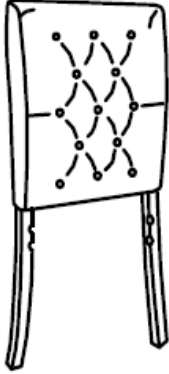
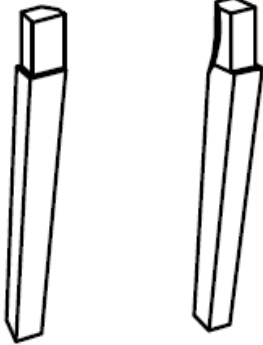

Parts List

Label	Picture	Description	QTY
A		Seat	1
B		Back with Legs	1
C		Front Leg	2

Hardware

Label	Picture	Description	QTY
①		Bolt (M8*57MM)	5
②		Bolt (M8*70MM)	5
③		Spring Washer	10
④		Washer	10
⑤		Allen Wrench	1

Assembly Preparation

Before Beginning Assembly :

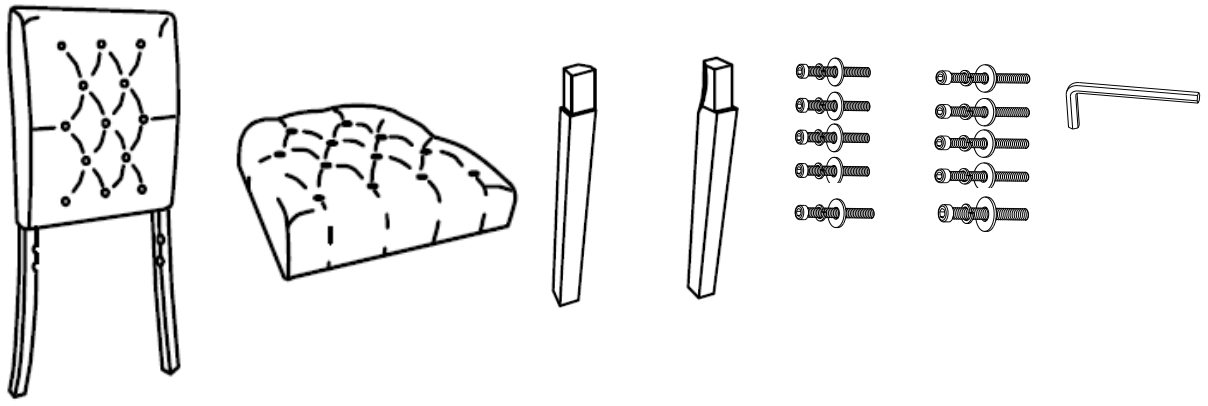

- Read instructions, cover to cover-



- Have 2 adults on hand for assembly-



- Do not assemble on flooring or carpet-



- Assemble on a clean non-marring surface (packing foam)-



- Save all packaging until finished-

Assembly Steps

Overview

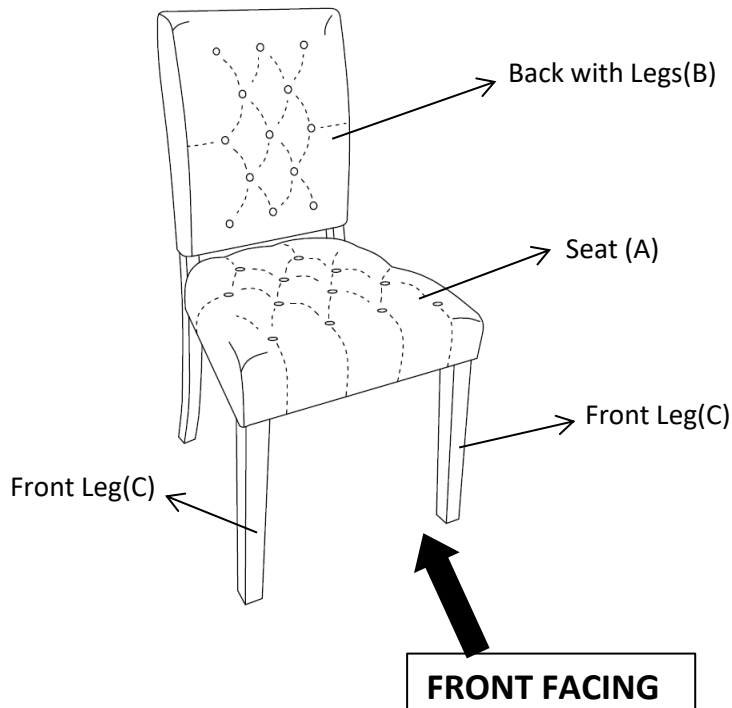

This Chair has multiple parts and may require up to 30 minutes to assemble. To give you an overview of the Chair parts, the above picture is to help you put the various parts into perspective. Please read through the instructions below to familiarise yourself with the parts and steps before assembly.

Step 1

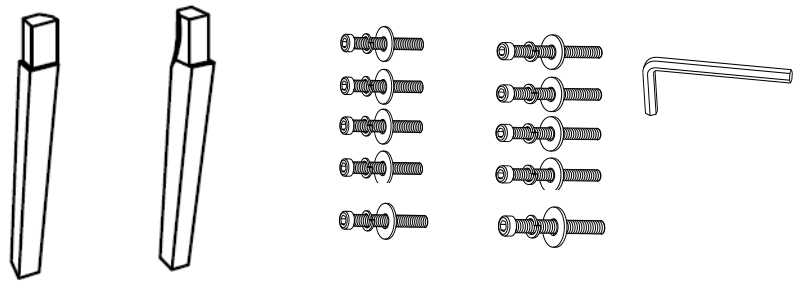

Open the inner box carefully and remove the Front Legs (C) and hardware pack from the inner box, then place them on a clean, non-marring surface.

Step 2

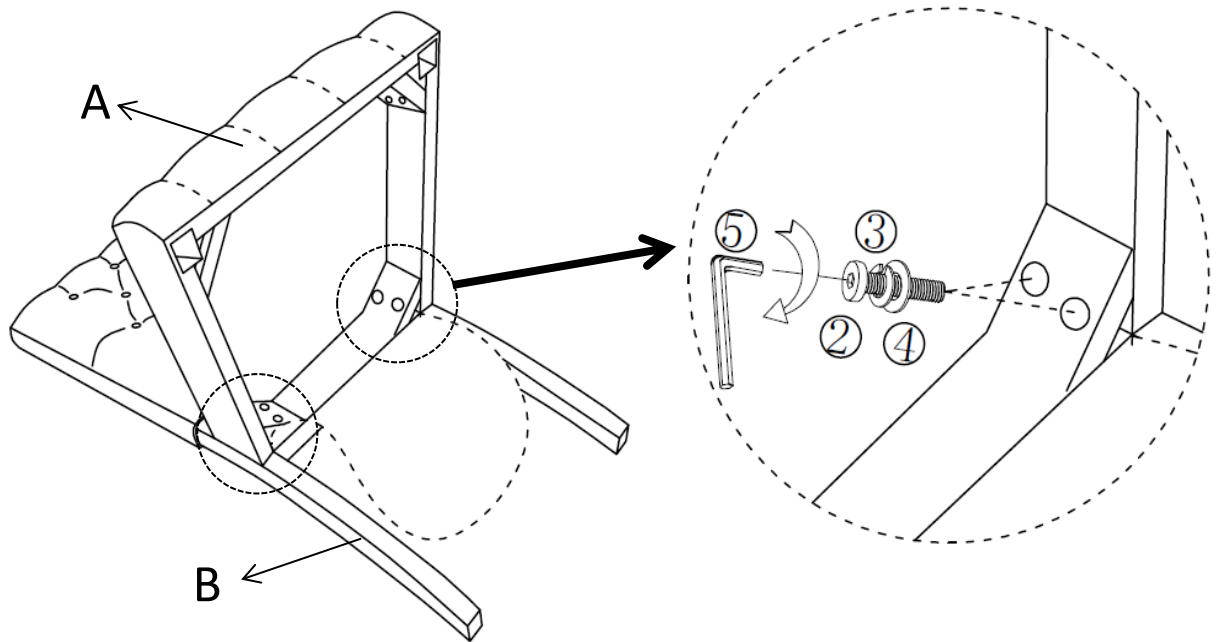

Place the Back with Legs (B) on a clean, non-marring surface. Carefully open the Dust Cover on the bottom side of the Seat (A).

Attach the Seat (A) to the Back with Legs (B) using Bolts (2), Spring Washers (3) and Washers (4) with the Allen Wrench (5).

Do not fully tighten the Bolts.

Step 3

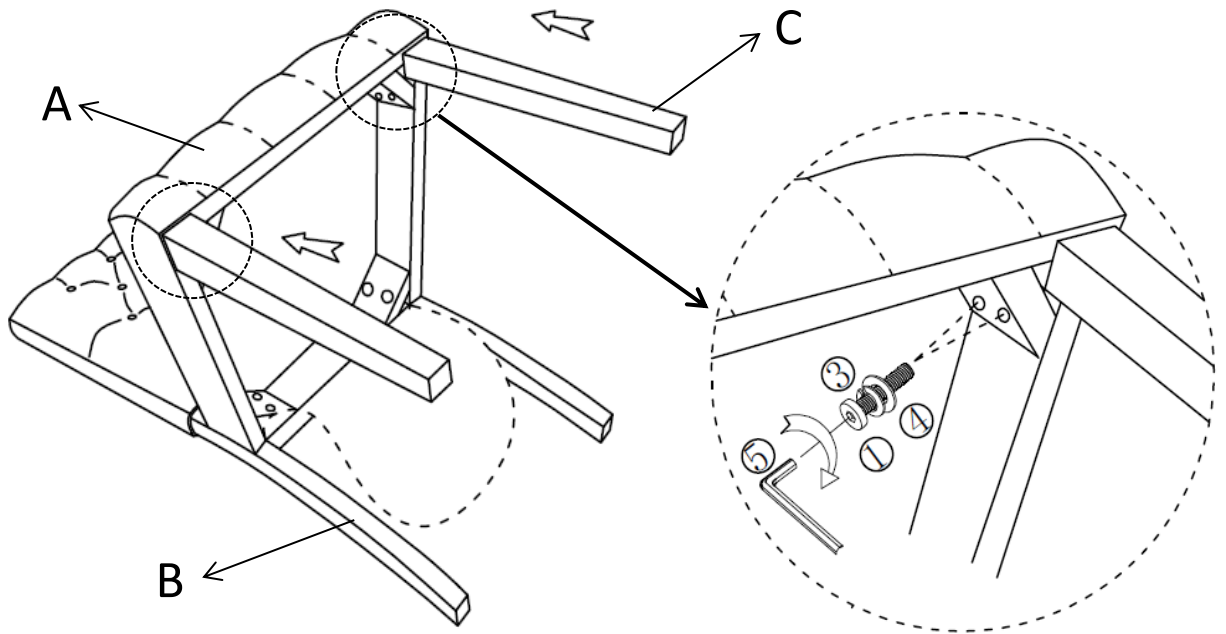

Attach the two Front Legs(C) into the Seat(A) using Bolts(①), Spring Washers(③) and Washers(④) with the Allen Wrench(⑤).
Do not fully tighten the Bolts.

Step 4

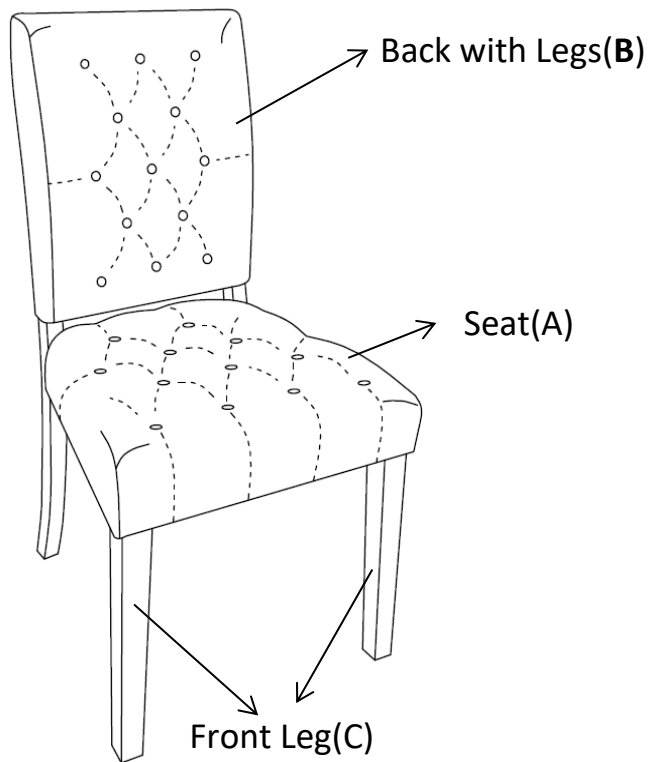

Test for Stability

Stand the Chair up.
Place the Chair on a **LEVEL SURFACE**.
Inspect it and make sure all parts are adequately connected.
Gently and carefully, sit on the Chair.
This will help to align all parts at all joints.
Then get off the Chair, and carefully place the Chair facedown.
Then proceed to tighten all Bolts at all joints in a sequential manner.
If there are any wobbles after tightening, loosen the Bolts and execute the same process.

Step 5

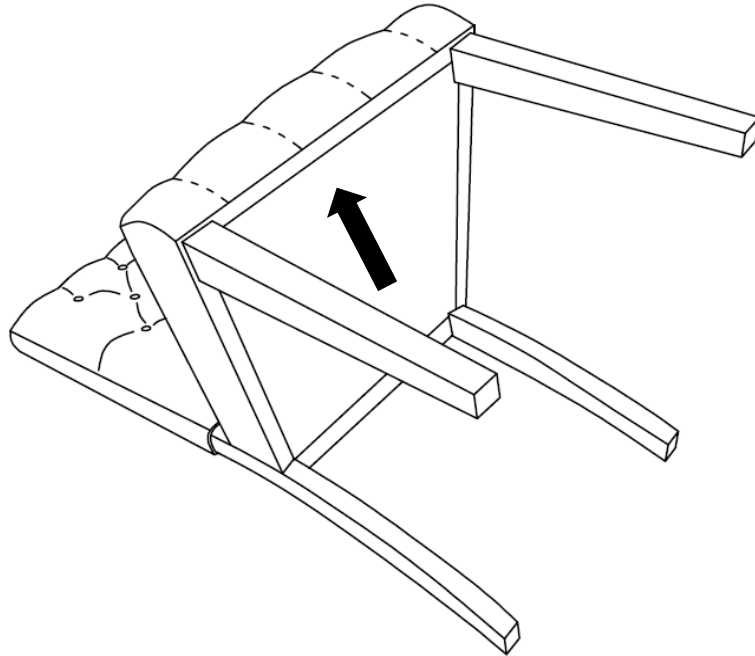





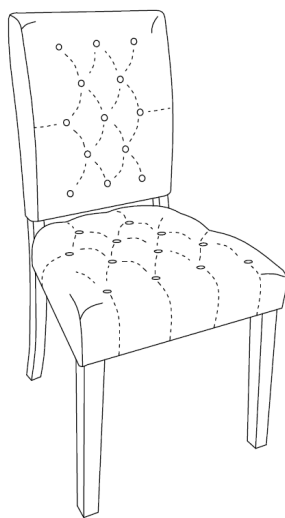













Finally, seal the Dust Cover back on the underside of the Seat(A).



Step 6



Stand the chair right side up.
Your Chair is ready for use.
This Chair can only be used on a flat, level surface.

Care & Maintenance

-   ● Furniture may scratch floors. We recommend using furniture pads to protect your floors.
-   ● Do not put hot items directly on furniture surface.
-   ● Do not clean furniture with harsh cleansers or polish.
-   ● Do not place furniture under direct sunlight.
-   ● Do not place furniture near heating or cooling vents.
-   ● Do not write on furniture without a padded barrier to protect the surface.
-   ● Do not place furniture outside . For indoor use only.
-   ● Not for commercial use. For residential use only.
-   ● Stains may be removed with mild soap solution and damp cloth.
-   ● Children should not climb or jump on the furniture.

-   ● Dust and pick-up spills using a clean, non-colored, lint-free cloth.