





Assembly instructions for the table, including warnings, time, and person requirements.

**Warning 1:** Do not use a power drill. Use an Allen key (shown in a circle) to tighten the legs. 

**Warning 2:** Do not place the table on a soft surface like a rug. Place it on a hard, flat surface. 

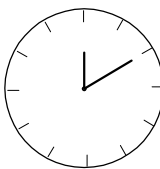
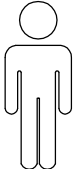
**Time:** 10' 

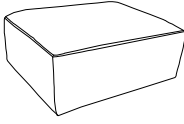
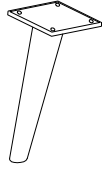
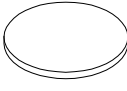
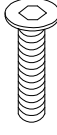
**Person:** 1 

|   |   |   |  |   |
|---|---|---|--|---|
| <b>A</b>  | <b>B</b>  | <b>C</b>  | <b>D</b>   | <b>E</b>  |
|  |  |  |  M6<br>x<br>20 |  |
| <b>x 1</b>  | <b>x 4</b>  | <b>x 4</b>  | <b>x 16</b>  | <b>x 1</b>  |

**A**

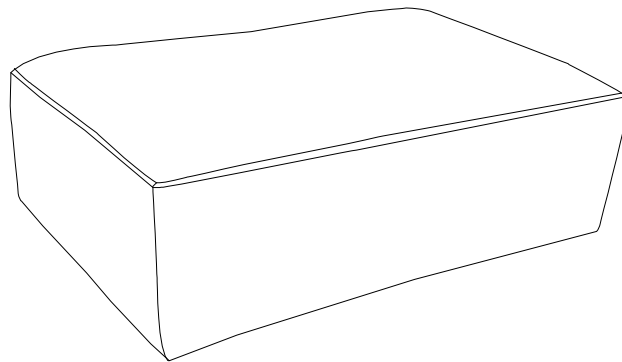

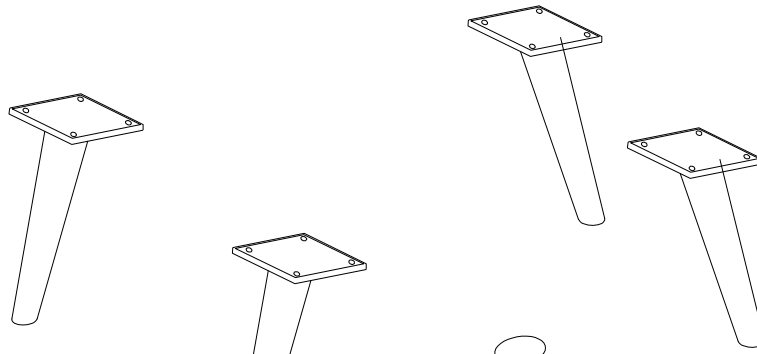

**B x 4**



**C x 4**

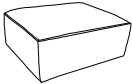
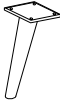

1

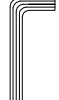
|   |   |   |  |   |
|---|---|---|--|---|
| <p>A</p>  <p>x 1</p> | <p>B</p>  <p>x 4</p> | <p>C</p>  <p>x 4</p> | <p>D</p>  <p>M6<br/>x<br/>20<br/>x 16</p> | <p>E</p>  <p>x 1</p> |
|---|---|---|--|---|

