

Tel: 828-728-3261
www.americandrew.com

TOOLS REQUIRED:

Allen Wrench (supplied, part # D)

BEFORE YOU START:

1. Check the parts against the parts list to make sure all items are present.
2. Assemble your furniture on a soft, flat surface to avoid scratching the finish.
3. **CAUTION:** Do not over tighten screws, nuts or bolts during assembly.
4. Your furniture may require occasional tightening.

INSTRUCTIONS:

1. Turn the table top on the smooth and clean soft surface.
2. Attach four posts to the top, using Bolt(A), Lock Washer (B), Flat Washer (C) and tighten with Allen Wrench (D). As shown in Figure 1 (STEP 1).
3. Put the bottom shelf onto the posts .
4. Attach the legs by turning it to the bottom shelf. As shown in Figure 1 (STEP 2).
5. Turn the table up after assembled. Tighten all bolts before using it.
6. To level the table, please adjust the bottom levelers accordingly. As shown in Figure 2.

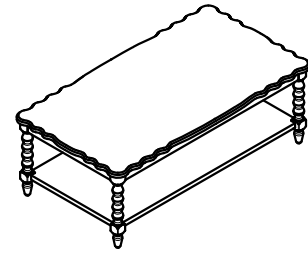

Figure 1

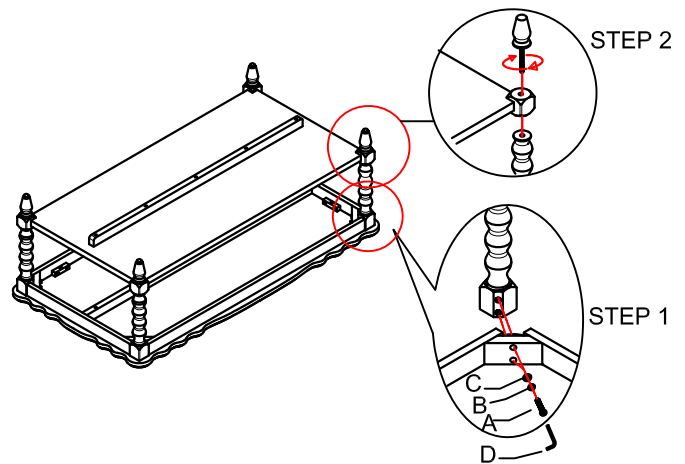
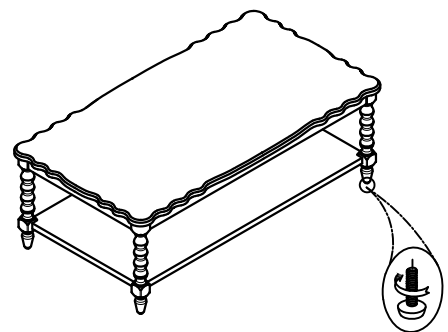





Figure 2



HARDWARE LIST

NO	DRAWING	DESCRIPTION	SIZE	Q'ty
A		Bolt	5/16"x50mm	8pcs
B		Lock washer	ø5/16"	8pcs
C		Flat washer	ø5/16"x19mm	8pcs
D		Allen Wrench	100x50x4mm	1pc

Thank you for purchasing furniture
from american drew!