









Assembly Instructions

Caution: You must read this before you proceed

Care & Maintenance

	<ul style="list-style-type: none">● Not for commercial use. For residential use only.
	<ul style="list-style-type: none">● Do not put hot items directly on furniture surface.
	<ul style="list-style-type: none">● Do not clean furniture with harsh cleansers or polish.
	<ul style="list-style-type: none">● Do not place furniture under direct sunlight.
	<ul style="list-style-type: none">● Do not place furniture near heating or cooling vents.
	<ul style="list-style-type: none">● Do not write on furniture without a padded barrier to protect the surface.
	<ul style="list-style-type: none">● Do not place furniture outside . For indoor use only.
	<ul style="list-style-type: none">● Stains may be removed with mild soap solution and damp cloth.
	<ul style="list-style-type: none">● Children should not climb or jump on the furniture.
	<ul style="list-style-type: none">● Dust and pick-up spills using a clean, non-colored, lint-free cloth.

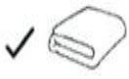
Please look in Corners of carton for hardware packs.

Assembly Instructions

Please look in the Table for Hardware packs and Legs

RECT COFFEE TABLE 2IN1

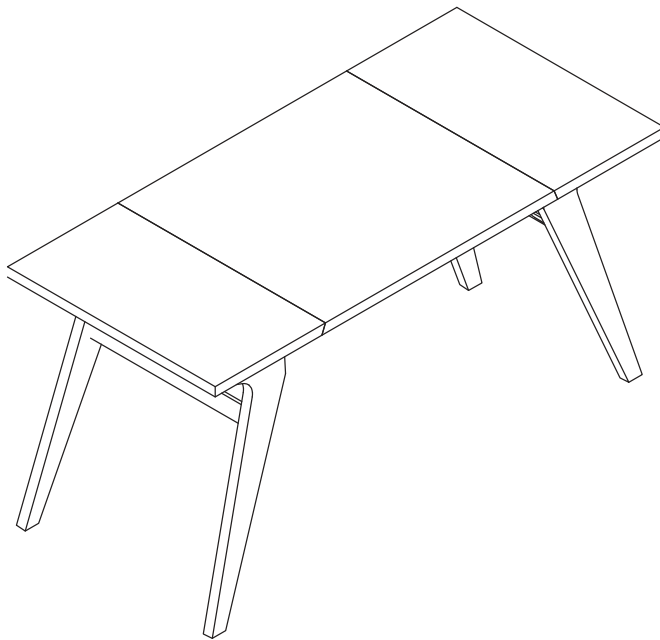

Dining Table

OR

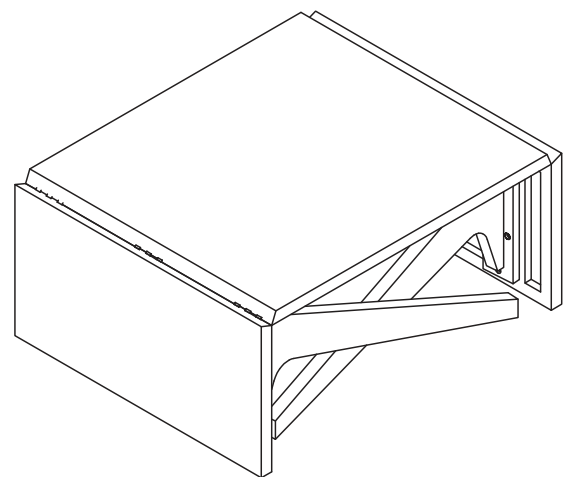

Coffee Table

Caution: This Rect Coffee Table is NOT a TOY. Keep your child / children at bay during the assembly process. Whenever lifting or moving the Loveseat and to prevent damage to the Table, two adults may be needed to execute these actions.

ASSEMBLY INSTRUCTION

Part List

(A)

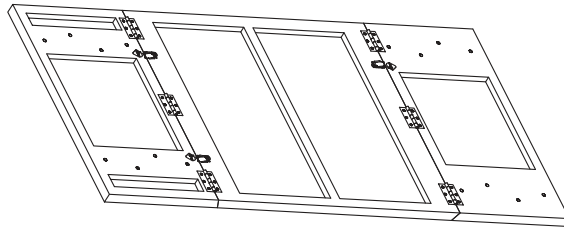
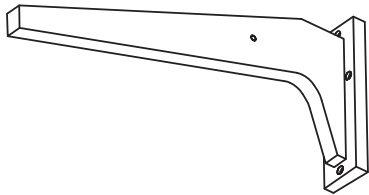

Table Top = 1pc

(B)



Right Legs = 2pcs

(C)

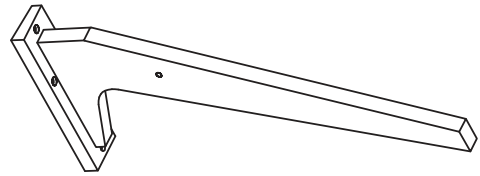

Left Legs = 2pcs

(D)

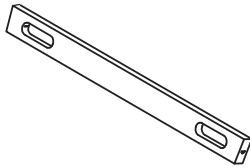

Long Support Leg = 1pc

(E)

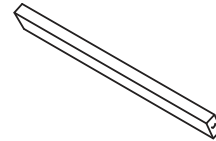

Short Support Leg = 1pc

Hardware List

(1)

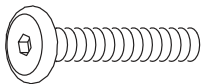

Bolt 1/4" x 38mm =16 pcs

(2)



Bolt 1/4" x 50mm =4 pcs

(3)



Spring Washer =16 pcs

(4)



Flat Washer = 16pcs

(5)



Haft moon Nut =4pcs

(6)

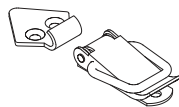

Toggle Latch Clamp =4 sets

(7)



Flat screw= 16 pcs

(8)



Allen Key 4x 80=1 pc

Assembly Preparation

Before Beginning Assembly:

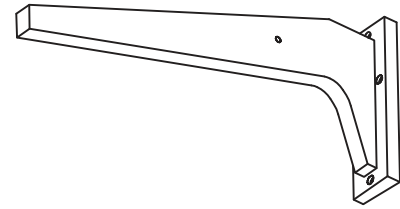
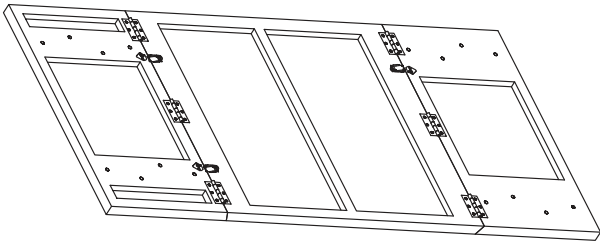

A Table Top = 1pc

B Right Legs = 2pcs

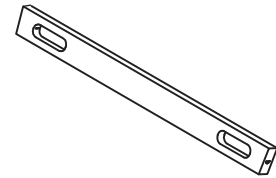
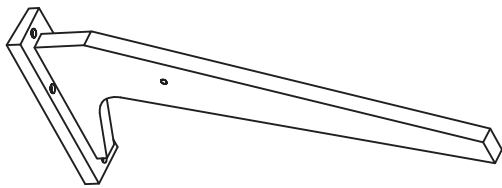

C Left Legs = 2pcs

D Long Support Leg = 1pc

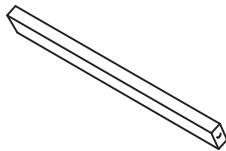

E Short Support Leg = 1pc

1 X 16pcs 

5 X 4 pcs 

2 X 4 pcs 

6 X 4 pcs 

3 X 16 pcs 

7 X 16 pcs 

4 X 16 pcs 

8 X 1 pc 

Assembly Preparation Before Beginning Assembly:



- Read instructions, cover to cover-



- Have 2 adults on hand for assembly-



- Do not assemble on flooring or carpet-



- Assemble on a clean non-marring surface (packing foam)-



- Save all packaging until finished-

Assembly Steps

Overview

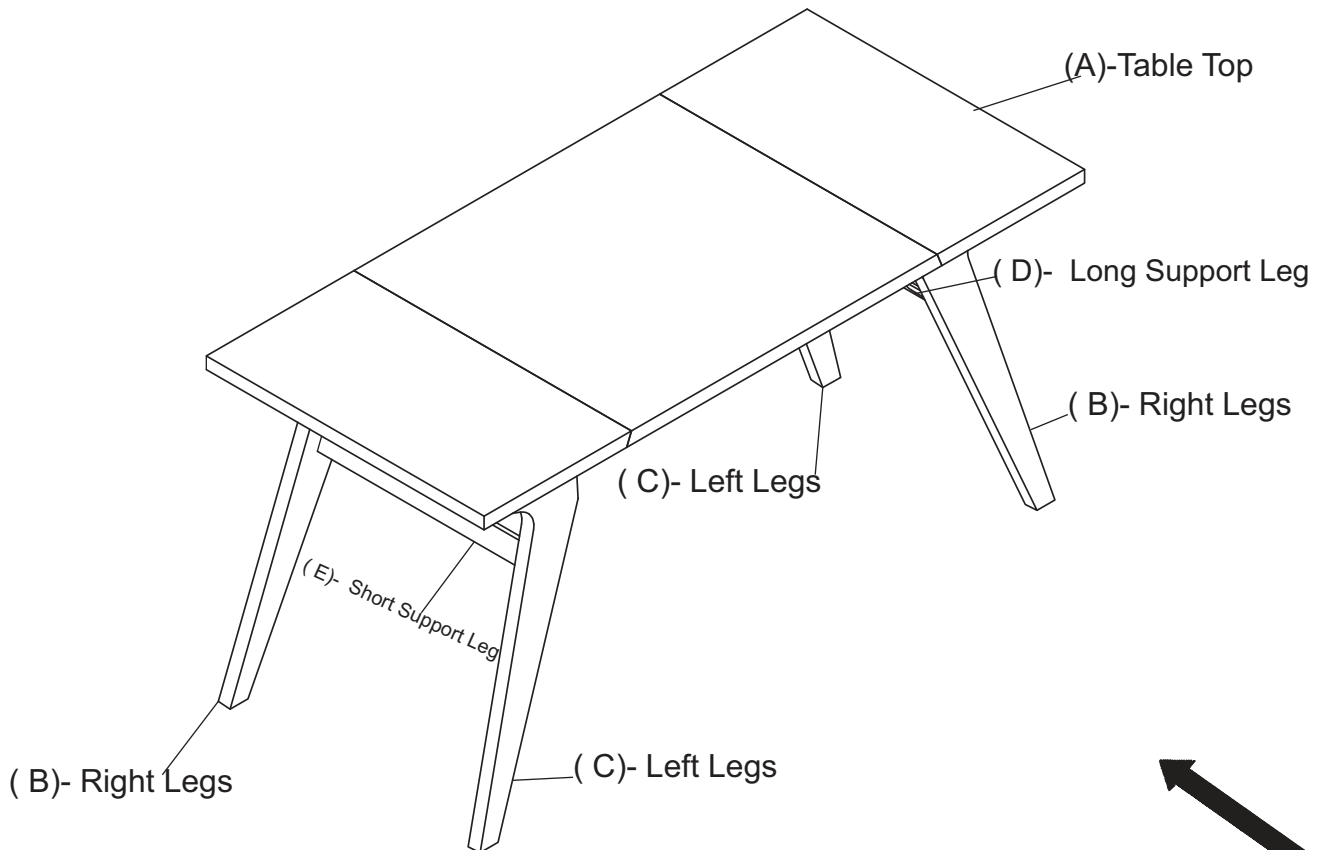

This Rect Coffee Table has multiple parts and may require up to 30 minutes to assemble. To give you an overview of the Table parts, the above picture is to help you put the various parts into perspective. Please read through the instructions below to familiarise yourself with the parts and steps before assembly.

ASSEMBLY INSTRUCTION

Step 1 Unpack and place all parts on clean, non - marring surface.

Place the Table top (A) face down on a clean, flat surface, then unfold the two table legs by hand until they are aligned in the same plane as the center tabletop..

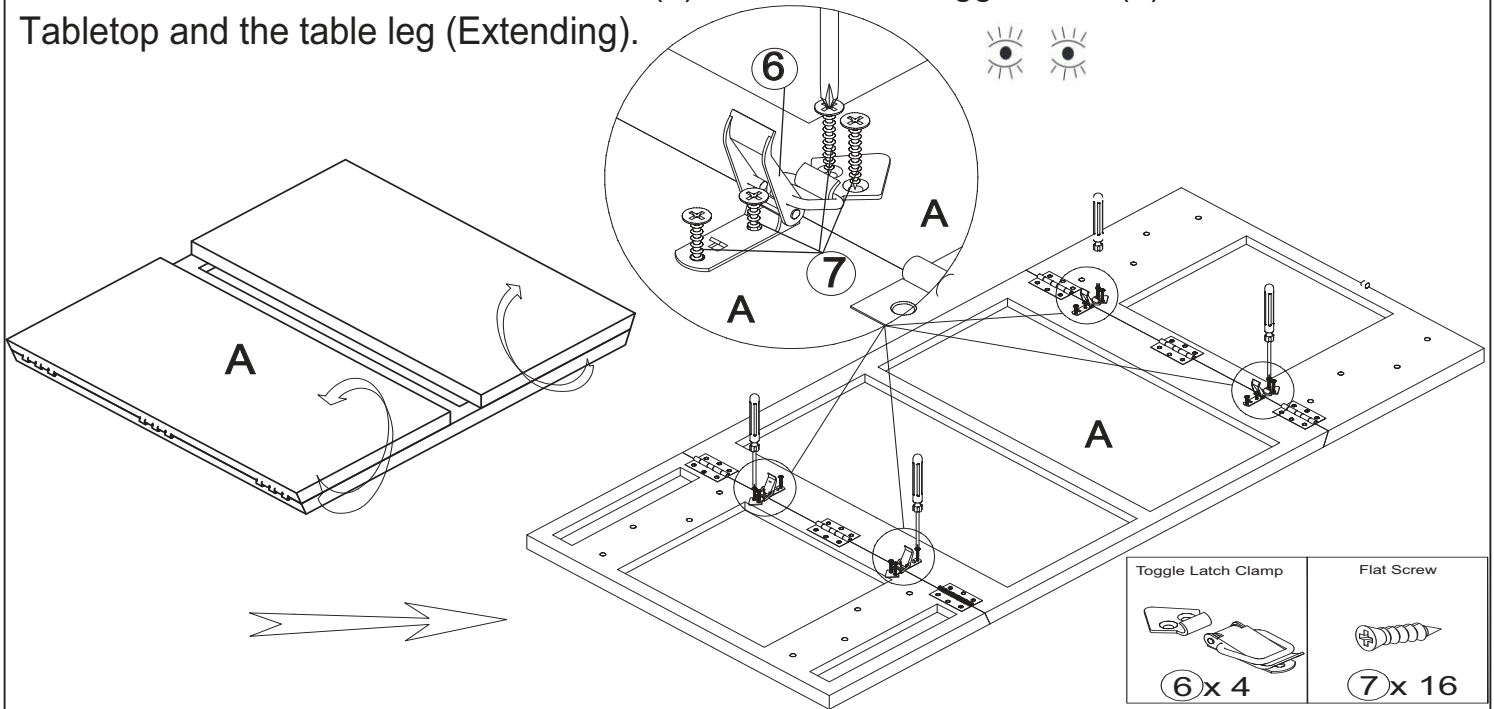

Next, use a screwdriver and flat screws (7) to secure the toggle latch (6) between the center Tabletop and the table leg (Extending).

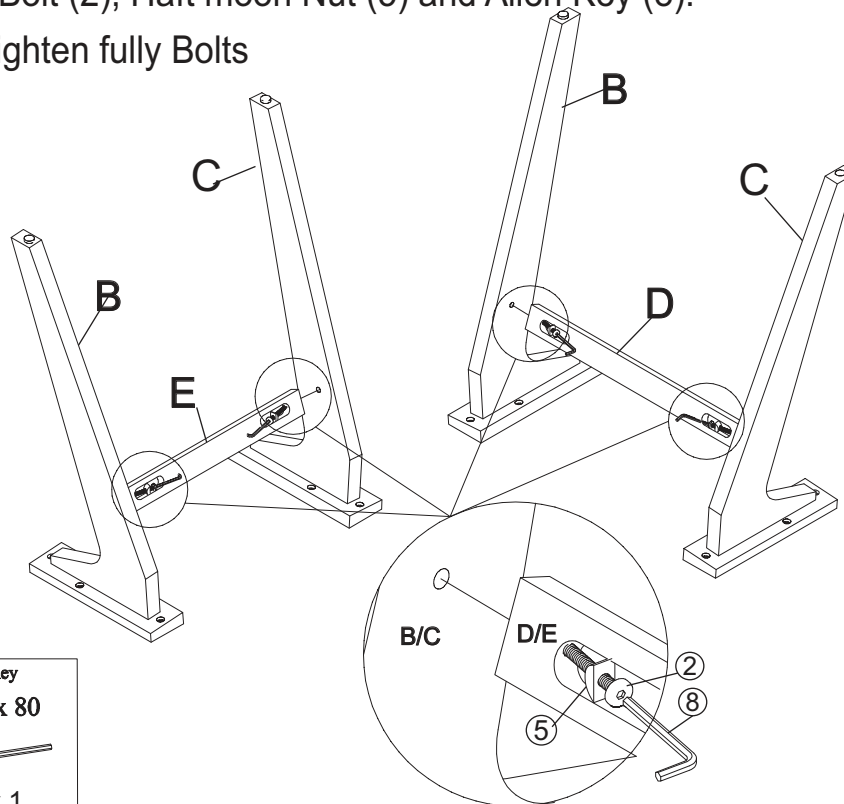

Step 2 Attach the Long and Short Support Legs (D&E) onto the Right Legs (B) and Left Legs(C)
Affix them by using the Bolt (2), Haft moon Nut (5) and Allen Key (8).

As this Step. **DO NOT** tighten fully Bolts



Bolt 1/4" x 50mm	Haft moon Nut 20 x 10	Allen Key K4 x 80
		
2 x 4	5 x 4	8 x 1





ASSEMBLY INSTRUCTION

Step 3

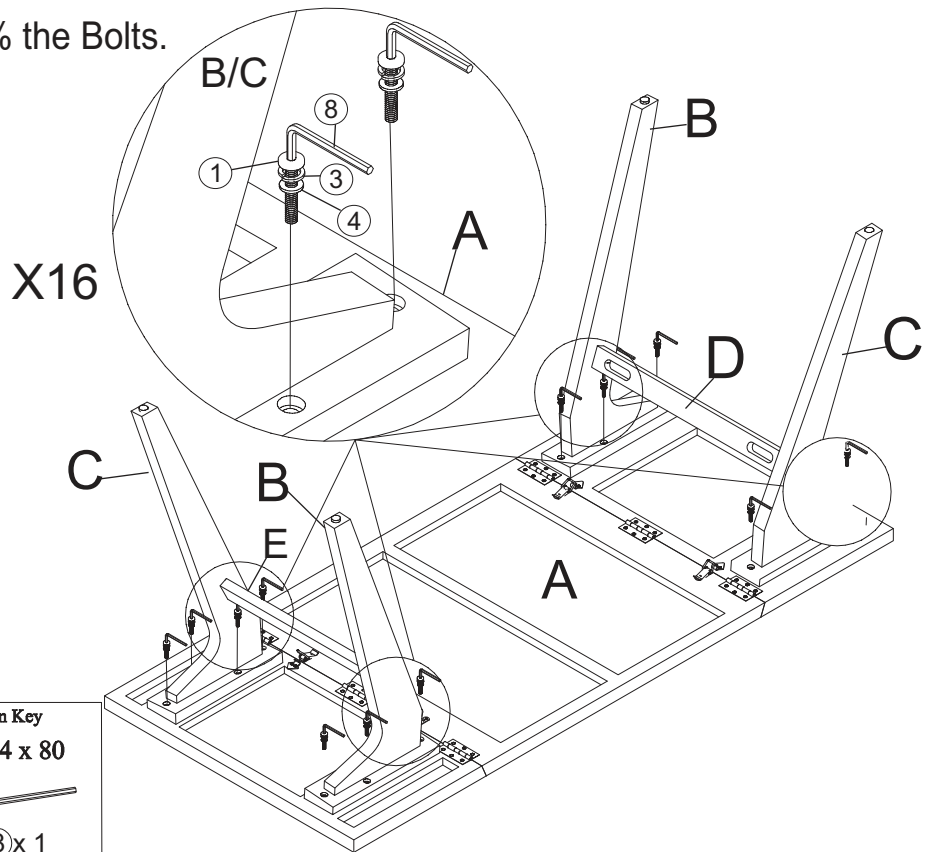
Attach the Frame Leg assembled as step 2 onto the Table Top A. Affix them by using the Bolt (1), Spring washer (3), Flat washer (4) and Allen Key (8).

As this Step. Tighten fully 100% the Bolts.



Bolt	Spring washer	Flat Washer	Allen Key
1/4" x 38mm	∅12 x ∅6	∅12 x ∅6	K4 x 80
			
①x 16	③x 16	④x 16	⑧x 1

Step 4

After installing all accessories, close the Hook of toggle latches by hand to secure the Extending Table Top to the main Table Top.

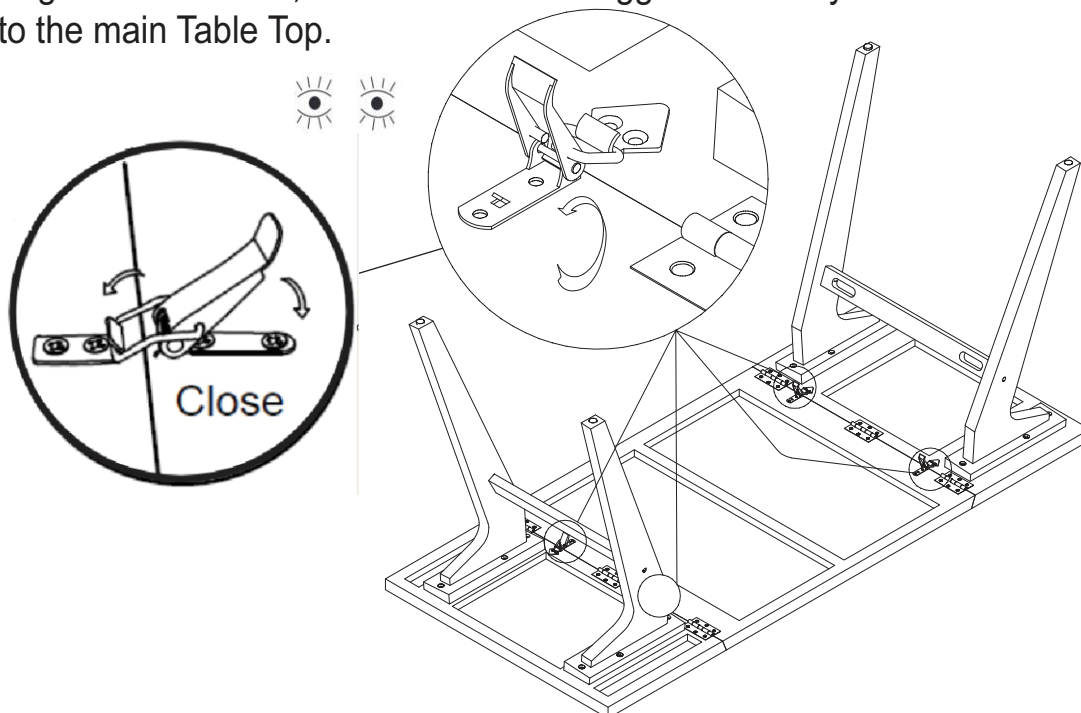

ASSEMBLY INSTRUCTION

Step 4

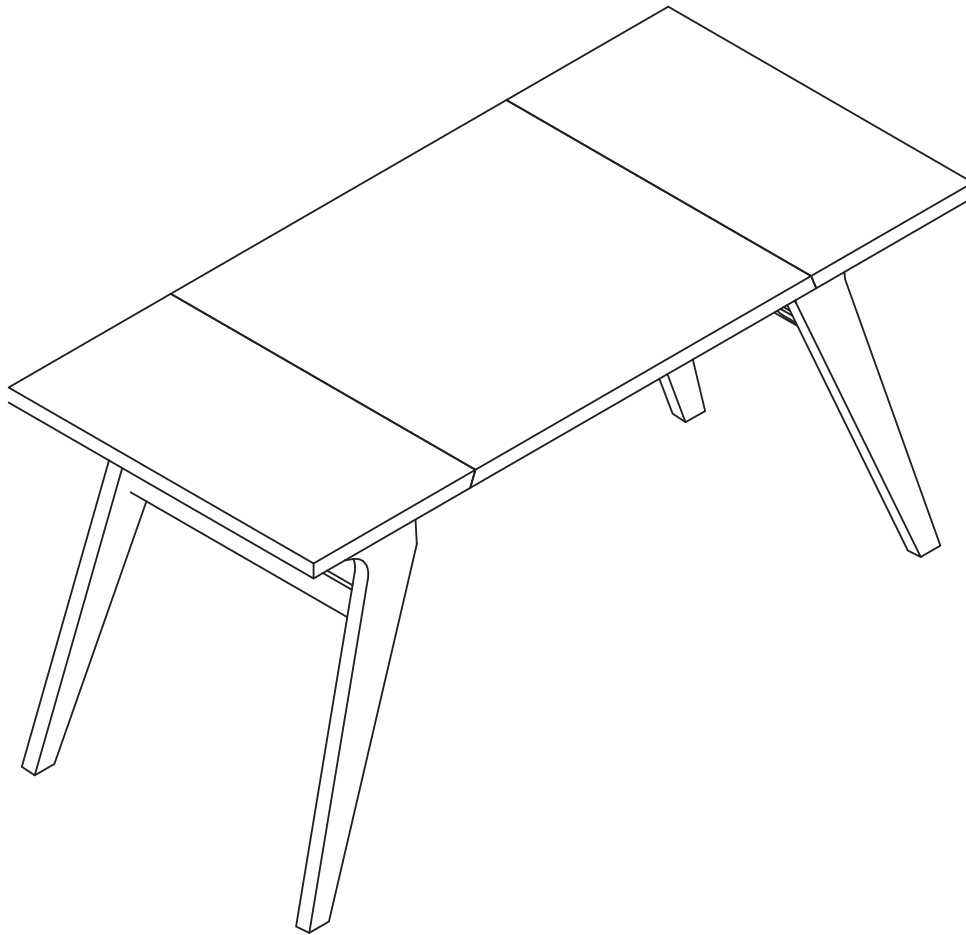

Turn the Table upright carefully with assistance from your adult partners
Exert pressure floorwards, onto the Table with both your hands.
This pressure will help the Legs and Table Top reach full alignment status.
Check for wobbles on a LEVEL surface.

If no wobbles are found proceed to tighten the Bolts in a sequential
manner, until evenly secured.

When tightening the Bolts tighten sequentially.

**Do not tighten any Bolt fully and then move on towards the next one.
If there are still wobbles, loosen the Bolts and execute the same above
process.**

If the Table is not Stable it could lead to damage to the product.

Inspect Table and make sure all parts are adequately connected.
Your Table is ready for use.

This Table can only be used on a flat, level surface.

ASSEMBLY INSTRUCTION

Step 5: When you want to change the product from a dining table to a coffee table, proceed as follows:

5.1-Unlock all the latches underneath the table top

5.2-Fold the left Tabletop down first, ensuring that the edge of the tabletop is in full contact with the floor.

5.3-Next, fold the right tabletop down, making sure it touches the floor and the legs fit together as shown below.

