

# ASSEMBLY INSTRUCTION

This set of products will be shipped in 4 boxes and may arrive on different days.  
If all 4 boxes arrive but parts are missing, please contact customer service.

## Bunkbed 190×90/135cm

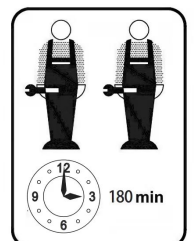
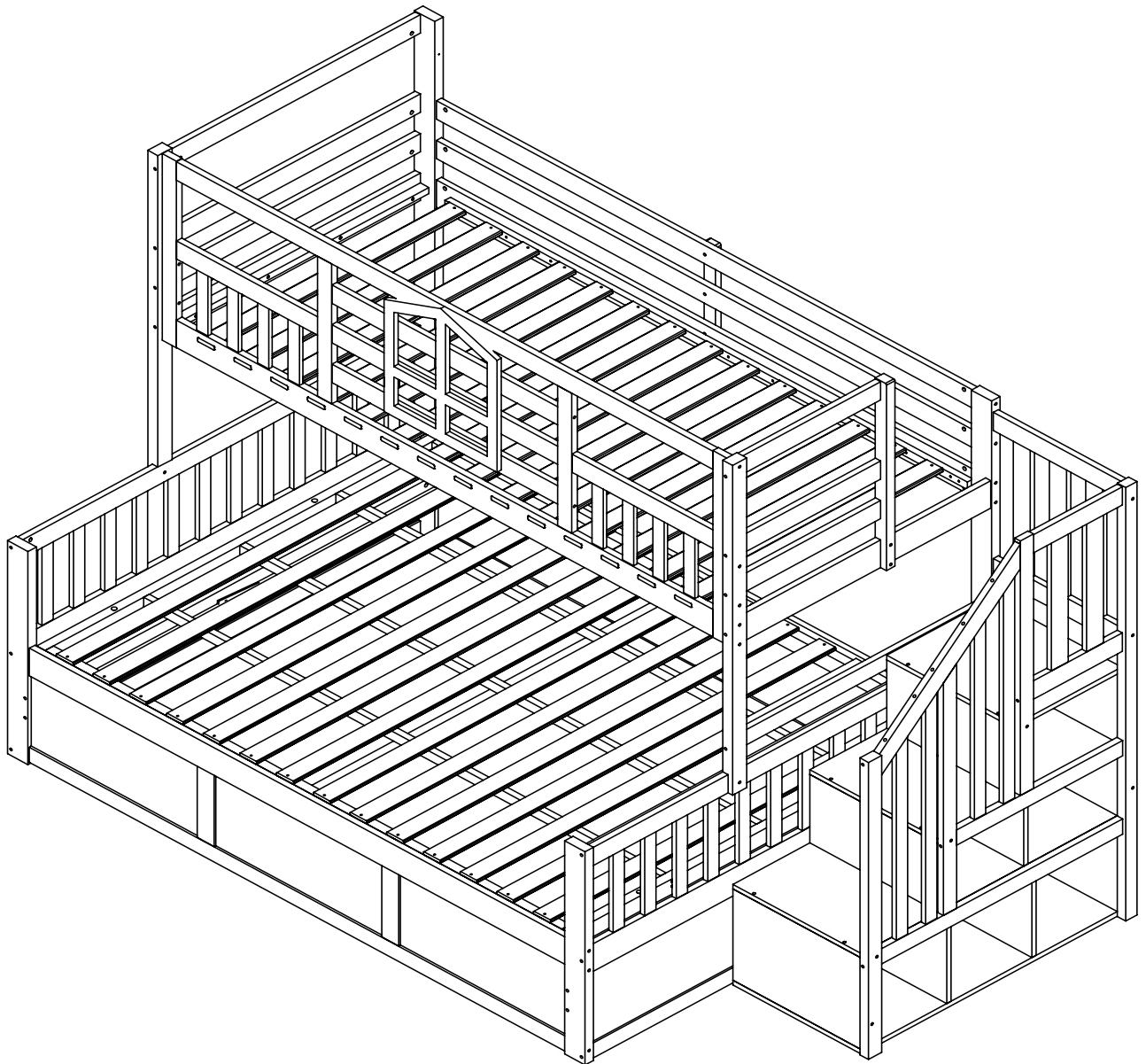

## English

### IMPORTANT FOR GAS LIFT BEDS&MAINTAINANCE

- Please place the mattress on top of the bed frame.
- Please do not pull on the strap handles.
- Please press heavily to release the compressed gas.
- Periodically check all screw & fixings to ensure they are secure.
- When moving your product, carefully lift into place.
- Wipe clean with a slightly damp cloth- please do not use abrasive chemicals or bleach.
- Do NOT allow children to operate the lift mechanism.
- Do NOT allow children near the lift base when operating the mechanism.
- Do NOT stand inside the bed or the internal storage base.
- Do NOT overload the internal storage base.
- DO NOT jump on the product or any of its parts.

## Deutsch

### WICHTIG FÜR GASLIFT-BETTEN&WARTUNG

- Bitte legen Sie die Matratze oben auf den Bettrahmen.
- Bitte ziehen Sie nicht an den Gurtgriffen.
- Bitte drücken Sie kräftig, um das komprimierte Gas freizusetzen.
- Überprüfen Sie regelmäßig alle Schrauben und Befestigungen, um sicherzustellen, dass sie sicher sind.
- Wenn Sie Ihr Produkt bewegen, heben Sie es vorsichtig an seinen Platz.
- Mit einem leicht feuchten Tuch abwischen - bitte keine scheuernden Chemikalien oder Bleichmittel verwenden.
- Erlauben Sie Kindern NICHT, den Hebemechanismus zu bedienen.
- Lassen Sie Kinder NICHT in die Nähe des Liftsockels, wenn Sie den Mechanismus bedienen.
- Stellen Sie sich NICHT in das Bett oder in die Innenablage.
- Überlasten Sie den internen Liftsockel NICHT.
- Springen Sie NICHT auf das Produkt oder eines seiner Teile.

## Français

### IMPORTANT POUR LES LITS À RELEVAGE DE GAZ&MAINTENANCE

- Veuillez placer le matelas sur le dessus du cadre de lit.
- Ne tirez pas sur les poignées de la sangle.
- Appuyez fortement pour libérer le gaz comprimé.
- Vérifiez régulièrement que toutes les vis et fixations sont bien en place.
- Lorsque vous déplacez votre produit, soulevez-le avec précaution pour le mettre en place.
- Nettoyez avec un chiffon légèrement humide - n'utilisez pas de produits chimiques abrasifs ou d'eau de Javel.
- Ne laissez pas les enfants utiliser le mécanisme de levage.
- Ne laissez pas les enfants s'approcher de la base de levage lorsqu'ils actionnent le mécanisme.
- Ne vous tenez PAS à l'intérieur du lit ou de la base de stockage interne.
- Ne surchargez pas la base de stockage interne.
- Ne pas sauter sur le produit ou l'une de ses parties.

## Italiano

### IMPORTANTE PER I LETTI CON SOLLEVAMENTO A GAS E LA MANUTENZIONE

- Posizionare il materasso sopra la struttura del letto.
- Non tirare le maniglie della cinghia.
- Premere con forza per rilasciare il gas compresso.
- Controllare periodicamente tutte le viti e i fissaggi per assicurarsi che siano saldi.
- Quando si sposta il prodotto, sollevarlo con cautela.
- Pulire con un panno leggermente umido, senza usare prodotti chimici abrasivi o candeggina.
- NON permettere ai bambini di azionare il meccanismo di sollevamento.
- NON permettere ai bambini di avvicinarsi alla base di sollevamento quando si aziona il meccanismo.
- NON sostare all'interno del letto o della base di contenimento interna.
- NON sovraccaricare la base di contenimento interna.
- NON saltare sul prodotto o sulle sue parti.

## Español

### IMPORTANTE PARA LAS CAMAS ELEVADORAS DE GAS&MANTENIMIENTO

- Coloque el colchón sobre el somier.
- No tire de las asas de la correa.
- Presione con fuerza para liberar el gas comprimido.
- Compruebe periódicamente que todos los tornillos y fijaciones estén bien sujetos.
- Al mover el producto, levántelo con cuidado para colocarlo en su sitio.
- Limpie con un paño ligeramente humedecido; no utilice productos químicos abrasivos ni lejía.
- NO permita que los niños accionen el mecanismo de elevación.
- NO permita que los niños se acerquen a la base elevadora cuando accionen el mecanismo.
- NO se ponga de pie dentro de la cama o de la base de almacenamiento interna.
- NO sobrecargue el somier.
- NO salte sobre el producto ni sobre ninguna de sus piezas.

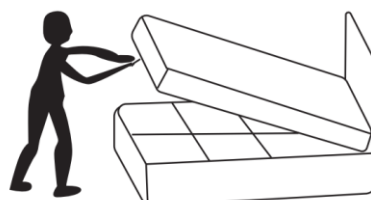

# INSTRUCTIONS

## IMPORTANT-READ CAREFULLY-RETAIN FOR FUTURE REFERENCE

- a) **WARNING** -Children can become trapped between the bed and the wall, the adjoining pieces of furniture (e.g. cupboards) and the like. To avoid risk of serious injury the distance between the safety barrier and the adjoining structure shall not exceed 90 mm or shall be more than 230 mm.
- b) **WARNING**-Do not use the bed if any structural part is broken or missing; Replacement parts are between requested from the manufacturer or the store.
- c) **WARNING**-Do not climb or wiggle on any non-designated structures.
- d) it is imperative to always follow the installation instructions and manufacturer's use.
- e) **The recommended size of the mattress to be used with the bed is 190cmx90/135 cm, maximum thickness mattress:13cm.**
- f) It is necessary to ventilate the room in order to maintain a low level moisture and prevent mold growth in the bed and its periphery.
- g) Joining devices should always be tightened properly and regularly verified. Tighten if necessary.
- i) **Meets European standard requirements NC safety EN 747-1:2024.**

# ANLEITUNGEN

## WICHTIG - SORGFÄLTIG LESEN - FÜR SPÄTERE VERWENDUNG

### AUFBEWAHREN

- a) **WARNUNG** - Kinder können zwischen dem Bett und der Wand, den angrenzenden Möbelstücken (z. B. Schränken) und der Lücke eingeklemmt werden. Um die Gefahr schwerer Verletzungen zu vermeiden, darf der Abstand zwischen der Sicherheitsbarriere und der angrenzenden Struktur nicht mehr als 90 mm oder mehr als 230 mm betragen.
- b) **WARNUNG**-Das Bett darf nicht benutzt werden, wenn ein Bauteil gebrochen ist oder fehlt; Ersatzteile sind beim Hersteller oder im Geschäft anzufordern.
- c) **WARNUNG** - Klettern oder wackeln Sie nicht auf nicht dafür vorgesehenen Strukturen.
- d) Befolgen Sie unbedingt die Installationsanweisungen und die Gebrauchsanweisungen des Herstellers.
- e) **Die empfohlene Größe der Matratze für das Bett beträgt 190cmx90/135 cm, maximale Dicke der Matratze: 13cm.**
- f) Es ist notwendig, den Raum zu lüften, um die Feuchtigkeit niedrig zu halten und Schimmelbildung im Bett und seiner Umgebung zu verhindern.
- g) Die Verbindungselemente sollten immer richtig angezogen sein und regelmäßig überprüft werden. Ziehen Sie sie gegebenenfalls nach.
- i) **Meets European standard requirements NC safety EN 747-1:2024.**

5. Un lit superposé ne doit pas être placé à proximité d'un ventilateur de plafond, à moins que la distance entre les points les plus proches du ventilateur de plafond ne soit respectée. Le lit mesure au moins 2 mètres.
6. Utilisez des garde-corps des deux côtés du lit supérieur.
7. Les enfants doivent jouer raisonnablement dans et autour du lit pour éviter les chutes et les blessures.
8. Le lit est conçu pour une seule personne à chaque niveau.
9. Utilisez l'échelle pour entrer et sortir du lit supérieur.
10. Si le lit superposé doit être placé près du mur, le garde-corps qui s'étend sur toute la longueur du lit doit être placé contre le mur pour éviter tout coincement entre le lit et le mur.
11. AVERTISSEMENT N'utilisez pas le lit superposé/lit surélevé si une pièce structurelle est cassée ou manquante.
12. La ventilation de la pièce est nécessaire afin de maintenir un faible taux d'humidité et d'éviter la moisissure dans et autour du lit.
13. AVERTISSEMENT "les lits hauts et le lit supérieur des lits superposés ne conviennent pas aux enfants de moins de six ans en raison du risque de blessure en cas de chute".
14. AVERTISSEMENT "Les enfants peuvent se retrouver coincés entre le lit et le mur, une pente de toit, le plafond, des meubles attenants (par exemple des placards) et autres. Pour éviter tout risque de blessure grave, la distance entre la barrière de sécurité supérieure et la barrière de sécurité adjacente la structure ne doit pas dépasser 75 mm ni dépasser 230 mm".
15. Ce lit enfant est conforme aux normes BS EN 747- 1 : 2024 et BS EN 747-2 : 2024  
"Meubles - Lits superposés et lits hauts".
16. Suivez toujours les instructions du fabricant.

#### **RISQUE D'ÉTRANGULATION :**

17. N'attachez ou ne suspendez jamais d'objets à une partie du lit superposé qui ne sont pas conçus pour être utilisés avec le lit, par exemple, mais sans s'y limiter, des crochets, des ceintures et des cordes à sauter.
18. AVERTISSEMENT "Les lits superposés et les lits hauts peuvent présenter un risque sérieux de blessure par strangulation s'ils ne sont pas utilisés correctement. N'attachez ou ne suspendez jamais d'objets à une partie du lit superposé qui ne sont pas conçus pour être utilisés avec le lit. par exemple, mais sans s'y limiter, les cordes, ficelles, cordons, crochets, ceintures et sacs".

## **IMPORTANTE- LEER CON ATENCIÓN -**

### **CONSERVAR PARA FUTURA REFERENCIA**

#### **¡MEJORES CONSEJOS ANTES DE COMENZAR!**

1. Verifique que todas las piezas y herrajes estén presentes antes de comenzar a ensamblar sus muebles.
2. Para facilitar y acelerar el montaje, recomendamos que antes de comenzar cada paso del montaje,  
  
Identifique todas las piezas necesarias para ese paso.
3. Recomendamos que, siempre que sea posible, todos los artículos se monten cerca del área en la que se utilizarán.  
  
para evitar mover el producto innecesariamente una vez montado.
4. Para la protección de sus muebles, especialmente los artículos con acabado de alto brillo, recomendamos colocar el producto sobre una  
  
Superficie protegida durante el montaje para evitar cualquier daño.
5. Durante el montaje, tenga cuidado de no apretar demasiado ningún accesorio, ya que esto podría dañar el producto.

#### **CUIDADO Y MANTENIMIENTO DE TUS MUEBLES**

1. Revise periódicamente todos los accesorios y vuelva a apretarlos según sea necesario.
2. Para limpiar su artículo, utilice un paño húmedo y límpielo.
3. Nunca permita que quede ningún tipo de líquido en sus muebles. La absorción puede causar que la madera se deforme o que los acabados se deslaminen.
4. No coloque artículos calientes ( por ejemplo, bebidas calientes) directamente sobre la superficie de madera.
5. No arrastre ni tire de sus muebles.

#### **INFORMACIÓN IMPORTANTE**

1. El tamaño recomendado del colchón: (W)90/135cmx(L)190cmx(H)13cm.
2. Grosor máximo del colchón: **13cm**.
3. Se debe disuadir a los niños de jugar encima de esta litera.
4. El propietario debe revisar periódicamente la litera para garantizar que la barandilla, la escalera y otros componentes se mantengan en la posición y estado correctos y que todos los conectores estén apretados.

5. No se debe colocar una litera cerca de un ventilador de techo a menos que la distancia entre los puntos más cercanos de la litera del ventilador de techo. La cama mide al menos 2 metros.

6. Utilice barandillas a ambos lados de la litera superior.

7. Los niños deben jugar con sensatez dentro y alrededor de la cama para evitar caídas y lesiones.

8. La cama está diseñada para una persona en cada nivel únicamente.

9. Utilice la escalera para entrar y salir de la litera superior.

10. Si la litera se va a colocar junto a la pared, la barandilla que recorre toda la longitud de la cama debe colocarse contra

La pared para evitar atrapamientos entre la cama y la pared.

11. ADVERTENCIA No utilice la litera/cama alta si alguna pieza estructural está rota o falta.

12. La ventilación de la habitación es necesaria para mantener baja la humedad y evitar moho dentro y alrededor de la cama.

13. ADVERTENCIA "Las camas altas y la cama superior de las literas no son adecuadas para niños menores de seis años debido al riesgo de lesiones por caídas".

14. ADVERTENCIA "Los niños pueden quedar atrapados entre la cama y la pared, la pendiente del tejado, el techo, los muebles contiguos (por ejemplo, armarios) y similares. Para evitar el riesgo de lesiones graves, la distancia entre la barrera de seguridad superior y la barrera de seguridad contigua La estructura no excederá los 75 mm ni excederá los 230 mm".

15. Esta cama infantil cumple con BS EN 747-1 : 2024 y BS EN 747-2: 2024.

"Mobiliario - Literas y camas altas".

16. Siga siempre las instrucciones del fabricante.

#### **PELIGRO DE ESTRANGULACIÓN:**

17. Nunca coloque ni cuelgue elementos en ninguna parte de la litera que no estén diseñados para usarse con la cama, por ejemplo, entre otros, ganchos, cinturones y cuerdas para saltar.

18. ADVERTENCIA "Las literas y las camas altas pueden presentar un riesgo grave de lesiones por estrangulamiento si no se usan correctamente. Nunca fije ni cuelgue elementos en ninguna parte de la litera que no estén diseñados para usarse con la cama, por ejemplo, pero no limitado a cuerdas, cordeles, cordones, ganchos, cinturones y bolsas".

## **IMPORTANTE - LEGGERE ATTENTAMENTE -**

### **CONSERVARE PER RIFERIMENTO FUTURO**

#### **I MIGLIORI CONSIGLI PRIMA DI INIZIARE!**

1. Verificare che tutte le parti e l'hardware siano presenti prima di iniziare l'assemblaggio dei mobili.
2. Per facilitare e velocizzare l'assemblaggio, si consiglia prima di iniziare ogni fase dell'assemblaggio, identificare tutte le parti necessarie per questo passaggio.
3. Raccomandiamo, ove possibile, che tutti gli articoli siano assemblati vicino all'area in cui verranno utilizzati, per evitare di spostare inutilmente il prodotto una volta assemblato.
4. Per la protezione dei tuoi mobili, in particolare degli articoli con finitura lucida, ti consigliamo di posizionare il prodotto su una superficie protetta durante il montaggio per evitare eventuali danni.
5. Durante il montaggio fare attenzione a non stringere eccessivamente i raccordi, poiché ciò potrebbe danneggiare il prodotto.

#### **CURA E MANUTENZIONE DEI VOSTRI MOBILI**

1. Controllare periodicamente tutti i raccordi e serrarli nuovamente se necessario.
2. Per pulire l'articolo, utilizzare un panno umido e pulirlo.
3. Non lasciare mai alcun tipo di liquido sui mobili. L'assorbimento può causare la deformazione del legno o la delaminazione delle finiture.
4. Si prega di non posizionare oggetti caldi (ad esempio bevande calde) direttamente sulla superficie del legno.
5. Si prega di non trascinare o tirare i mobili.

#### **INFORMAZIONI IMPORTANTI**

1. Dimensioni consigliate del materasso: (L)135/90cm x (L)190cm x (H) 13 cm.
2. Spessore massimo del materasso: **13cm**.
3. I bambini dovrebbero essere scoraggiati dal giocare sul letto a castello.
4. Il letto a castello deve essere controllato periodicamente dal proprietario per garantire che il parapetto, la scala e gli altri componenti siano mantenuti nella posizione corretta e in stato di riparazione e che tutti i connettori siano serrati.
5. Un letto a castello non deve essere posizionato vicino a un ventilatore da soffitto, a meno che non sia rispettata la distanza tra i punti più vicini sul letto a castello. Il letto è di almeno 2 metri.

6. Utilizzare le sponde su entrambi i lati del letto superiore.
7. I bambini dovrebbero giocare in modo sensato dentro e intorno al letto per evitare cadute e lesioni.
8. Il letto è previsto per una sola persona su ogni livello.
9. Usa la scala per entrare e uscire dalla cuccetta superiore.
10. Se il letto a castello verrà posizionato vicino al muro, la ringhiera che corre per tutta la lunghezza del letto deve essere posizionata contro  
Il muro per evitare intrappolamenti tra il letto e il muro.
11. **ATTENZIONE** Non utilizzare il letto a castello/letto sopraelevato se qualche parte strutturale è rotta o mancante.
12. La ventilazione della stanza è necessaria per mantenere bassa l'umidità e prevenire la formazione di muffe all'interno e attorno al letto.
13. **ATTENZIONE** "I letti alti e il letto superiore dei letti a castello non sono adatti a bambini di età inferiore a sei anni a causa del rischio di lesioni dovute a cadute".
14. **AVVERTENZA** "I bambini possono rimanere intrappolati tra il letto e il muro, la falda del tetto, il soffitto, i mobili adiacenti (ad esempio armadi) e simili. Per evitare il rischio di lesioni gravi, la distanza tra la barriera di sicurezza superiore e quella adiacente la struttura non deve superare i 75 mm né essere superiore ai 230 mm".
15. Questo lettino è conforme alle norme BS EN 747-1 : 2024 e BS EN 747-2: 2024  
"Mobili - Letti a castello e letti alti".
16. Seguire sempre le istruzioni del produttore.

**PERICOLO DI STRANGOLAMENTO:**

17. Non attaccare o appendere mai oggetti a qualsiasi parte del letto a castello che non siano progettati per l'uso con il letto, ad esempio, ma non limitati a ganci, cinture e corde per saltare.
18. **AVVERTENZA** "I letti a castello e i letti alti possono presentare un grave rischio di lesioni da strangolamento se non utilizzati correttamente. Non attaccare o appendere mai oggetti a qualsiasi parte del letto a castello che non siano progettati per essere utilizzati con il letto, ad esempio, ma non limitato a corde, spaghi, corde, ganci, cinture e borse".

## **IMPORTANT- READ CAREFULLY-**

### **RETAIN FOR FUTURE REFERENCE**

#### **TOP TIPS BEFORE YOU START !**

1. Please check that all parts & hardware are present before you start the assembly of your furniture.
2. For ease and speed of assembly, we recommend that before you commence each step of the assembly,  
  
Please identify all the parts required for that step.
3. We recommend that where possible, all items are assembled near to the area in which they will be placed in use,  
  
to avoid moving the product unnecessarily once assembled.
4. For the protection of your furniture, particularly items of high gloss finish, we recommend that the product is placed on a  
  
Protected surface during assembly to prevent any damage.
5. During assembly please take care not to over-tighten any fittings, as this may damage the product.

#### **CARE AND MAINTENANCE OF YOUR FURNITURE**

1. Please periodically check all fittings and re-tighten as necessary.
2. To clean your item, please use a damp cloth and wipe clean.
3. Never allow any kind of liquid to remain on your furniture. Absorption can cause wood to warp or finishes to de-laminate.
4. Please do not place hot items (e.g hot drinks) directly on the wood surface.
5. Please do not drag or pull your furniture.

#### **IMPORTANT INFORMATION**

1. The recommended size of mattress: (W)90/135cmx(L)190cmx(H)13cm.
2. Maximum thickness of mattress: **13cm**.
3. Children should be discouraged from playing on top of this bunk bed.
4. The bunk bed should be checked periodically by the owner to ensure that the guardrail, ladder, and other components are maintained in the correct position and state of repair and that all connectors are tight.
5. A bunk bed is not to be placed near a ceiling fan unless the distance between the closest points on the ceiling fan bunk. Bed is at least 2 metres.
6. Use guardrails on both sides of upper bunk.

7. Children should play sensibly in and around the bed to avoid falling and injury.
8. The bed is designed for one person on each level only.
9. Use Ladder for entering and leaving upper bunk.
10. If the bunk bed will be placed next to the wall, the guardrail that runs the full length of the bed should be placed against

The wall to prevent entrapment between the bed and the wall.

11. WARNING Do not use the bunk bed/high bed if any structural part is broken or missing.
12. Ventilation of the room is necessary in order to keep the humidity low and to prevent mould in and around the bed.
13. WARNING "high beds & the upper bed of bunk beds are not suitable for children under six years due to risk of injury from falls".
14. WARNING "children can become trapped between the bed & the wall, a roof pitch, the ceiling, adjoining pieces of furniture (e.g. cupboards) and the like. To avoid risk of serious injury the distance between the top safety barrier and the adjoining structure shall not exceed 75mm nor shall be more than 230mm".
15. This child bed conforms to BS EN 747-1 : 2024 & BS EN 747-2 : 2024  
"Furniture - Bunk beds and high beds".
16. Always follow the manufacturer's instructions.

**STRANGULATION HAZARD:**

17. Never attach or hang items to any part of the bunk bed that are not designed for use with the bed for example, but not limited to hooks, belts and jump ropes.
18. WARNING "Bunk Beds and high beds can present a serious risk of injury from strangulation if not used correctly. Never attach or hang items to any part of the bunk bed that are not designed to be used with the bed. for example, but not limited to ropes, strings, cords, hooks, belts and bags".

# **WICHTIG - SORGFÄLTIG LESEN - FÜR SPÄTERE VERWENDUNG AUFBEWAHREN**

## **TOP-TIPPS, BEVOR SIE STARTEN!**

1. Bitte überprüfen Sie, ob alle Teile und Beschläge vorhanden sind, bevor Sie mit der Montage Ihrer Möbel beginnen.
2. Für eine einfache und schnelle Montage empfehlen wir, dass Sie vor jedem Montageschritt Bitte identifizieren Sie alle für diesen Schritt erforderlichen Teile.
3. Wir empfehlen, alle Artikel möglichst in der Nähe des Einsatzortes zu montieren.  
um ein unnötiges Bewegen des Produkts nach der Montage zu vermeiden.
4. Zum Schutz Ihrer Möbel, insbesondere von Möbeln mit Hochglanzoberfläche, empfehlen wir, das Produkt auf einen Geschützte Oberfläche während der Montage um eventuelle Beschädigungen zu vermeiden.
5. Achten Sie bei der Montage darauf, die Verschraubungen nicht zu fest anzuziehen, da dies zu einer Beschädigung des Produkts führen kann.

## **PFLEGE UND WARTUNG IHRER MÖBEL**

1. Bitte überprüfen Sie regelmäßig alle Verschraubungen und ziehen Sie sie bei Bedarf nach.
2. Verwenden Sie zum Reinigen Ihres Artikels bitte ein feuchtes Tuch und wischen Sie ihn sauber.
3. Lassen Sie niemals Flüssigkeiten auf Ihren Möbeln zurück. Durch die Aufnahme kann sich das Holz verziehen oder die Oberfläche kann sich ablösen.
4. Bitte stellen Sie keine heißen Gegenstände ( z. B. heiße Getränke) direkt auf die Holzoberfläche.
5. Bitte schleifen oder ziehen Sie Ihre Möbel nicht.

## **WICHTIGE INFORMATIONEN**

1. Die empfohlene Matratzengröße: (B)90/135cmx(L)190cmx(H)13m.
2. Maximale Matratzendicke: 13cm.
3. Kinder sollten davon abgehalten werden, auf diesem Etagenbett zu spielen.
4. Das Etagenbett sollte regelmäßig vom Eigentümer überprüft werden, um sicherzustellen, dass Geländer, Leiter und andere Komponenten in der richtigen Position und im richtigen Zustand gehalten werden und dass alle Verbindungselemente fest sind.
5. Ein Etagenbett darf nicht in der Nähe eines Deckenventilators aufgestellt werden, es sei denn, der Abstand zwischen den nächstgelegenen Punkten des Etagenbetts mit Deckenventilator beträgt mindestens 2 Meter.

6. Verwenden Sie an beiden Seiten der oberen Koje Schutzgeländer.
7. Kinder sollten vernünftig im und um das Bett spielen, um Stürze und Verletzungen zu vermeiden.
8. Das Bett ist auf jeder Ebene nur für eine Person ausgelegt.
9. Benutzen Sie die Leiter zum Ein- und Aussteigen aus dem oberen Bett.
10. Wenn das Etagenbett neben der Wand aufgestellt wird, sollte das über die gesamte Länge des Bettes verlaufende Schutzgeländer gegen  
Die Wand verhindert ein Einklemmen zwischen Bett und Wand.
11. **WARNUNG** Verwenden Sie das Etagenbett/Hochbett nicht, wenn ein Bauteil gebrochen ist oder fehlt.
12. Eine Belüftung des Zimmers ist notwendig, um die Luftfeuchtigkeit niedrig zu halten und Schimmelbildung im und um das Bett vorzubeugen.
13. **WARNUNG** „Hochbetten & das Oberbett von Etagenbetten sind wegen Verletzungsgefahr durch Stürze nicht für Kinder unter sechs Jahren geeignet.“
14. **WARNUNG:** „Kinder können zwischen Bett und Wand, einer Dachschräge, der Decke, angrenzenden Möbelstücken (z. B. Schränken) und dergleichen eingeklemmt werden. Um die Gefahr schwerer Verletzungen zu vermeiden, darf der Abstand zwischen der oberen Sicherheitsbarriere und der angrenzenden Struktur 75 mm nicht überschreiten und nicht mehr als 230 mm betragen.“
15. Dieses Kinderbett entspricht BS EN 747- 1 : 2024 & BS EN 747-2 : 2024  
"Möbel - Etagenbetten und Hochbetten".
16. Befolgen Sie immer die Anweisungen des Herstellers.

#### **STRANGULATIONSGEFAHR:**

17. Befestigen oder hängen Sie niemals Gegenstände an Teilen des Etagenbetts auf, die nicht für die Verwendung mit dem Bett vorgesehen sind (z. B. Haken, Gürtel und Springseile).
18. **WARNUNG** „Bei unsachgemäßer Verwendung von Etagenbetten und Hochbetten besteht die Gefahr einer Strangulation. Befestigen oder hängen Sie niemals Gegenstände an Teilen des Etagenbetts auf, die nicht für die Verwendung mit dem Bett vorgesehen sind. Dies sind beispielsweise , jedoch nicht ausschließlich, Seile, Schnüre, Kordeln, Haken, Gürtel und Taschen.“

# **IMPORTANT- À LIRE ATTENTIVEMENT- À CONSERVER POUR RÉFÉRENCE FUTURE**

## **LES BONS CONSEILS AVANT DE COMMENCER !**

1. Veuillez vérifier que toutes les pièces et le matériel sont présents avant de commencer l'assemblage de vos meubles.
2. Pour faciliter et accélérer l'assemblage, nous vous recommandons, avant de commencer chaque étape de l'assemblage,

Veuillez identifier toutes les pièces requises pour cette étape.

3. Nous recommandons que, dans la mesure du possible, tous les articles soient assemblés à proximité de la zone dans laquelle ils seront utilisés,

pour éviter de déplacer inutilement le produit une fois assemblé.

4. Pour la protection de vos meubles, en particulier des articles à finition brillante, nous vous recommandons de placer le produit sur un

Surface protégée lors du montage pour éviter tout dommage.

5. Lors de l'assemblage, veillez à ne pas trop serrer les raccords, car cela pourrait endommager le produit.

## **SOIN ET ENTRETIEN DE VOS MEUBLES**

1. Veuillez vérifier périodiquement tous les raccords et resserrer si nécessaire.
2. Pour nettoyer votre article, veuillez utiliser un chiffon humide et essuyer.
3. Ne laissez jamais aucun type de liquide rester sur vos meubles. L'absorption peut provoquer la déformation du bois ou le délaminage des finitions.
4. Veuillez ne pas placer d'objets chauds ( par exemple des boissons chaudes) directement sur la surface du bois.
5. Veuillez ne pas traîner ou tirer vos meubles.

## **UNE INFORMATION IMPORTANT**

1. La taille recommandée du matelas : (L)90/135cmx(L)190cmx(H)13cm.
2. Épaisseur maximale du matelas : **13cm**.
3. Il convient de décourager les enfants de jouer sur ce lit superposé.
4. Le lit superposé doit être vérifié périodiquement par le propriétaire pour s'assurer que le garde-corps, l'échelle et les autres composants sont maintenus dans la bonne position et en bon état et que tous les connecteurs sont bien serrés.

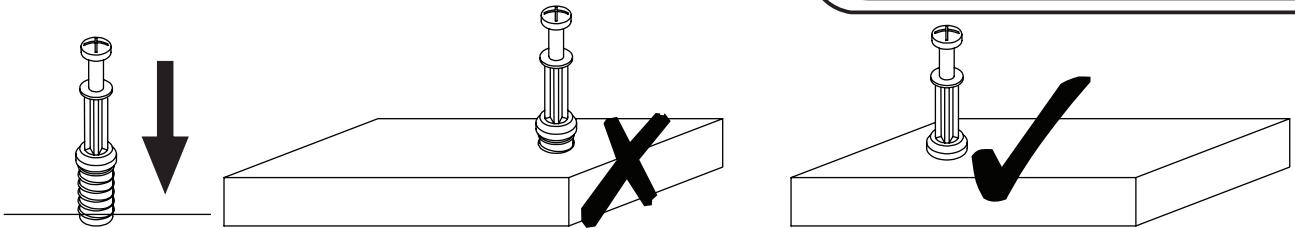

**EN\_QUICKFIT:** Tighten quickfit until shoulder is flush with panel. Do not overtighten or undertighten.

**FR\_RACCORD RAPIDE:** Faites serrer le raccord rapide jusqu'à ce que l'épaulement soit parfaitement encastré dans le panneau. Il ne faut ni trop serrer ni insuffisamment serrer.

**ES\_QUICKFIT:** Apriete quickfit hasta que el hombro se descargue con el panel. NO lo sobreapriete ni lo apriete poco.

**DE\_QUICKFIT:** Ziehen Sie den Quickfit fest, bis die Schulter mit der Platte bündig ist. Bitte nicht zu fest oder zu schwach anziehen.

**IT\_MONTAGGIO RAPIDO:** Stringere il montaggio rapido fino a quando la spalla è a filo con il pannello, non stringere troppo o troppo poco.

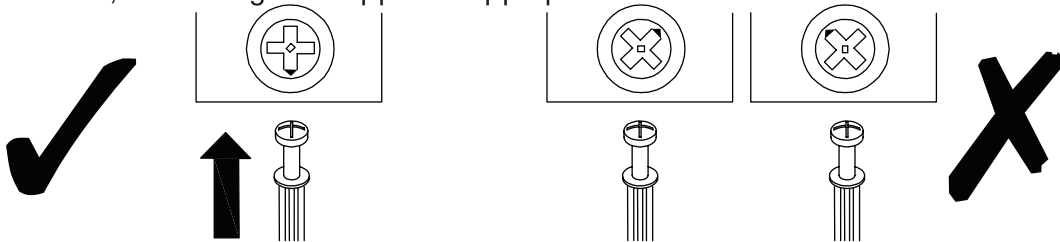

**EN\_CAM LOCK:** When fitting cam lock, ensure starting position is correct before you insert connecting quickfit.

**FR\_SERRURE BATTEUSE:** Avant d'insérer la serrure batteuse, veillez à la bonne orientation avant d'insérer le raccord rapide.

**ES\_CIERRE DE LA CÁMARA:** Cuando instale el cierre de la cámara, asegúrese de que la posición de inicio es correcta antes de que inserte el quickfit conector.

**DE\_CAM-LOCK:** Achten Sie bei der Montage des Cam-Locks auf die richtige Ausgangsposition, bevor Sie den Quickfit einsetzen.

**IT\_BLOCCAGGIO A CAMMA:** Quando si monta il bloccaggio a camma, assicurarsi che la posizione iniziale sia corretta prima di inserire il montaggio rapido di collegamento.

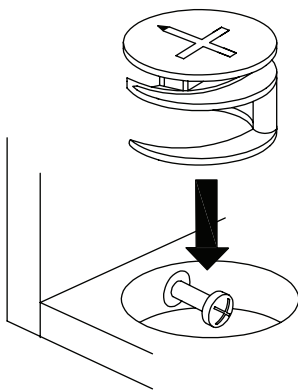

**EN\_Quickfit head** should be in the centre of the cam lock when the two panels are joined.

Cam lock should be inserted before quickfit.

**FR\_Lorsque** les deux panneaux sont assemblés, la tête du raccord rapide doit reposer au centre de la serrure batteuse. Il faut insérer la serrure batteuse avant le raccord rapide.

**ES\_El** cabezal del quickfit debe estar en el centro del cierre de la cámara cuando se unan los dos paneles.

Se debe insertar el cierre de la cámara antes que el quickfit.

**DE\_Der** Quickfit-Kopf sollte sich in der Mitte des Cam-Locks befinden, wenn die beiden Platten zusammengefügt sind. Der Cam-Lock sollte vor dem Quickfit eingesetzt werden.

**IT\_La** testa del montaggio rapido deve trovarsi al centro del bloccaggio a camma quando i due pannelli sono uniti.

Il Bloccaggio a Camma deve essere inserito prima del montaggio rapido.

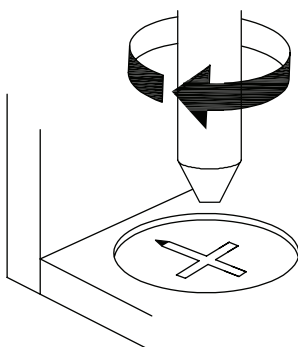

**EN\_Turn** cam lock clockwise to tighten.

**FR\_Faites** tourner la serrure batteuse dans le sens des aiguilles d'une montre pour la resserrer.







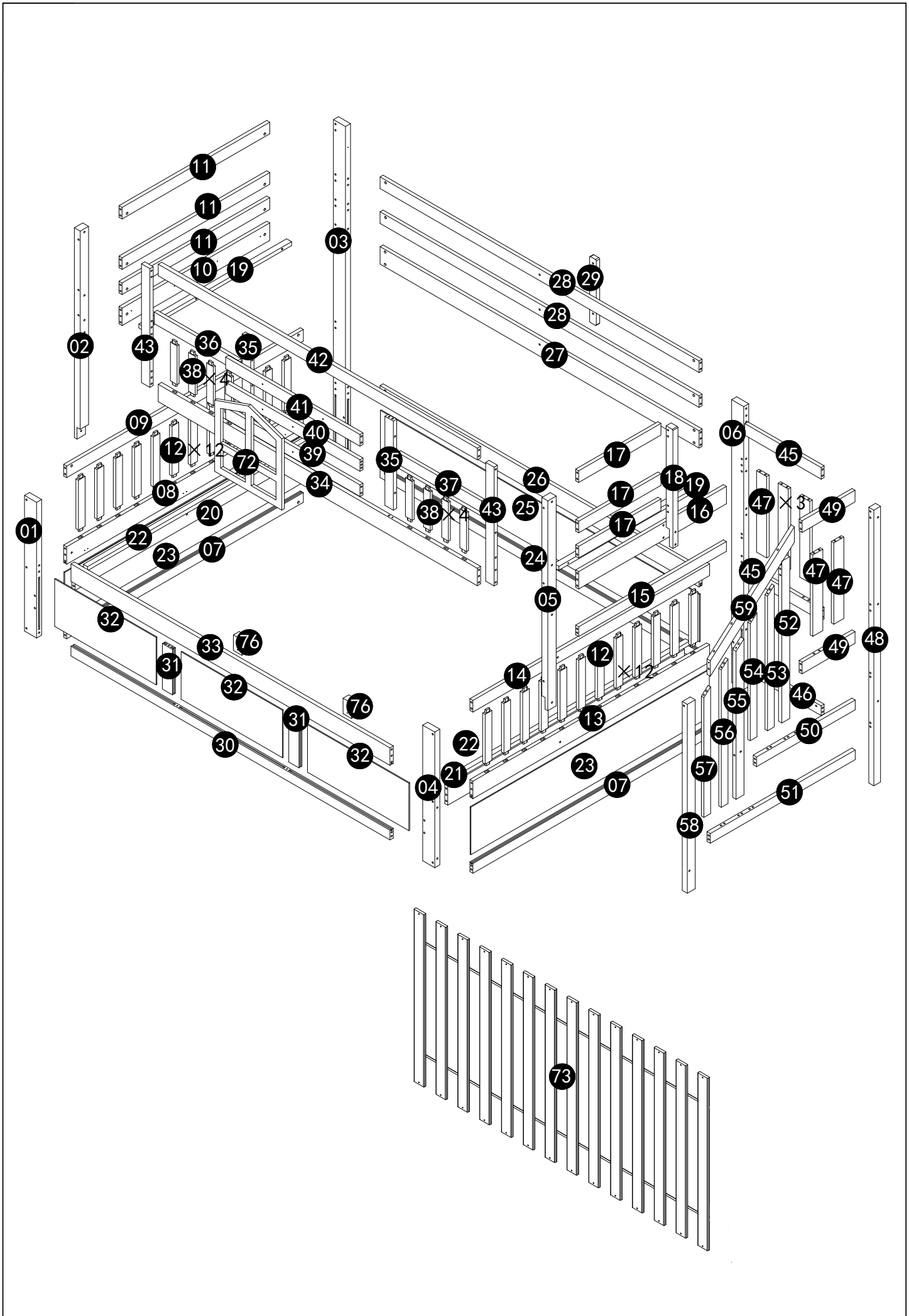

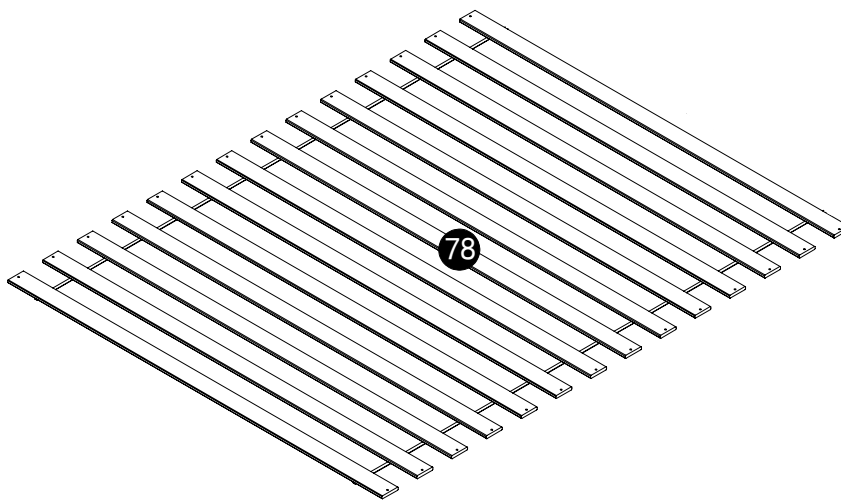
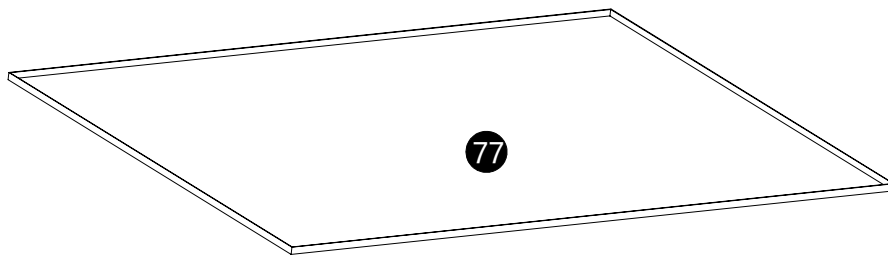
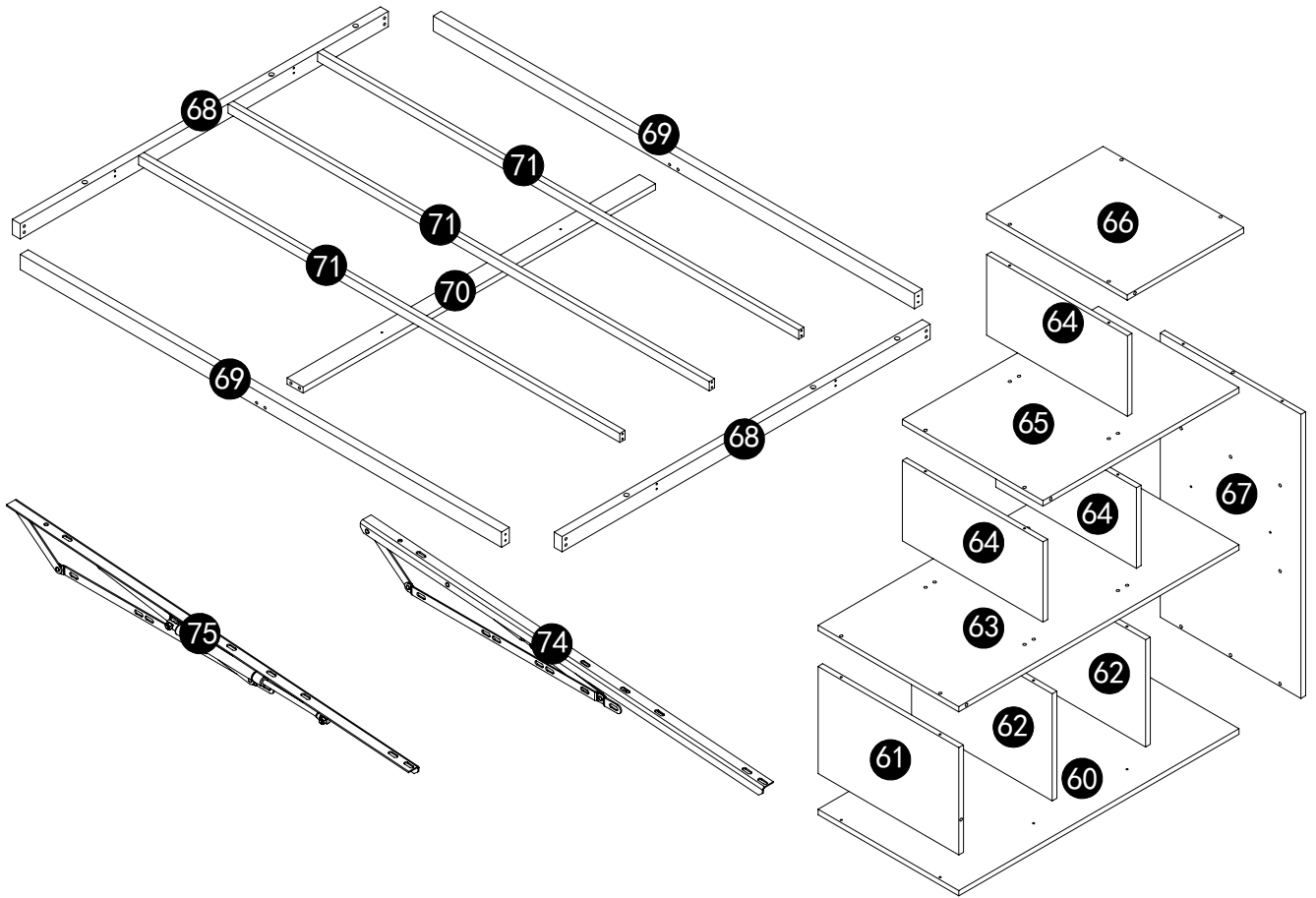
**ES\_Gire** el cierre de la cámara en sentido horario para apretarlo.

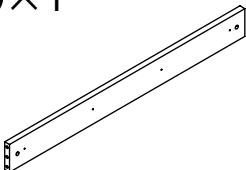
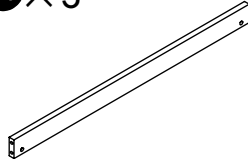
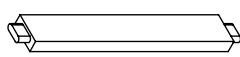
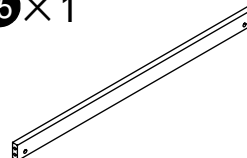
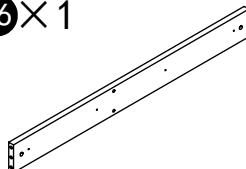
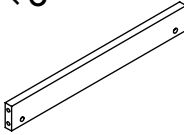
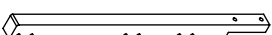
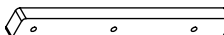
**DE\_Drehen** Sie den Cam-Lock im Uhrzeigersinn, um ihn festzuziehen.

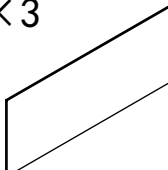
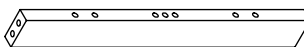
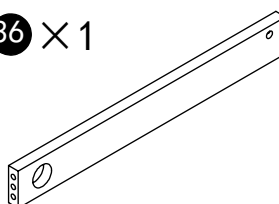
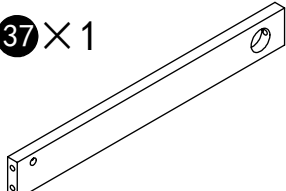
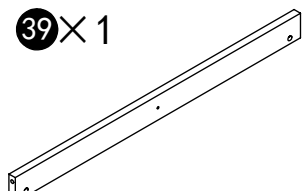
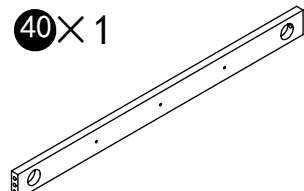
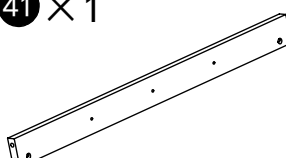
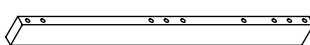
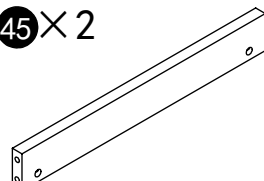
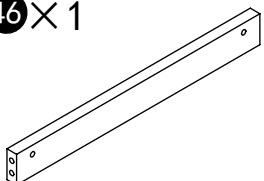

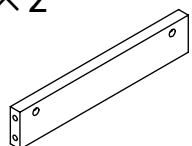
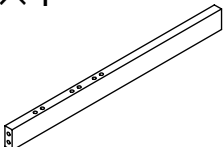

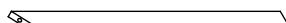
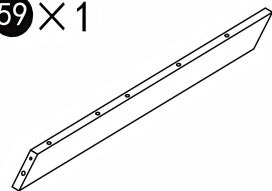
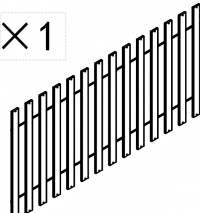





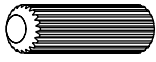

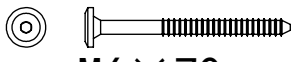
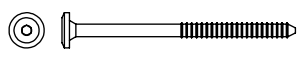
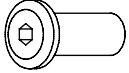
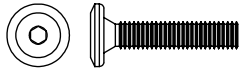

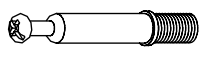
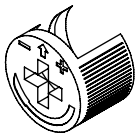

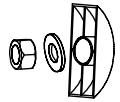
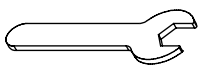
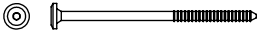
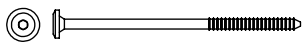
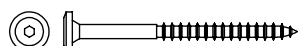

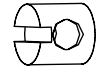
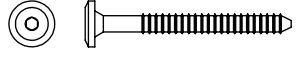
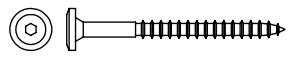

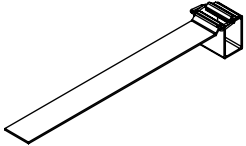
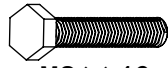
**IT\_Ruotare** il bloccaggio a camma in senso orario per stringere.



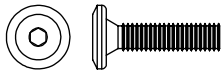
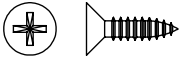
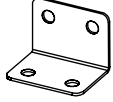

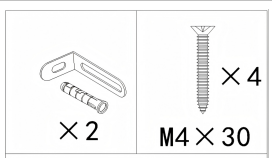

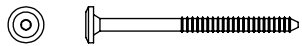
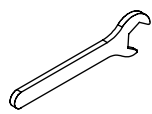

<b>10</b> × 1 	<b>11</b> × 3 	<b>12</b> × 24 	<b>15</b> × 1 
<b>16</b> × 1 	<b>17</b> × 3 	<b>18</b> × 1 	<b>29</b> × 1 
<b>31</b> × 2 	<b>32</b> × 3 	<b>35</b> × 2 	<b>36</b> × 1 
<b>37</b> × 1 	<b>39</b> × 1 	<b>40</b> × 1 	<b>41</b> × 1 
<b>43</b> × 2 	<b>45</b> × 2 	<b>46</b> × 1 	<b>47</b> × 5 
<b>49</b> × 2 	<b>50</b> × 1 	<b>52</b> × 1 	<b>54</b> × 1 
<b>57</b> × 1 	<b>59</b> × 1 	<b>73</b> × 1 	<b>77</b> × 1 

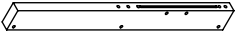
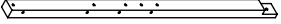
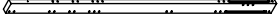
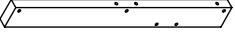
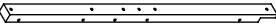
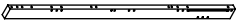
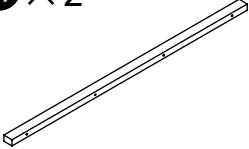
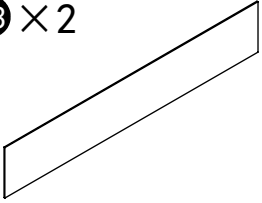
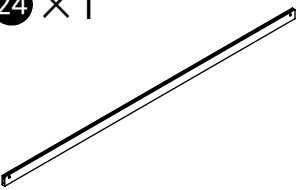
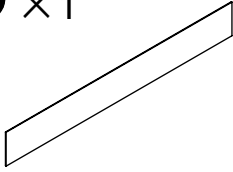
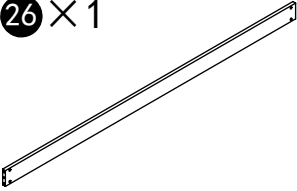
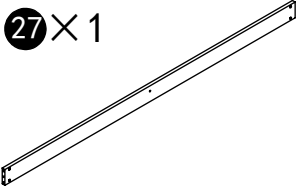
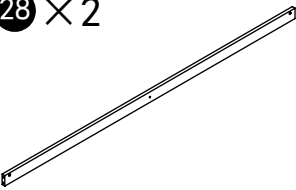
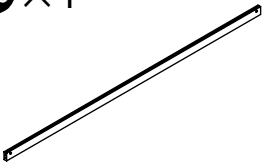
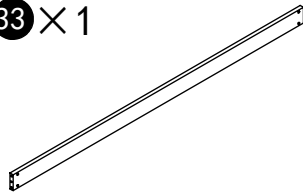
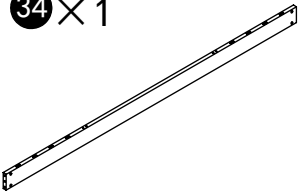
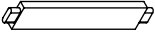
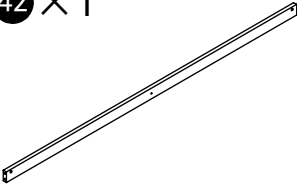
# Hardware-Liste

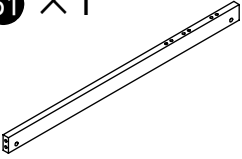
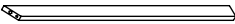
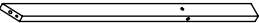
 $\phi 8 \times 30$ <b>A</b> $\times$ 136pcs	 $\phi 10 \times 13$ <b>B</b> $\times$ 88pcs	 <b>M6</b> $\times$ 70 <b>C</b> $\times$ 42pcs	 <b>M6</b> $\times$ 90 <b>D</b> $\times$ 19pcs
 $\phi 6 \times 20$ <b>E</b> $\times$ 11pcs	 <b>M6</b> $\times$ 30 <b>F</b> $\times$ 5pcs	 $\phi 4 \times 40$ <b>G</b> $\times$ 11pcs	 <b>H</b> $\times$ 8pcs
 <b>I</b> $\times$ 8pcs	 <b>M6</b> $\times$ 140 <b>J</b> $\times$ 2pcs	 <b>K</b> $\times$ 4pcs	 <b>L</b> $\times$ 2pcs
 <b>M6</b> $\times$ 110 <b>M</b> $\times$ 23pcs	 <b>M6</b> $\times$ 120 <b>N</b> $\times$ 6pcs	 $\phi 6 \times 80$ <b>O</b> $\times$ 13pcs	 $\phi 7 \times 50$ <b>P</b> $\times$ 32pcs
 $\phi 10 \times 10$ <b>Q</b> $\times$ 5pcs	 <b>M6</b> $\times$ 60 <b>R</b> $\times$ 3pcs	 $\phi 6 \times 70$ <b>S</b> $\times$ 8pcs	 $\phi 4 \times 50$ <b>T</b> $\times$ 16pcs
 <b>U</b> $\times$ 1pcs	 <b>M8</b> $\times$ 40 <b>V</b> $\times$ 6pcs	 <b>W</b> $\times$ 12pcs	 <b>X</b> $\times$ 2pcs
 <b>M8</b> $\times$ 65 <b>Y</b> $\times$ 6pcs	 <b>M6</b> $\times$ 25 <b>Z</b> $\times$ 2pcs	 $\phi 3.5 \times 14$ <b>AA</b> $\times$ 24pcs	 <b>AB</b> $\times$ 6pcs
 $\phi 4 \times 30$ <b>AC</b> $\times$ 10pcs	 $\phi 3 \times 30$ <b>AD</b> $\times$ 56pcs	 $\times 2$ $\times 4$ <b>M4</b> $\times$ 30 <b>AE</b>	 <b>AF</b> $\times$ 4pcs
 <b>M6</b> $\times$ 80 <b>AG</b> $\times$ 4pcs	 <b>AH</b> $\times$ 1pcs	 <b>AI</b> $\times$ 2pcs	

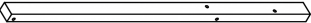
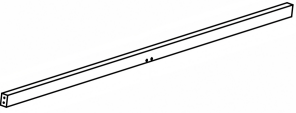
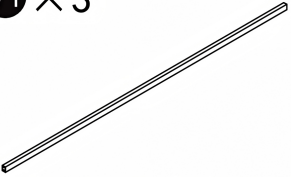
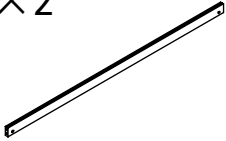
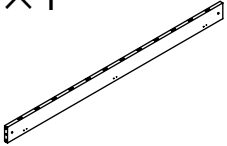
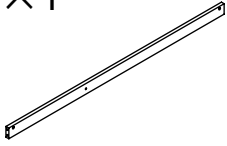
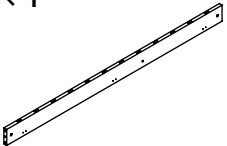
<b>01</b> × 1 	<b>02</b> × 1 	<b>03</b> × 1 	<b>04</b> × 1 
<b>05</b> × 1 	<b>06</b> × 1 	<b>19</b> × 2 	<b>23</b> × 2 
<b>24</b> × 1 	<b>25</b> × 1 	<b>26</b> × 1 	<b>27</b> × 1 
<b>28</b> × 2 	<b>30</b> × 1 	<b>33</b> × 1 	<b>34</b> × 1 
<b>38</b> × 8 	<b>42</b> × 1 	<b>48</b> × 1 	<b>51</b> × 1 
<b>53</b> × 1 	<b>55</b> × 1 	<b>56</b> × 1 	<b>58</b> × 1 
<b>69</b> × 2 	<b>71</b> × 3 		
<b>07</b> × 2 	<b>08</b> × 1 	<b>09</b> × 1 	<b>13</b> × 1 

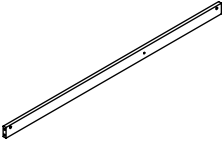
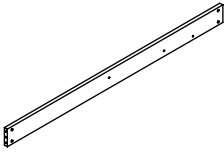
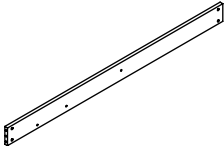
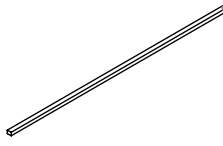
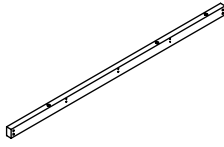
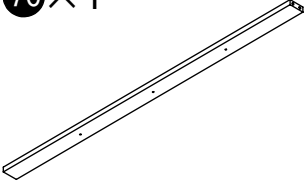
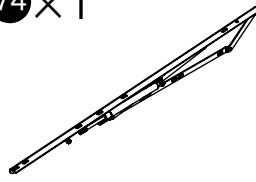
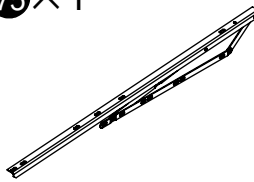
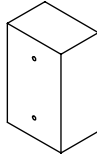
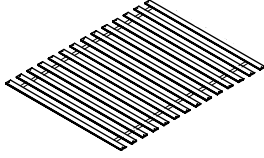
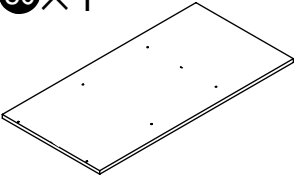
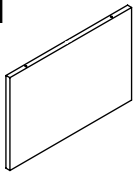
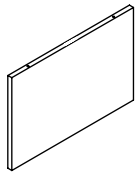
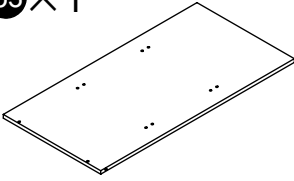
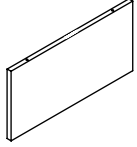
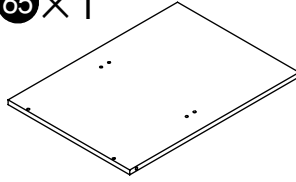
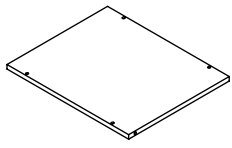
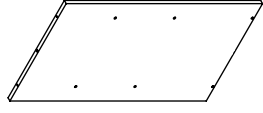
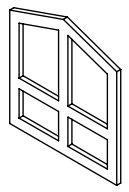
<p>14 × 1</p> 	<p>20 × 1</p> 	<p>21 × 1</p> 	<p>22 × 2</p> 
<p>68 × 2</p> 	<p>70 × 1</p> 	<p>74 × 1</p> 	<p>75 × 1</p> 
<p>76 × 2</p> 	<p>78 × 1</p> 		
<p>60 × 1</p> 	<p>61 × 1</p> 	<p>62 × 2</p> 	<p>63 × 1</p> 
<p>64 × 3</p> 	<p>65 × 1</p> 	<p>66 × 1</p> 	<p>67 × 1</p> 
<p>72 × 1</p> 			

1

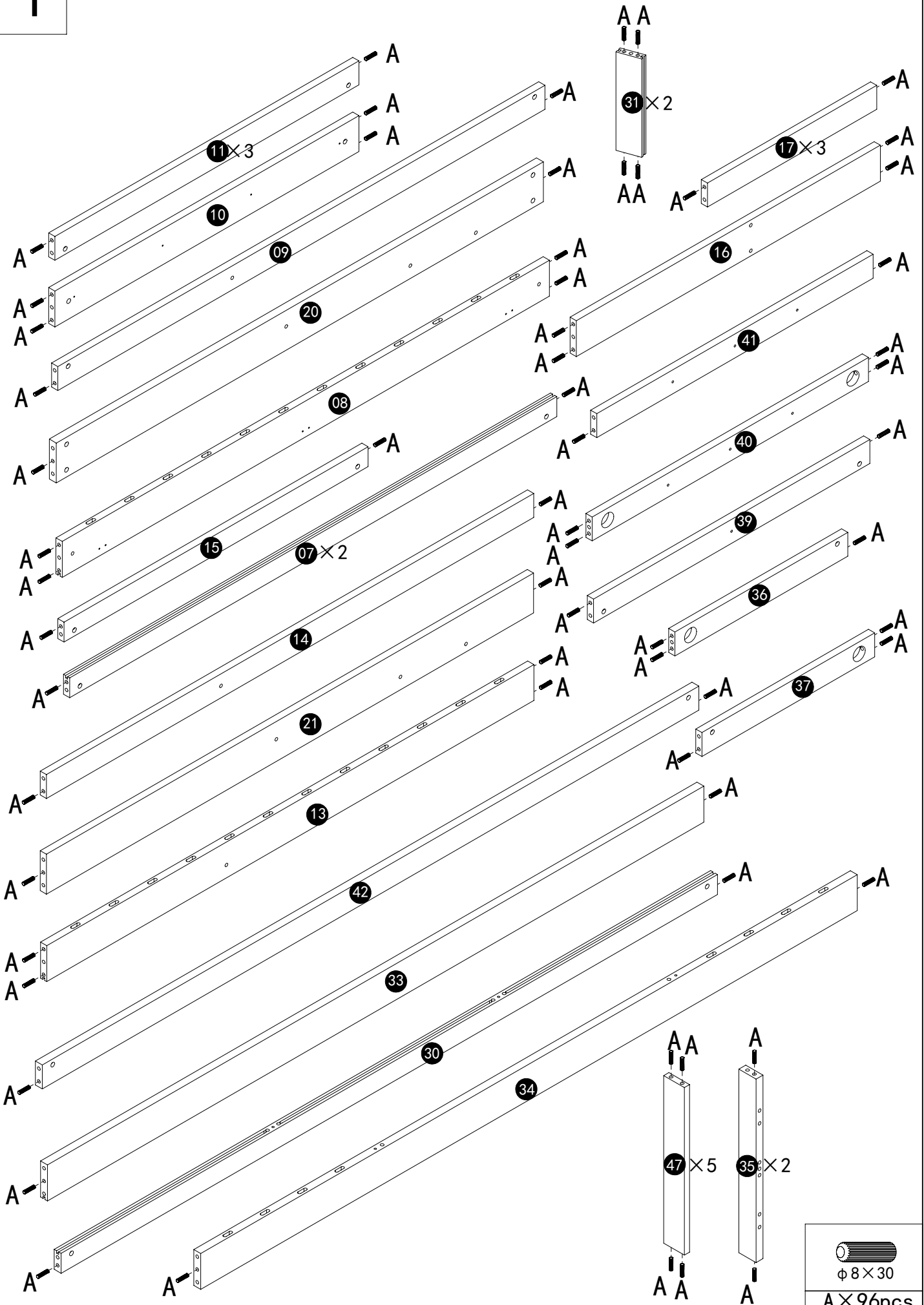

  
φ 8 × 30  
A × 96 pcs

2

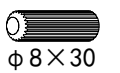
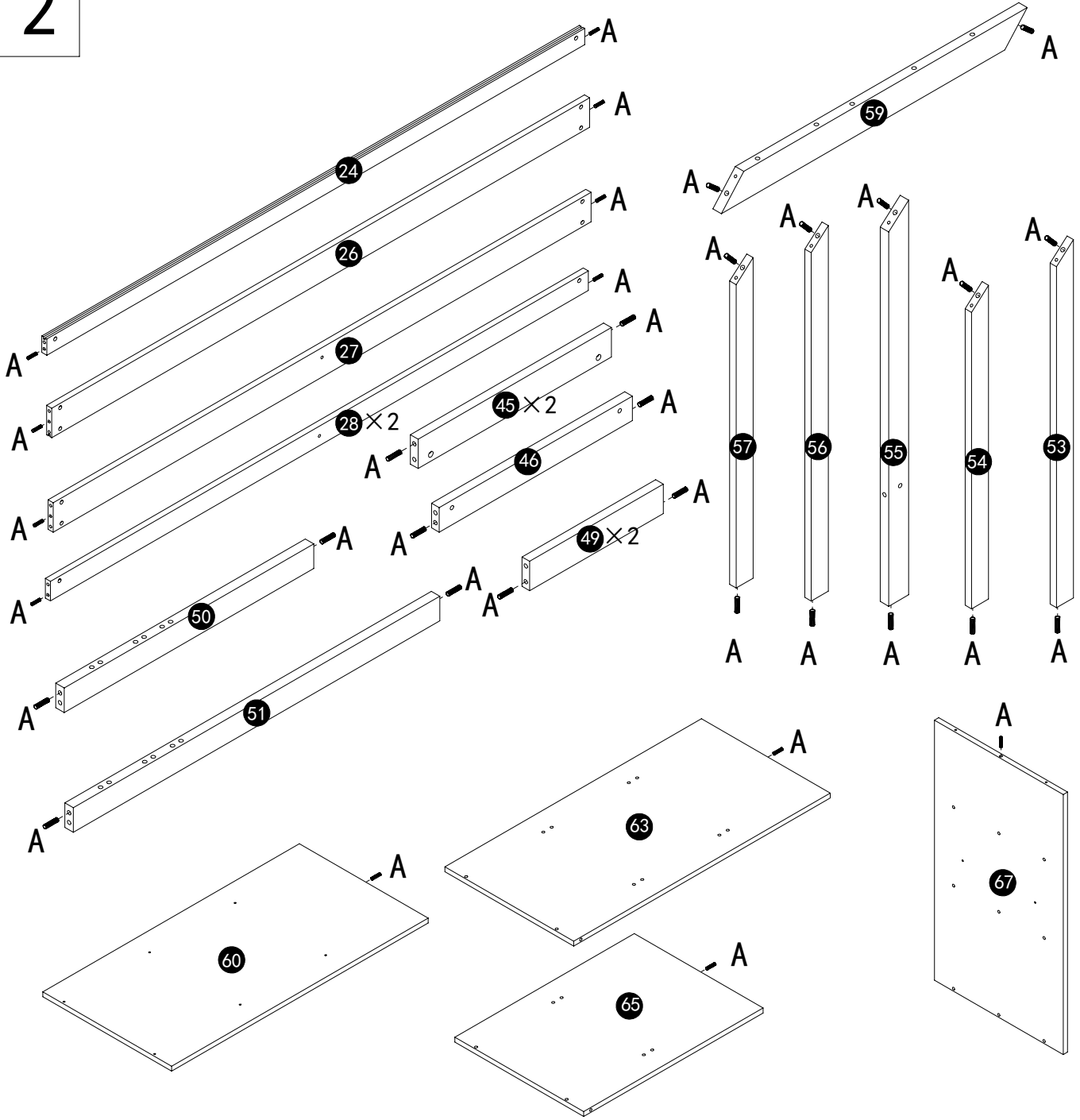

A × 40 pcs

3

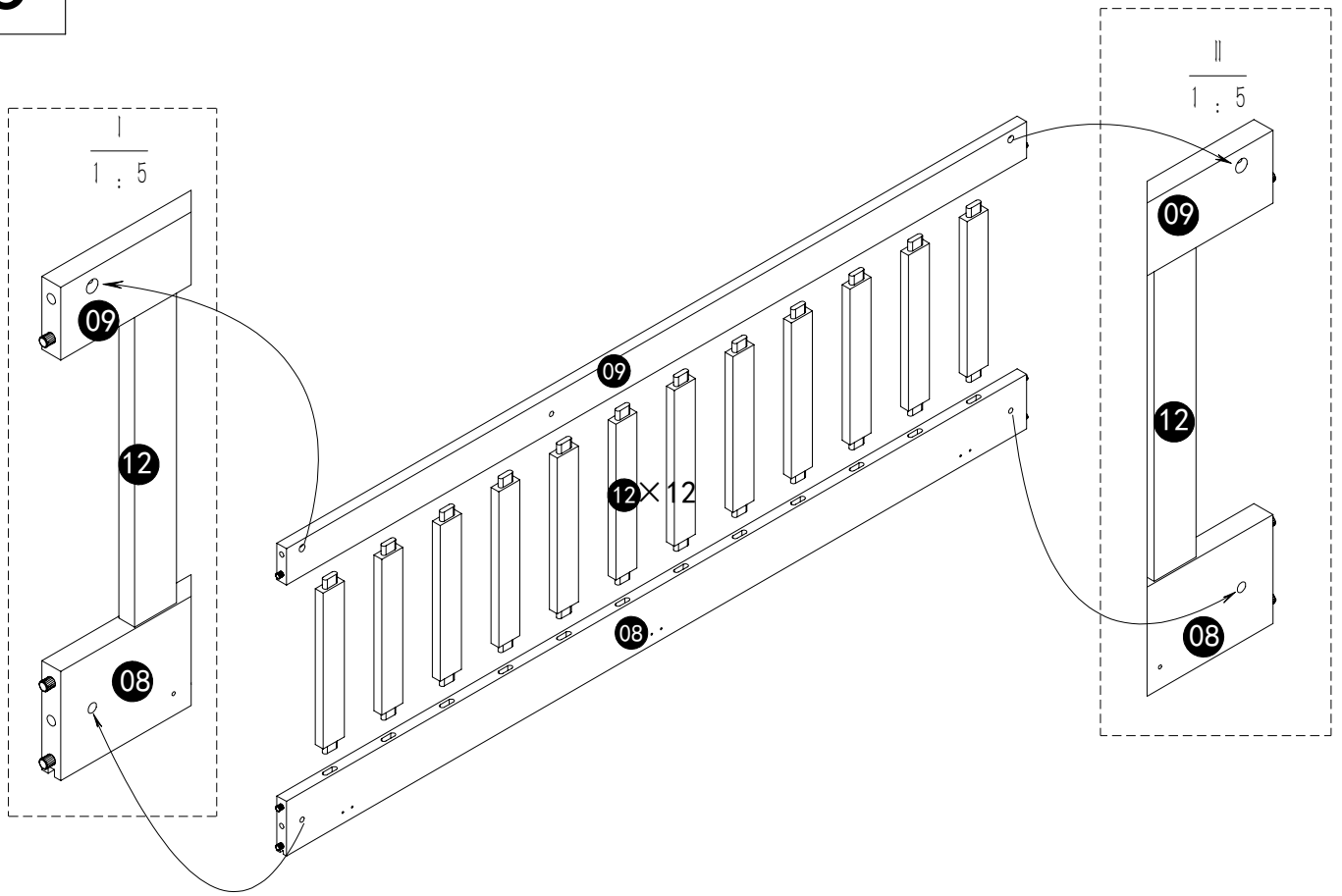

4

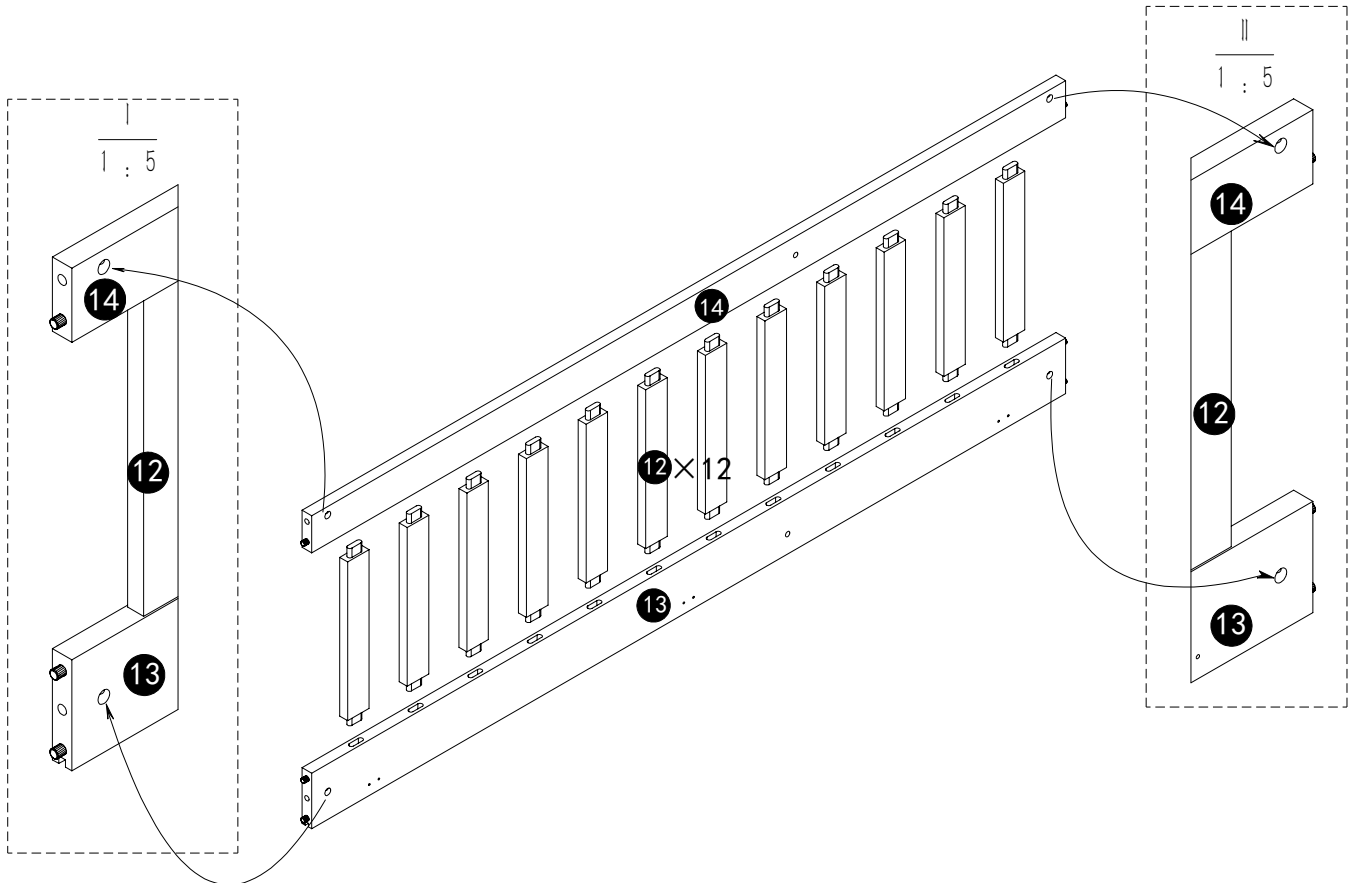

5

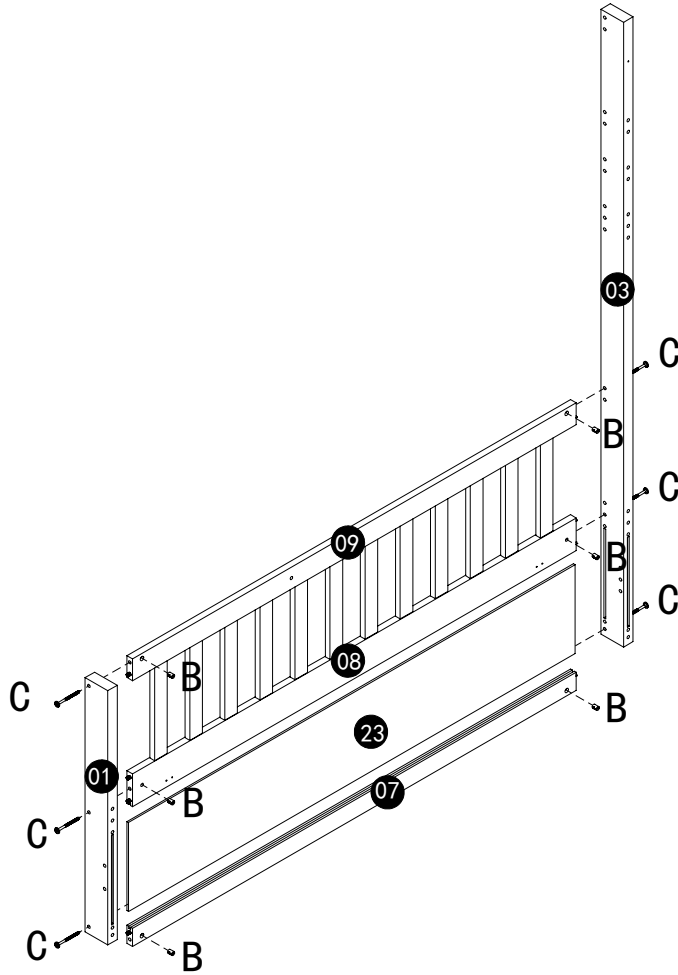
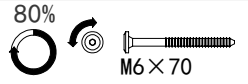

$\phi 10 \times 13$
$B \times 6\text{pcs}$
$M6 \times 70$
$C \times 6\text{pcs}$

6

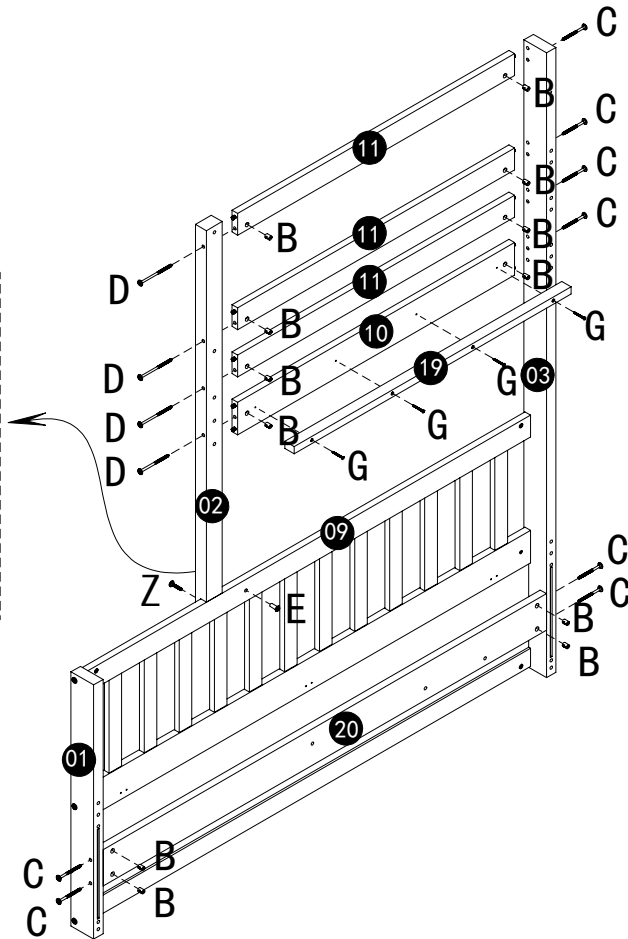
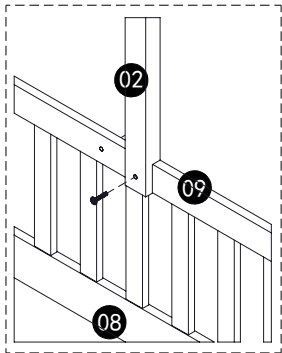
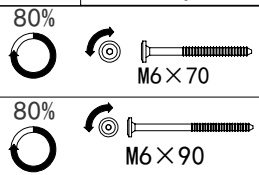

$\phi 10 \times 13$
$B \times 12\text{pcs}$
$M6 \times 70$
$C \times 8\text{pcs}$
$M6 \times 90$
$D \times 4\text{pcs}$
$\phi 6 \times 20$
$E \times 1\text{pcs}$
$M6 \times 25$
$Z \times 1\text{pcs}$
$\phi 4 \times 40$
$G \times 4\text{pcs}$

7

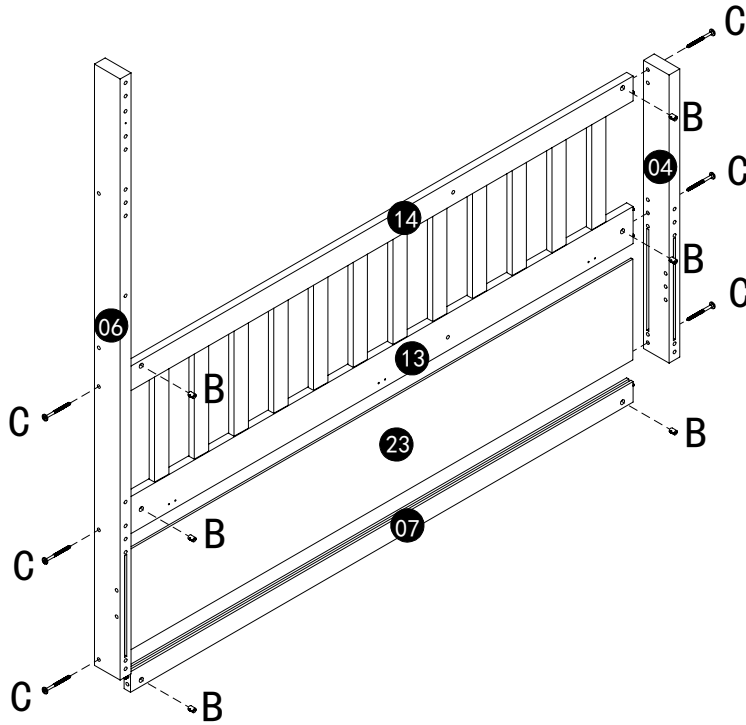
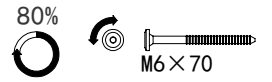

$\phi 10 \times 13$
<b>B × 6 pcs</b>
M6 × 70
<b>C × 6 pcs</b>

8

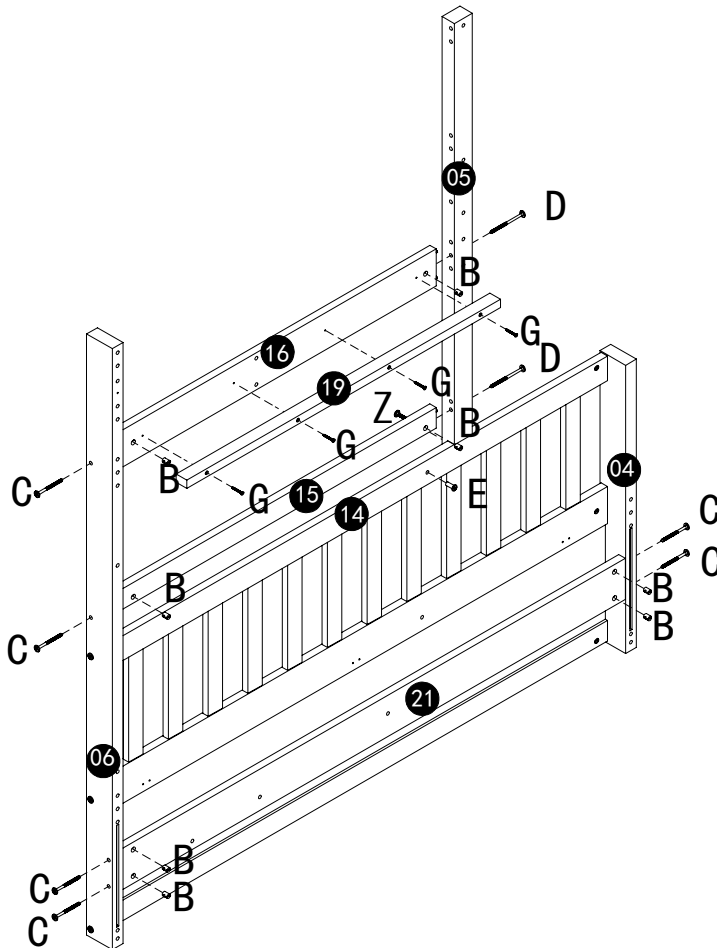
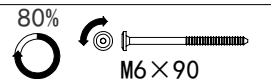

$\phi 10 \times 13$
<b>B × 8 pcs</b>
M6 × 70
<b>C × 6 pcs</b>
M6 × 90
<b>D × 2 pcs</b>
$\phi 6 \times 20$
<b>E × 1 pcs</b>
M6 × 25
<b>Z × 1 pcs</b>
$\phi 4 \times 40$
<b>G × 4 pcs</b>

9

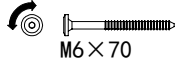

M6×70

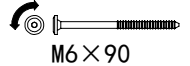

M6×90

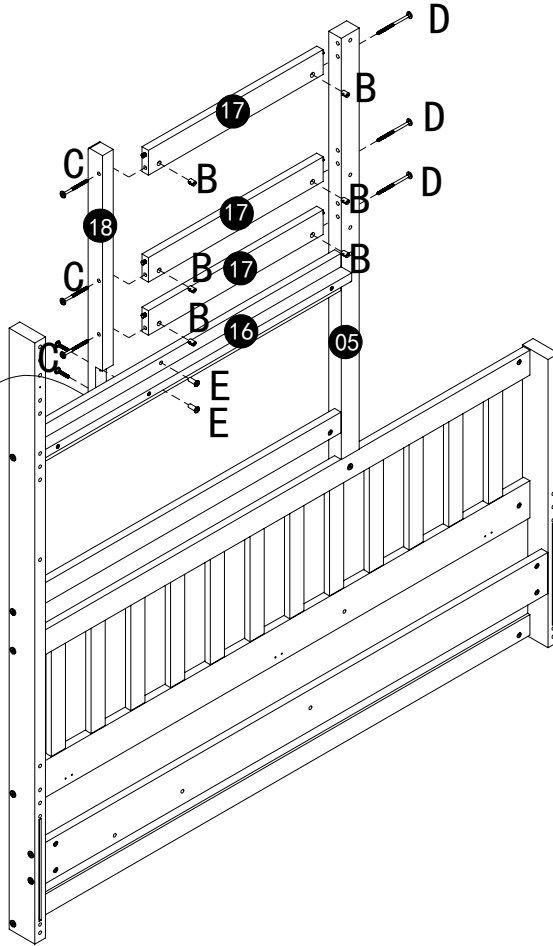
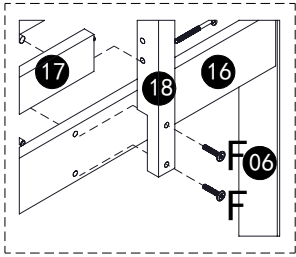

φ 10×13

B×6pcs

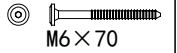

M6×70

C×3pcs

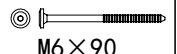

M6×90

D×3pcs

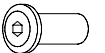

φ 6×20

E×2pcs

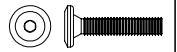

M6×30

F×2pcs

10

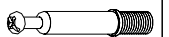
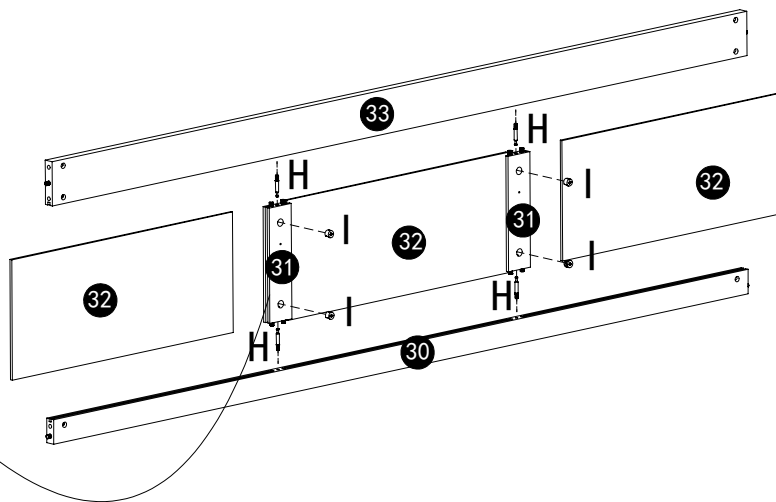
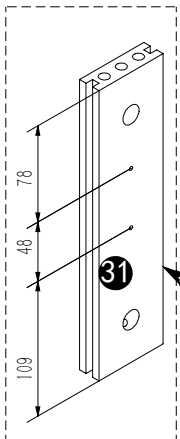

H×4pcs

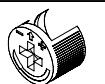



I×4pcs

# 11

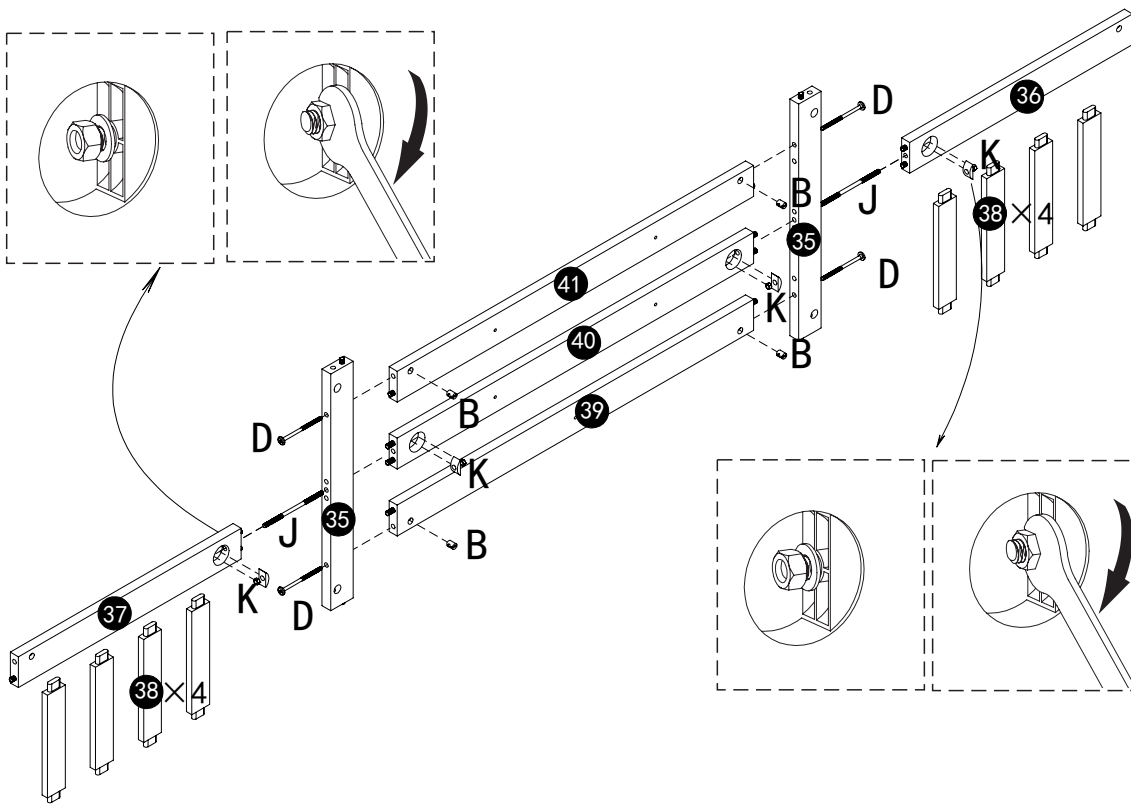
100%  M6×90

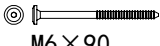
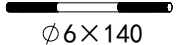



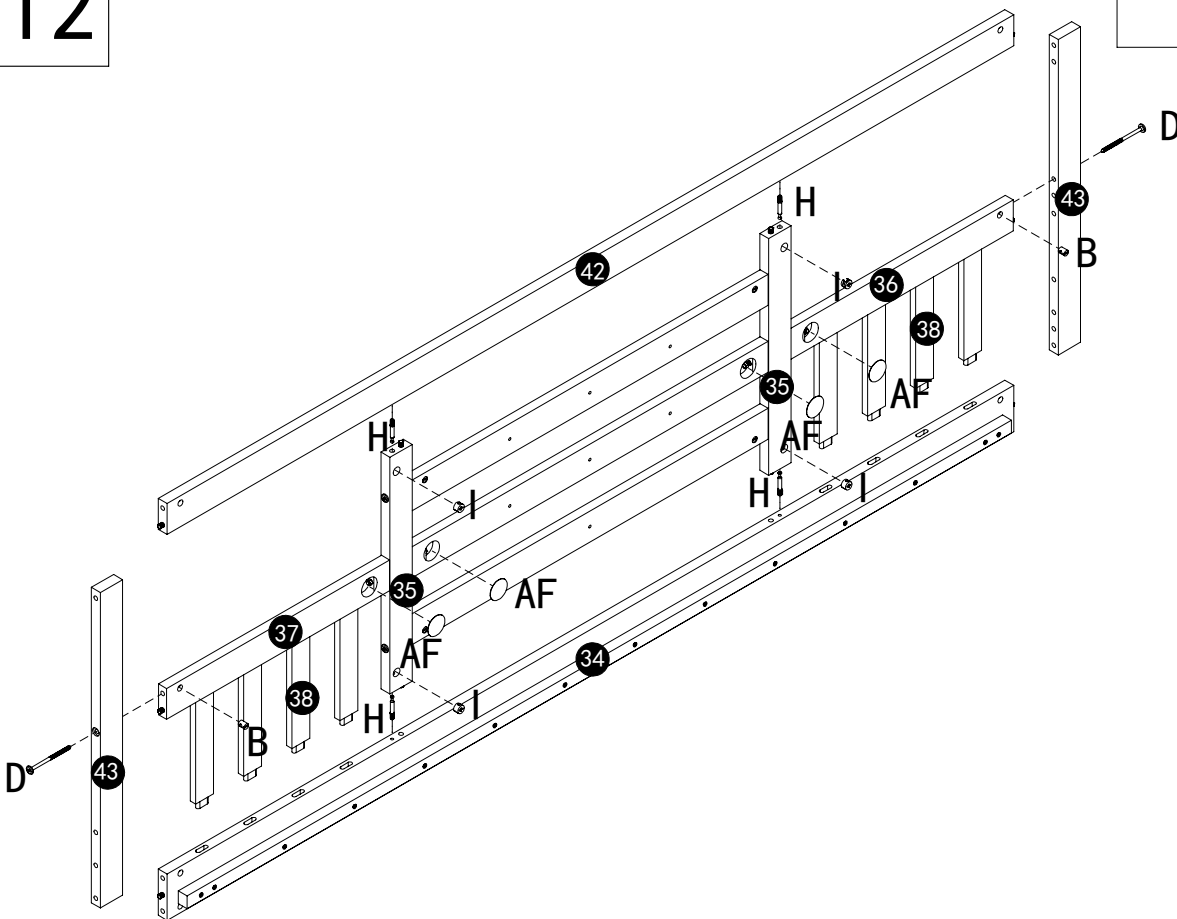

-   $\phi 10 \times 13$   
B × 4pcs
-  M6×90  
D × 4pcs
-   $\phi 6 \times 140$   
J × 2pcs
-  K × 4pcs
-  L × 2pcs

# 12

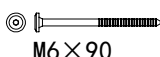
100%  M6×90



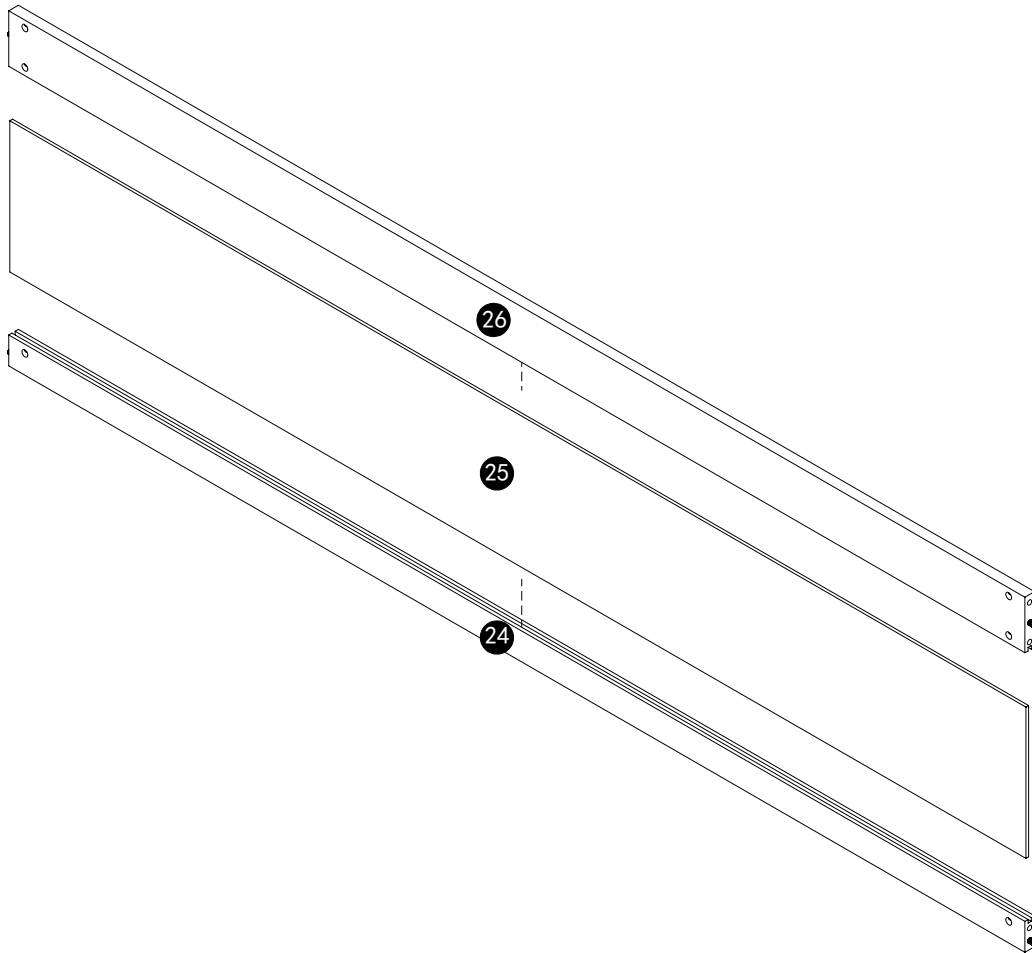

-   $\phi 10 \times 13$   
B × 2pcs
-  M6×90  
D × 2pcs
-  H × 4pcs
-  I × 4pcs
-  AF × 4pcs

13



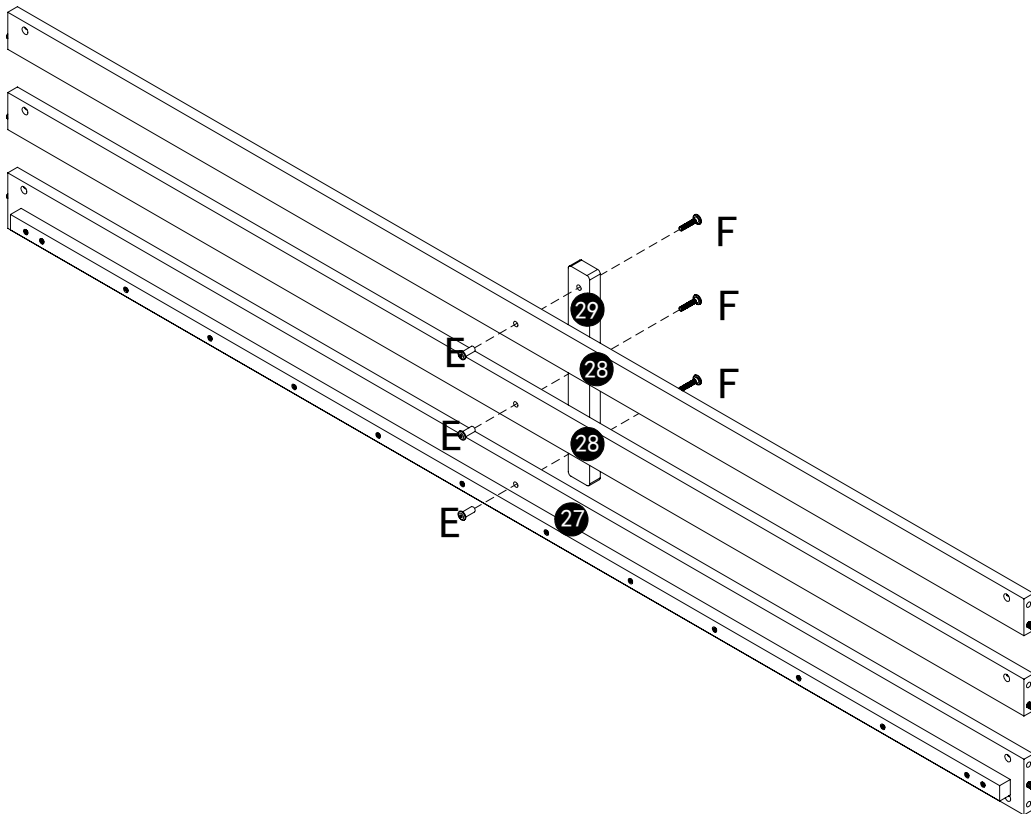





14

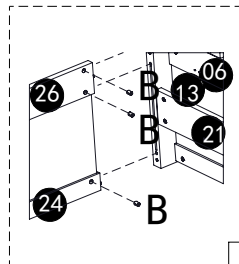
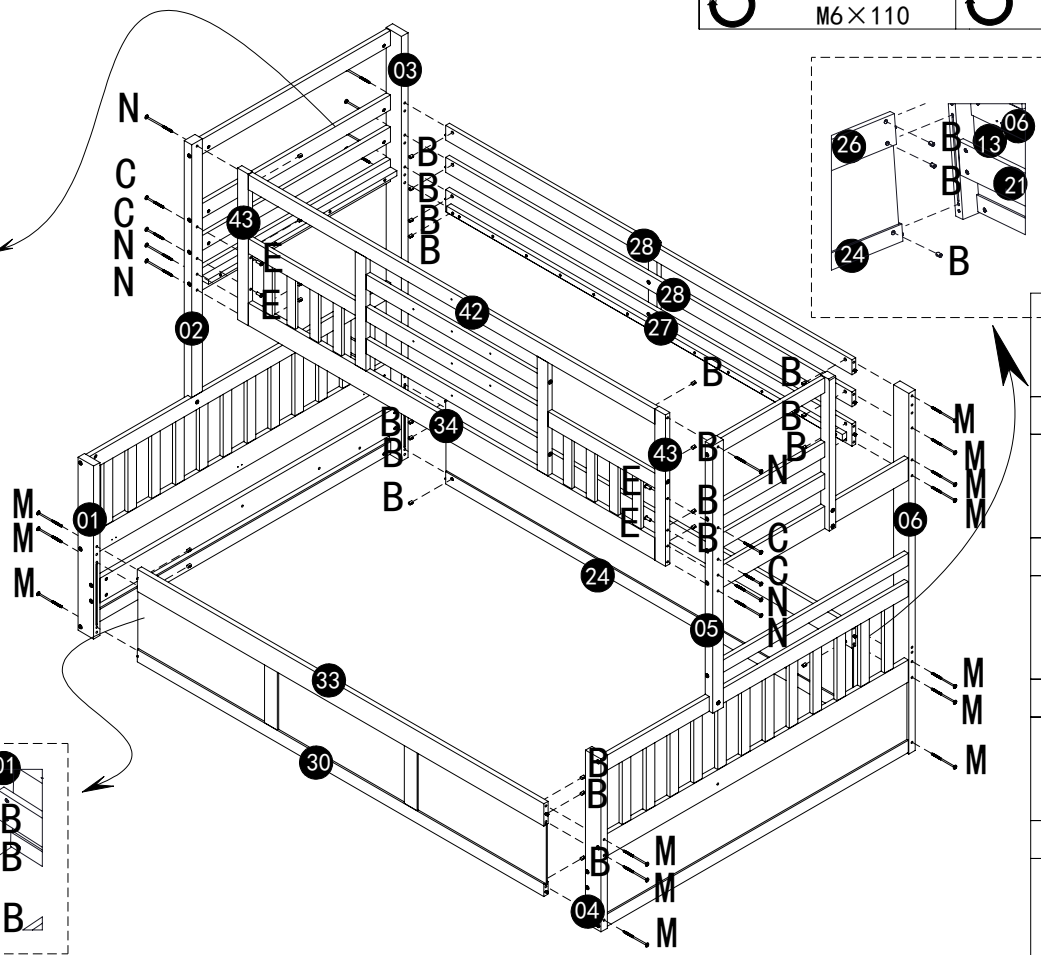
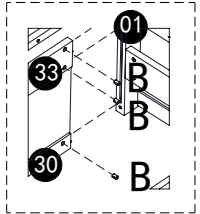
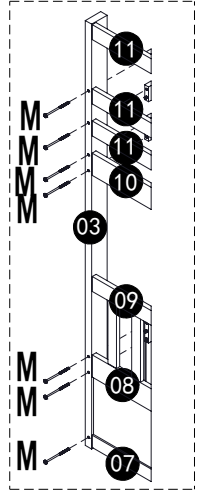
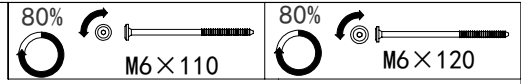



$\phi 6 \times 20$
<b>E X 3pcs</b>

M6 X 30
<b>F X 3pcs</b>

# 15

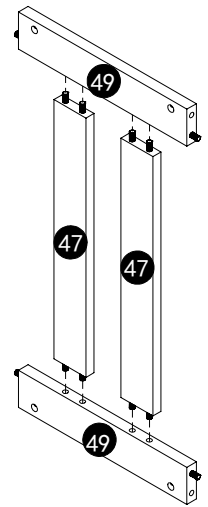
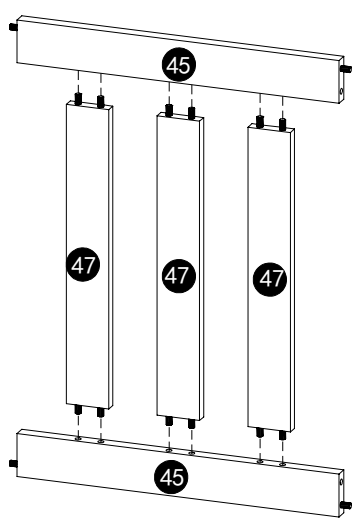

-   $\phi 10 \times 13$
- B**  $\times$  26pcs
-   $M6 \times 70$
- C**  $\times$  4pcs
-   $\phi 6 \times 20$
- E**  $\times$  4pcs
-   $M6 \times 110$
- M**  $\times$  20pcs
-   $M6 \times 120$
- N**  $\times$  6pcs

# 16



# 17

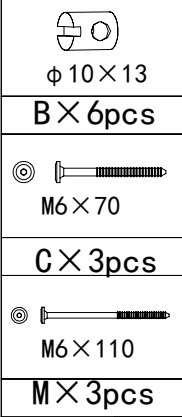
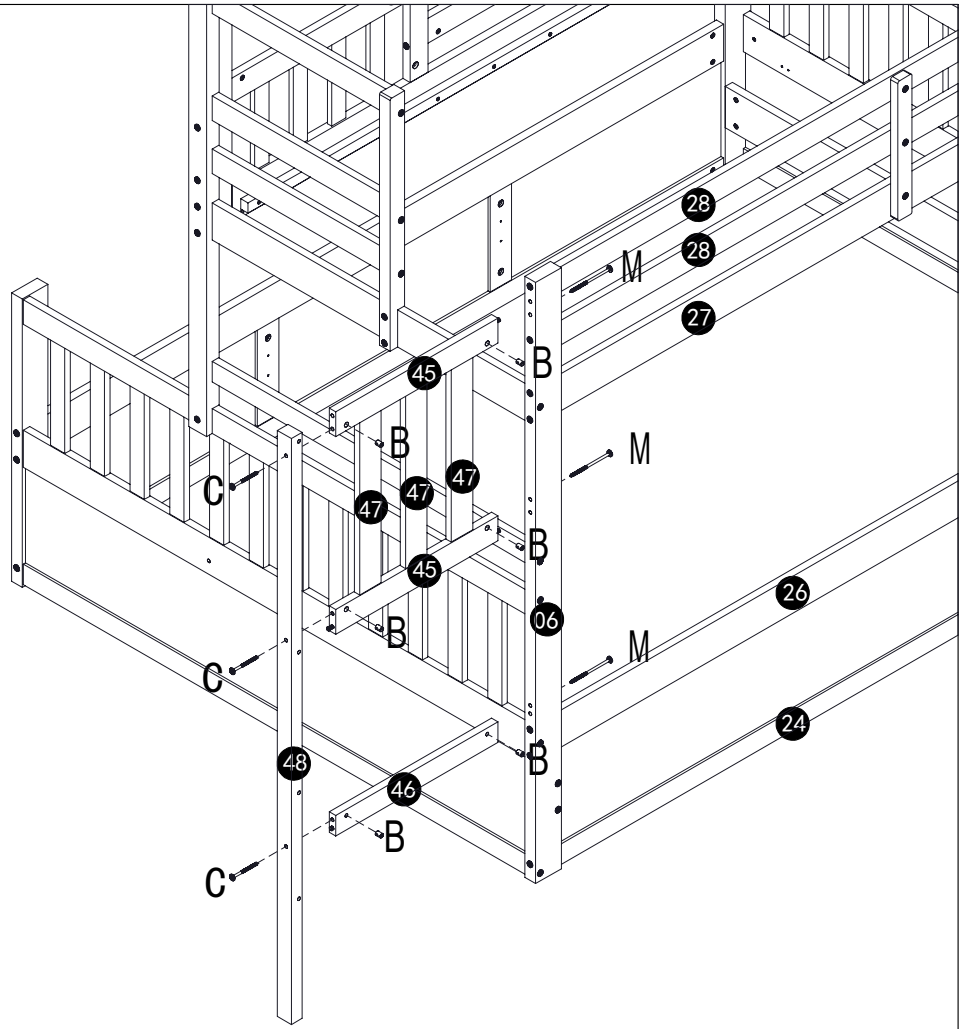
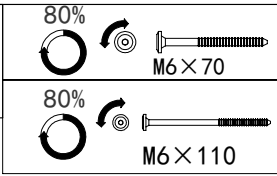

# 18

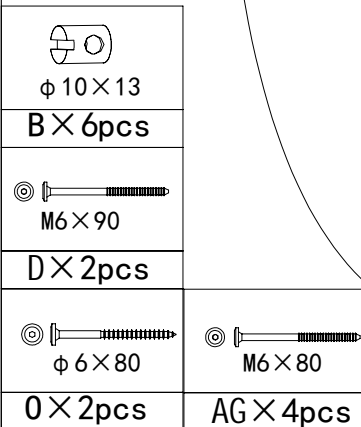
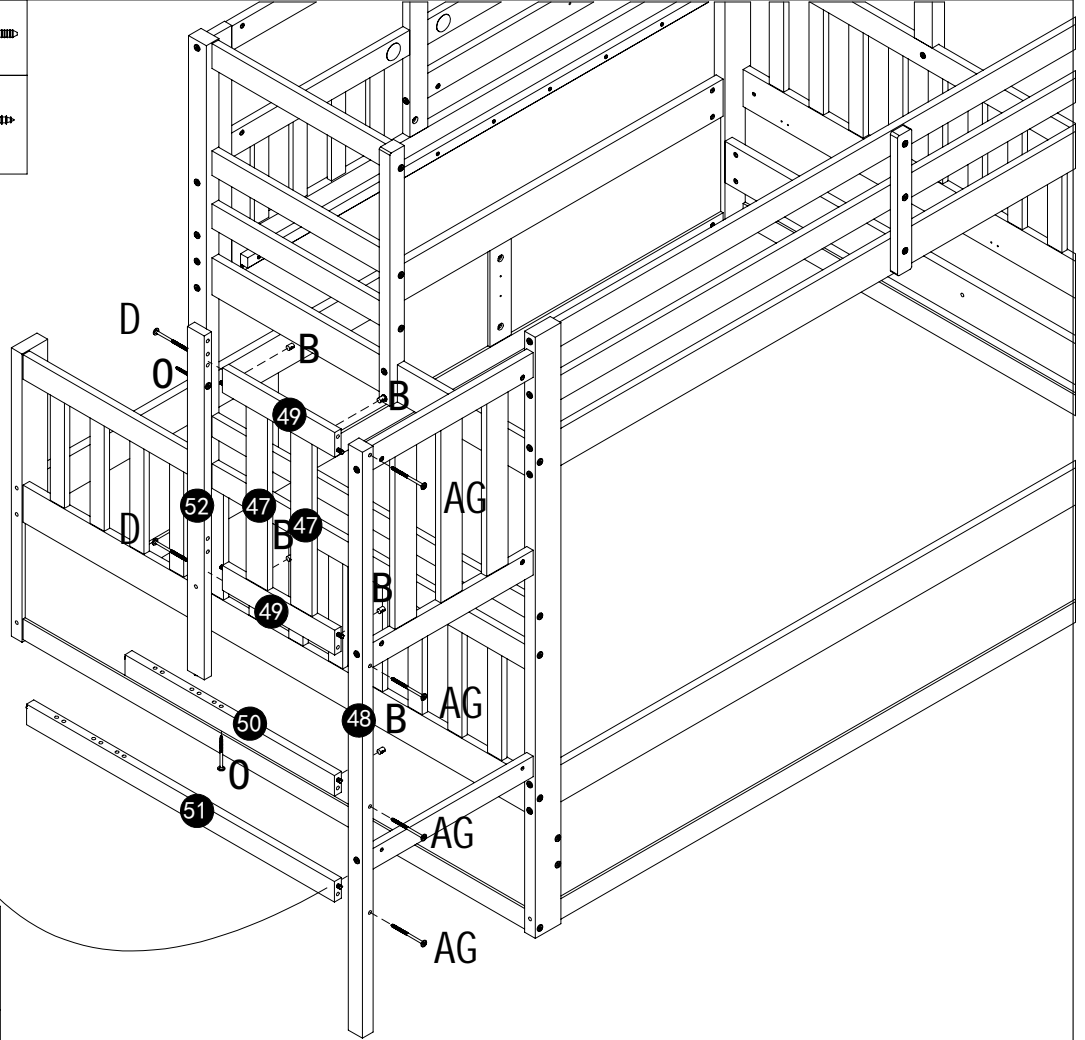
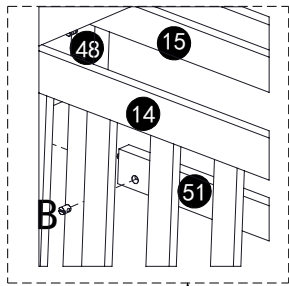
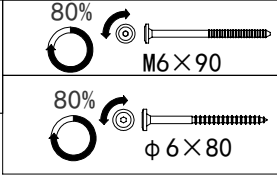

19

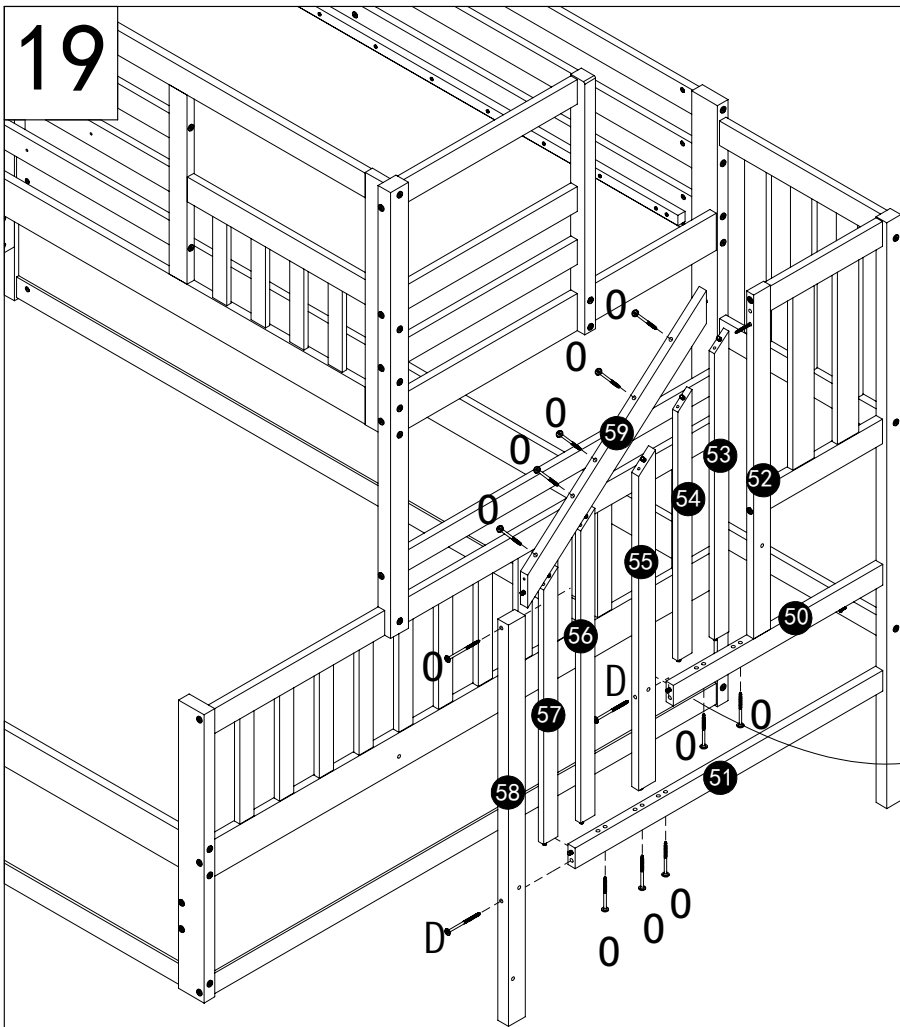

- 80% M6×90
- 80% φ 6×80

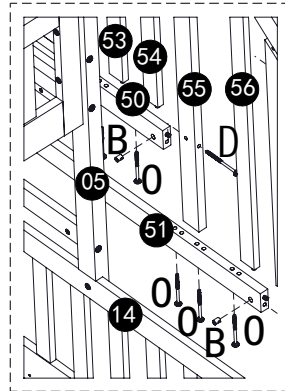

- φ 10×13
- B×2pcs
- M6×90
- D×2pcs
- φ 6×80
- 0×11pcs

20

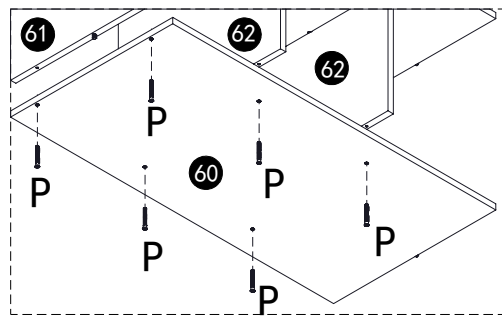
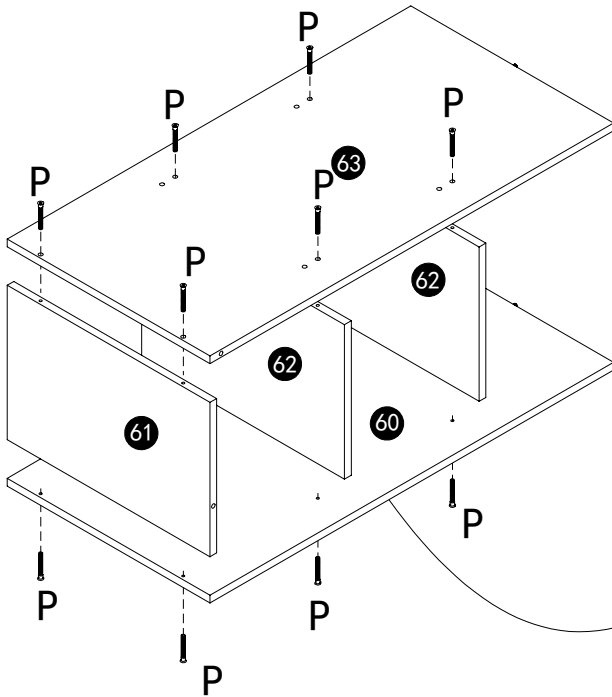

- φ 7×50
- P×12pcs

21

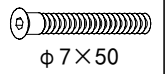
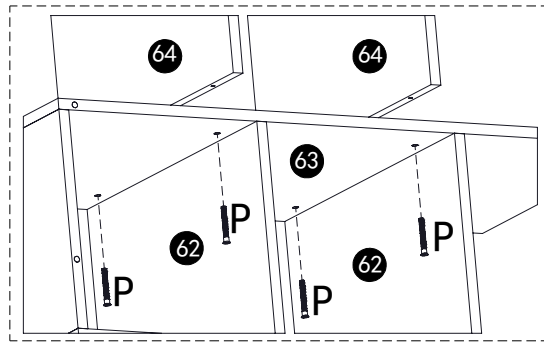
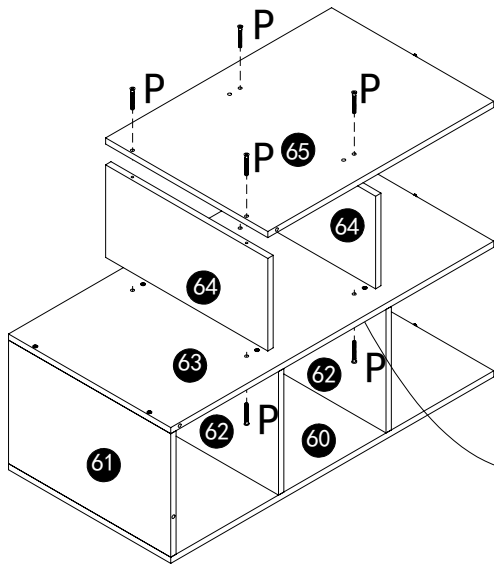

P × 8 pcs

22

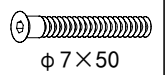
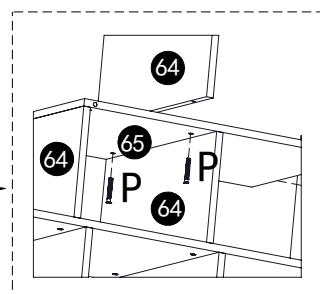
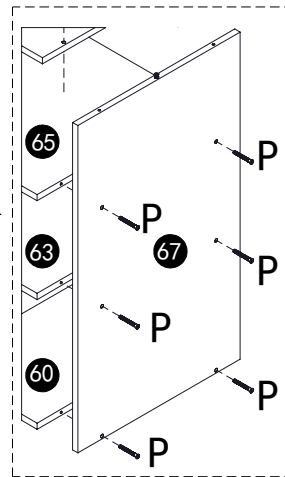
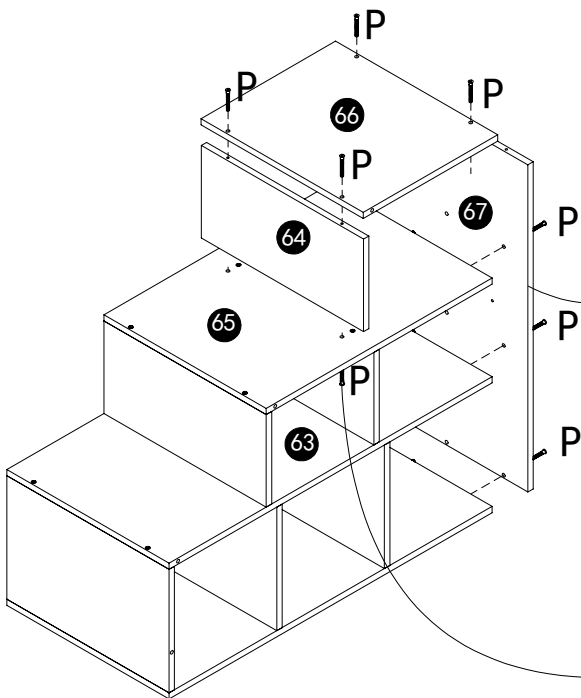

P × 12 pcs

23

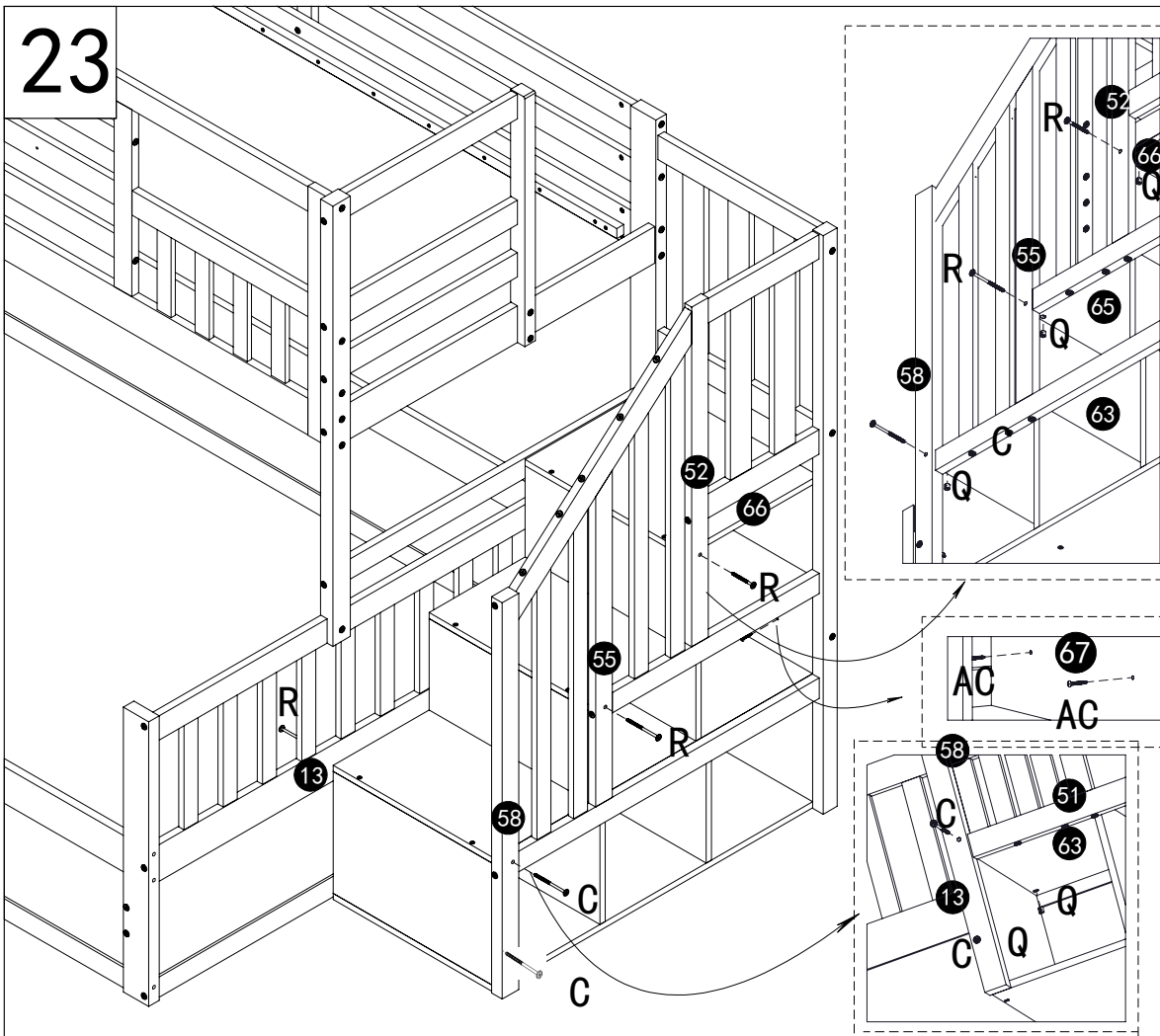

- 100% M6 × 70
- 100% M6 × 90
- 100% M6 × 110
- 100% M6 × 120
- 100% M6 × 60
- 100% φ 6 × 80

- M6 × 70
- C × 2pcs
- φ 10 × 10
- Q × 5pcs
- M6 × 60
- R × 3pcs
- φ 4 × 30
- AC × 2pcs

24

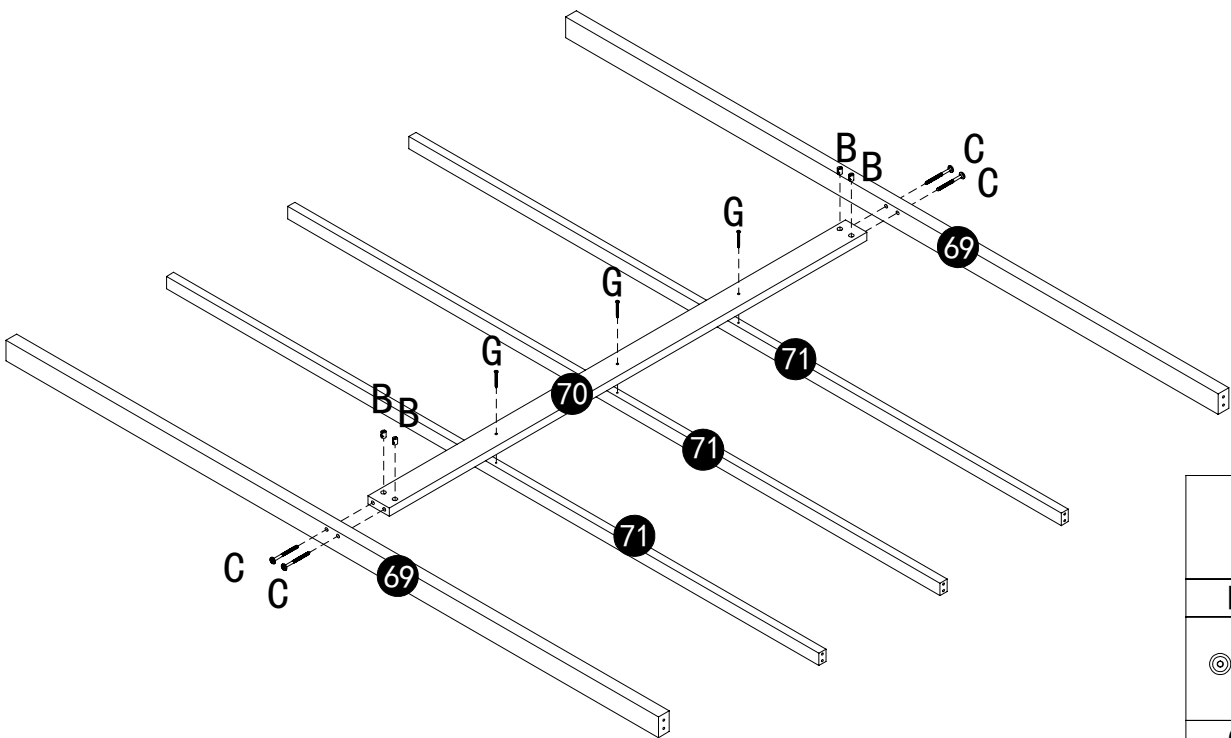

- 100% M6 × 70

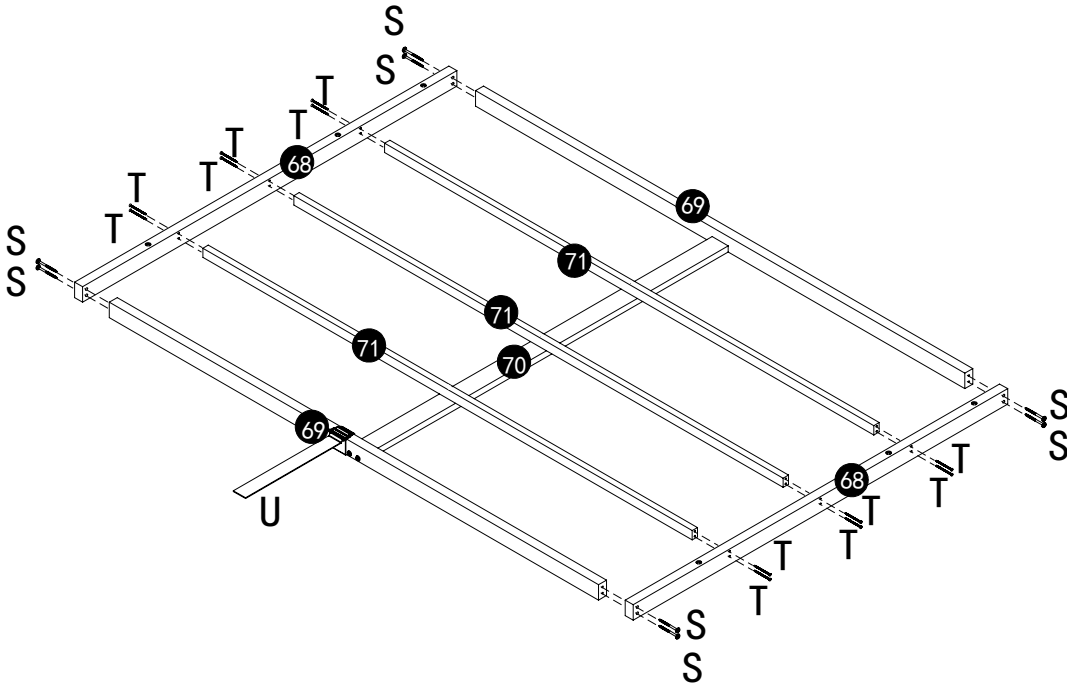

- φ 10 × 13
- B × 4pcs
- M6 × 70
- C × 4pcs
- φ 4 × 40
- G × 3pcs

25

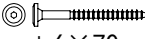

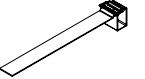
-   $\phi 6 \times 70$
- S  $\times$  8 pcs
-   $\phi 4 \times 50$
- T  $\times$  12 pcs
- 
- U  $\times$  1 pcs

26

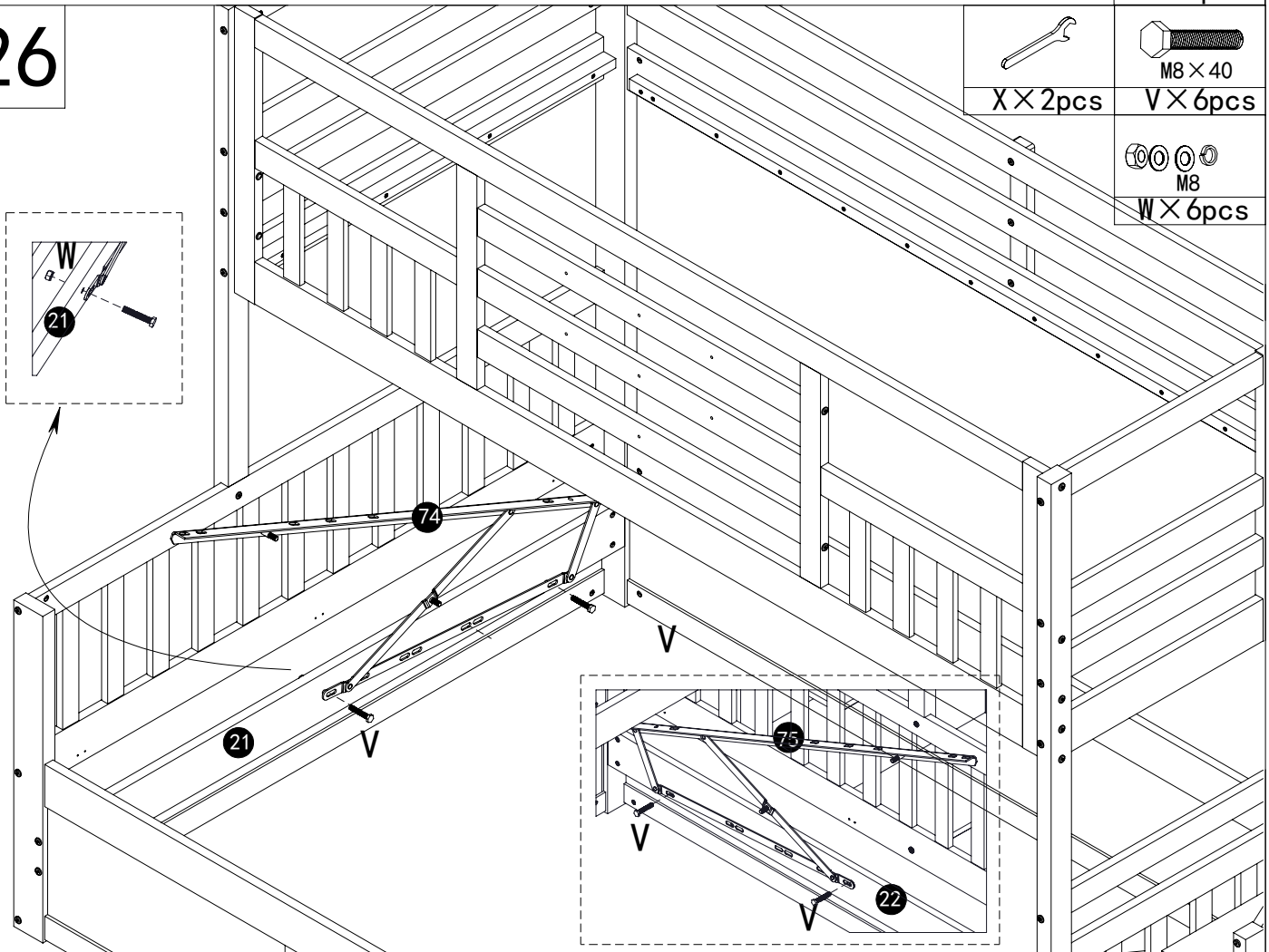

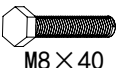
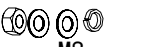
- 
- X  $\times$  2 pcs
-  M8  $\times$  40
- V  $\times$  6 pcs
-  M8
- W  $\times$  6 pcs

# 27

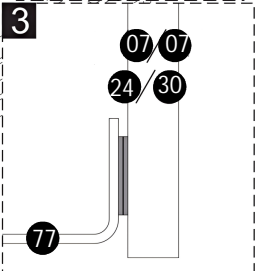
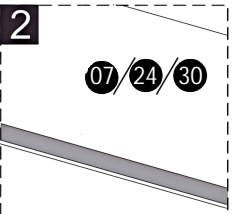
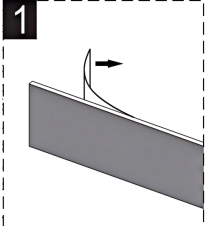

AH × 1 pcs

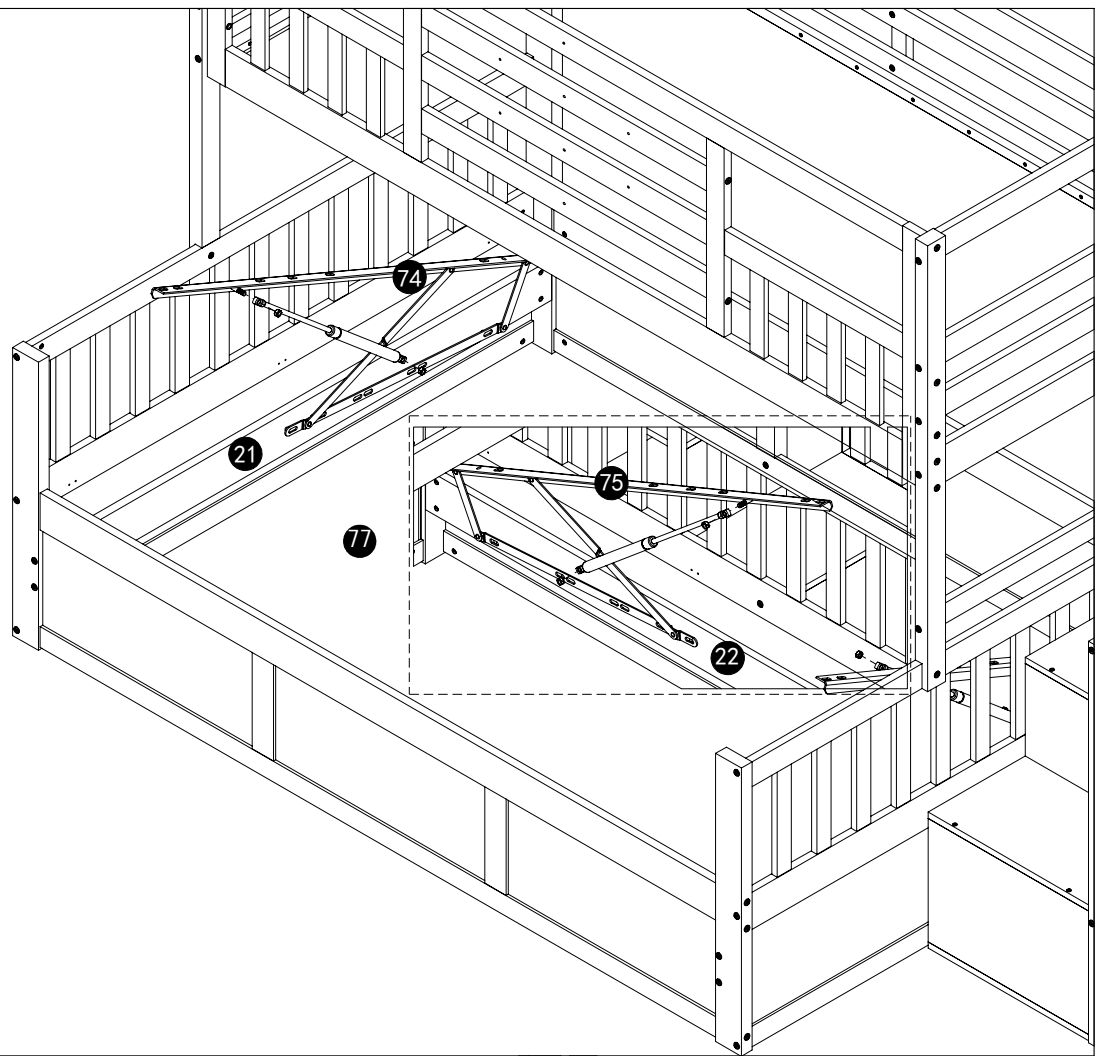

# 28

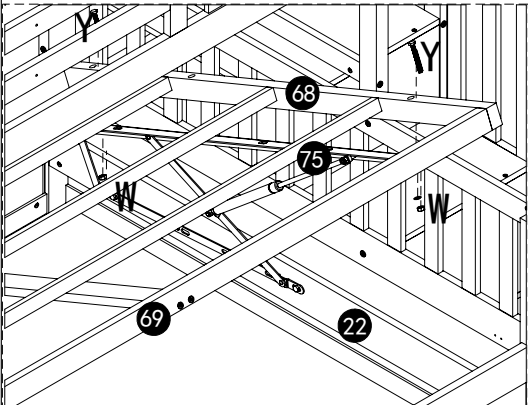

X × 2 pcs

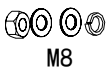

M8

W × 6 pcs

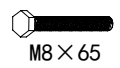

M8 × 65

Y × 6 pcs

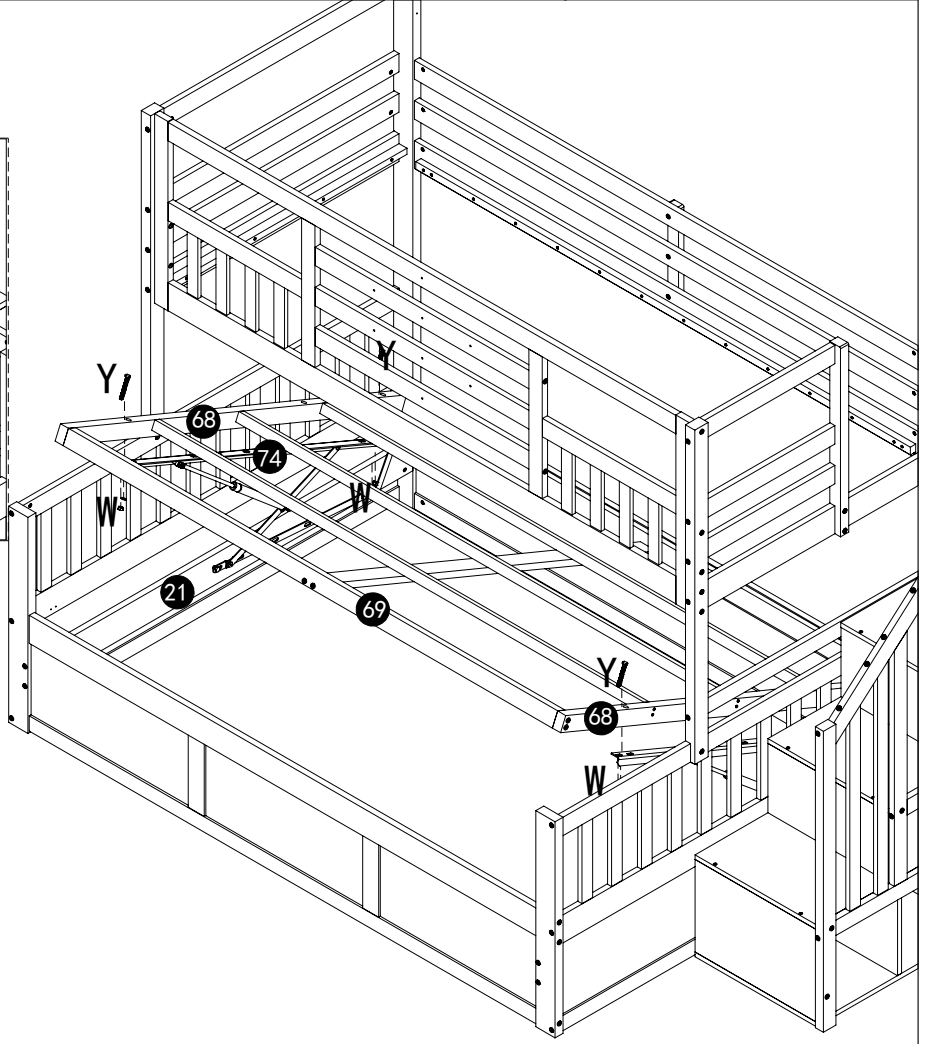

29

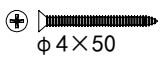
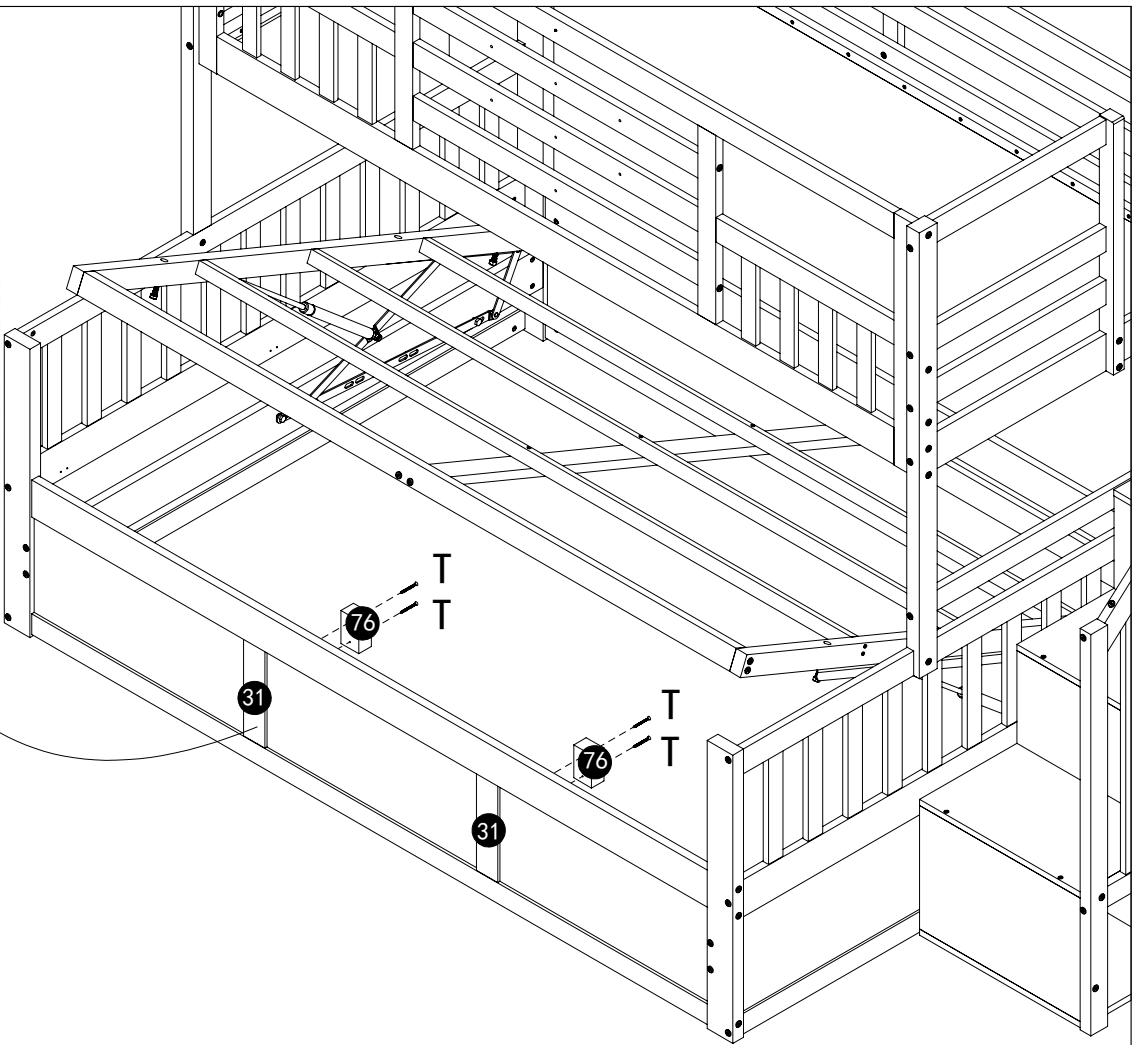
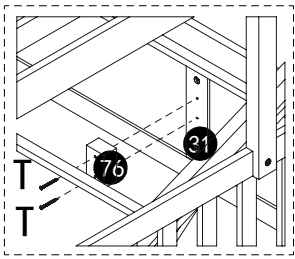

φ 4 × 50

T × 4 pcs

30

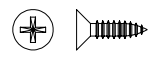
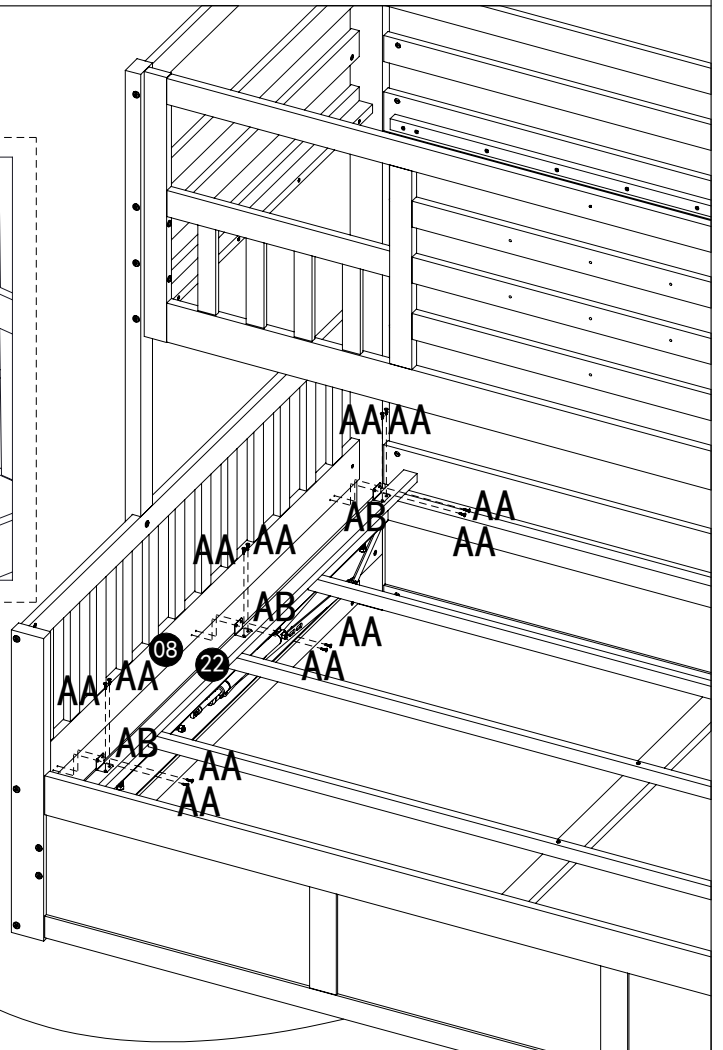
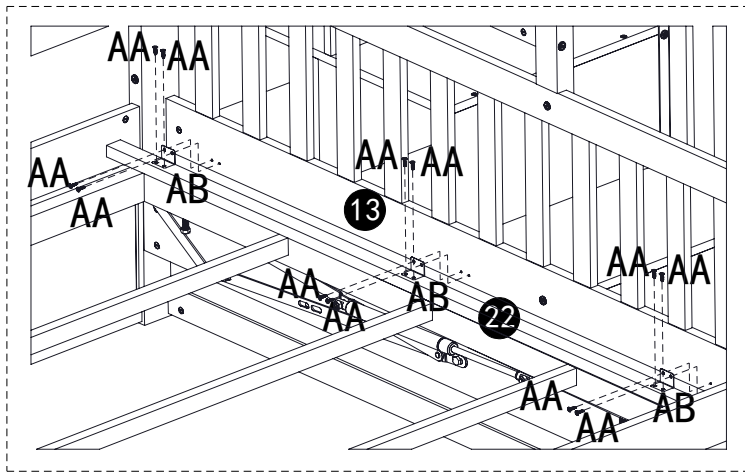

φ 3.5 × 14

AA × 24 pcs

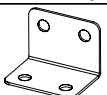

AB × 6 pcs

31

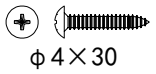
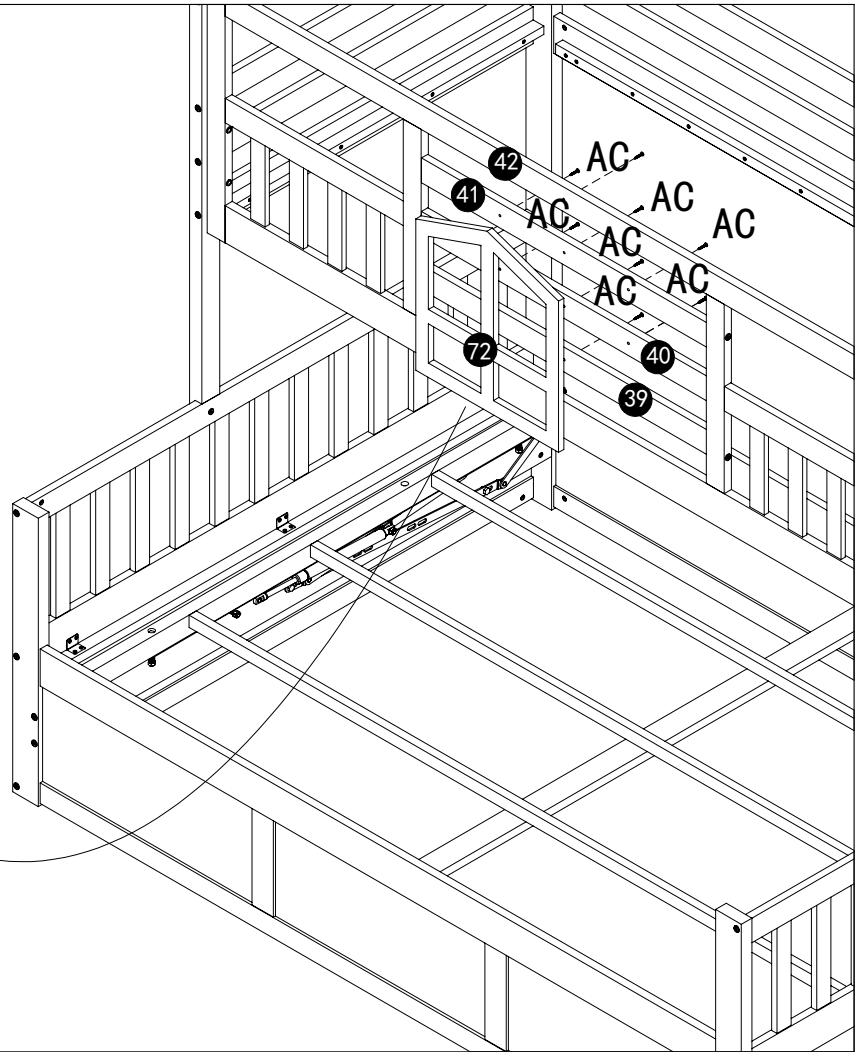
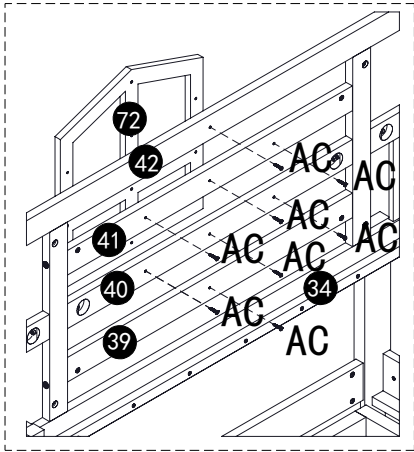

AC  $\times$  8pcs

32

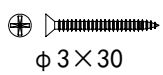
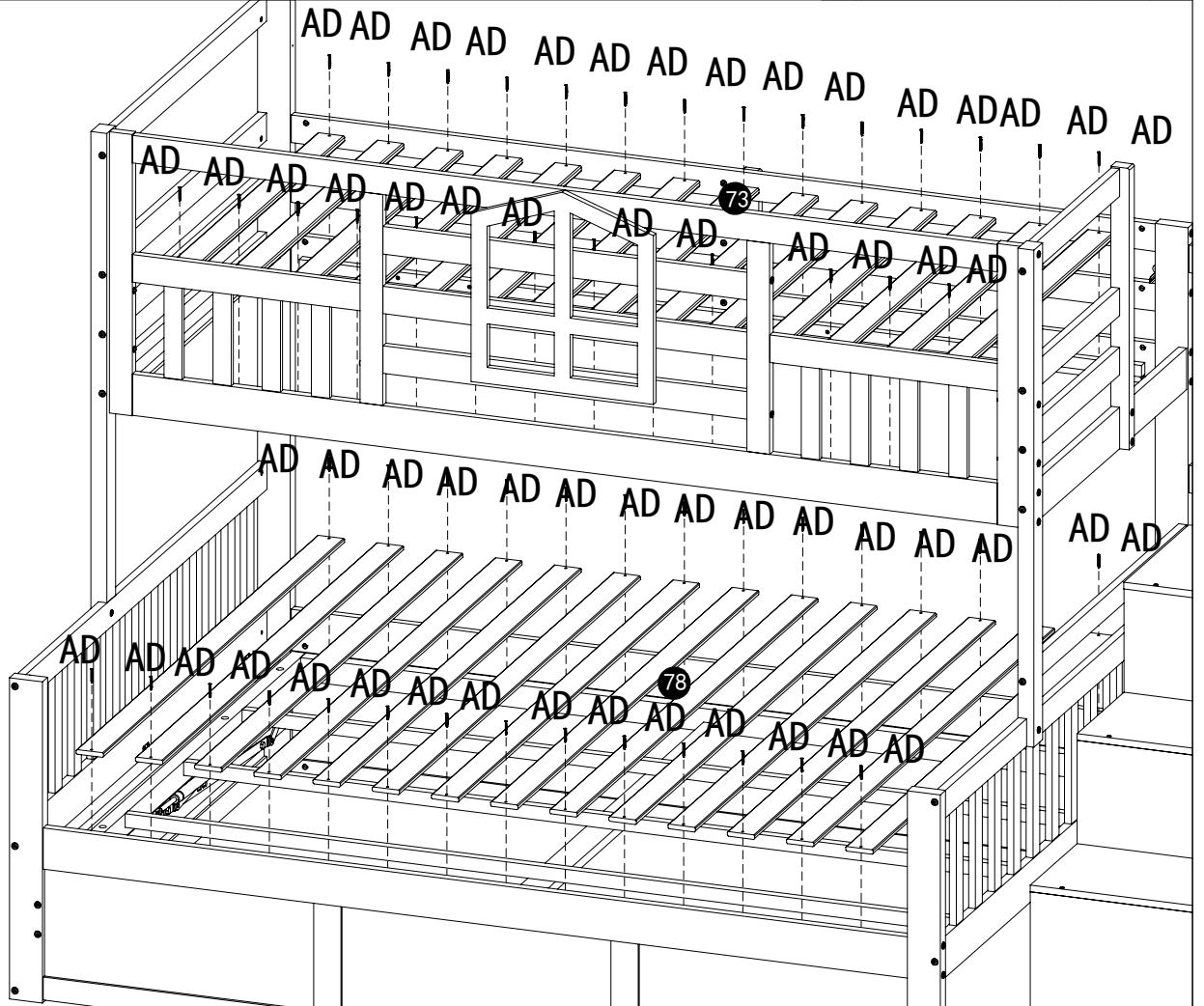

AD  $\times$  56pcs

