

# ASSEMBLY INSTRUCTION

 This instruction booklet contains important safety information, please read and keep for future reference.

This sofa collection work as modular sofa function,it can be a single sofa ,2 seater sofas,3 seater sofas,4 seater sofas,L shape sofas,ottoman,sofa sets with buying different sections of the sofas and combine them together. You can decide to buy more components according to your living room size.

To ensure safe and satisfactory use of this product,please carefully read the below instructions beforehand.



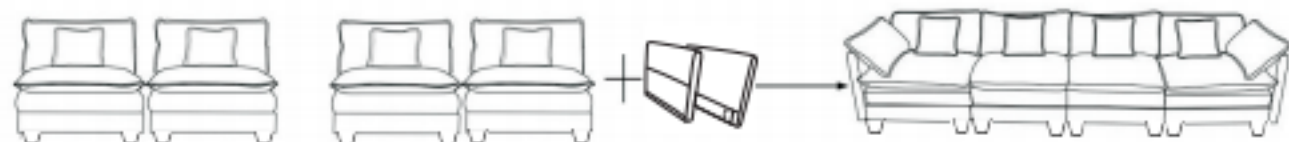
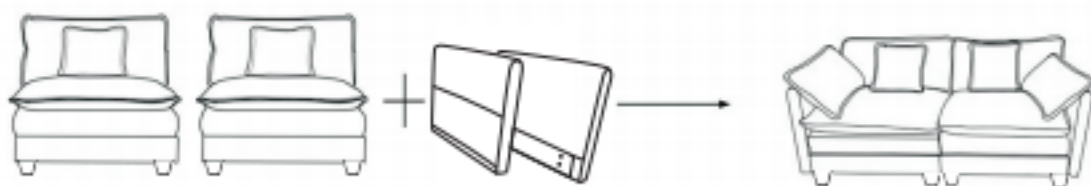
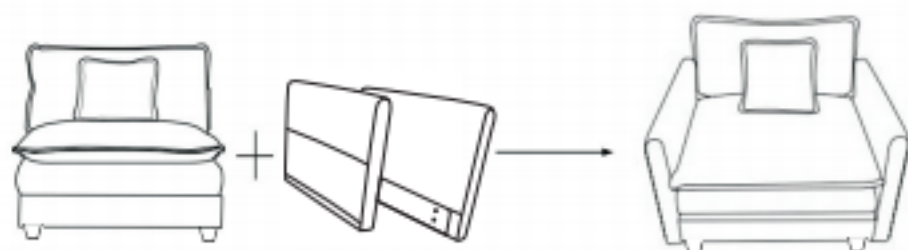

- 1.This sofa ships in several boxes,we recommend unpacking and starting assembly when several boxes are received.
- 2.Our cushions are vacuum packed for convenient shipping. Please allow 2-3 days for them to fully expand to their original shape and for any wrinkles to disappear.
- 3.In the event that a part is damaged or missing,no need to return the product,we will gladly help and ship your replacement parts free of charge.

**Below are some guidelines for you how you can do mix and match.**







- 
-  • Read instructions, cover to cover
  -  • Have 2 adults on hand for assembly
  -  • Do not assemble on flooring or carpet
  -  • Assemble on a clean non-marring surface (packing foam)
  -  • Save all packaging until finished

**IF YOU BUY A SINGLE SOFA**  
**please follow below assembly instruction**

**Parts included**

**Parts List (BOX 1)**

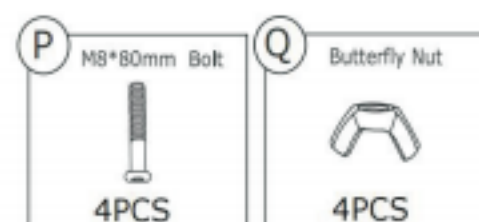
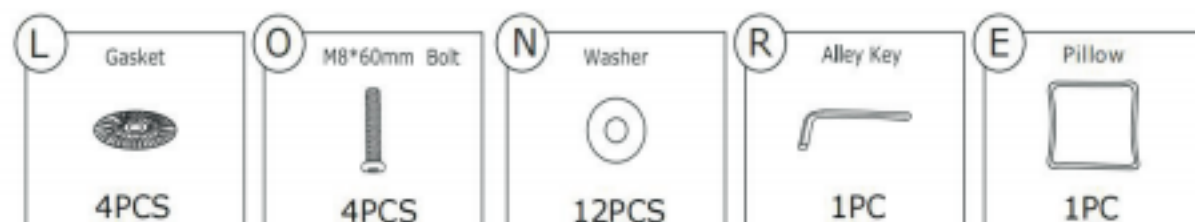
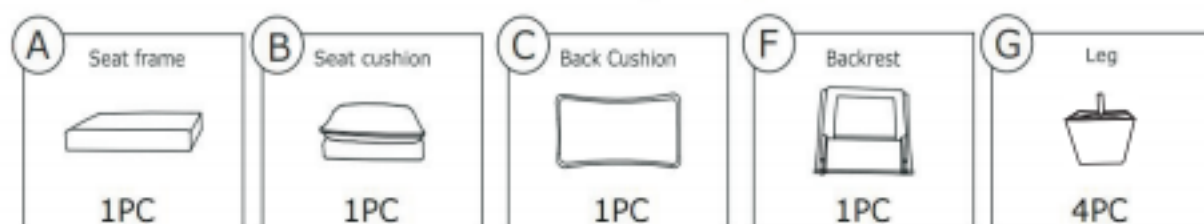

**Parts List (BOX 2)**

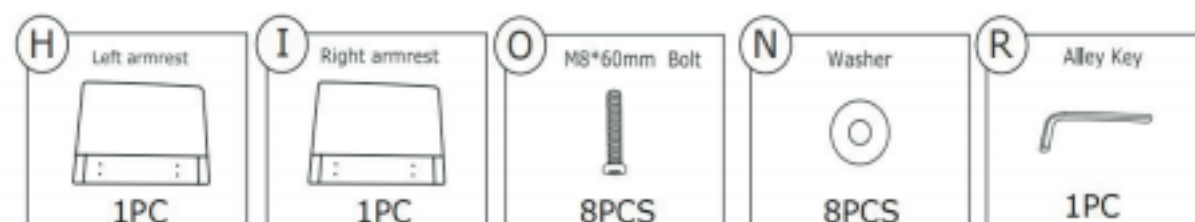

Note: Please retain all boxes until you are certain that your product isn't damaged and that you do not wish to return it. Disposal of boxes may prevent our ability to resolve your request.

## ASSEMBLY STEPS

STEP 1: Assemble the Left armrest (H) and the Right armrest (I) to the Seat frame (A) with Washers (N) and Bolts (O).

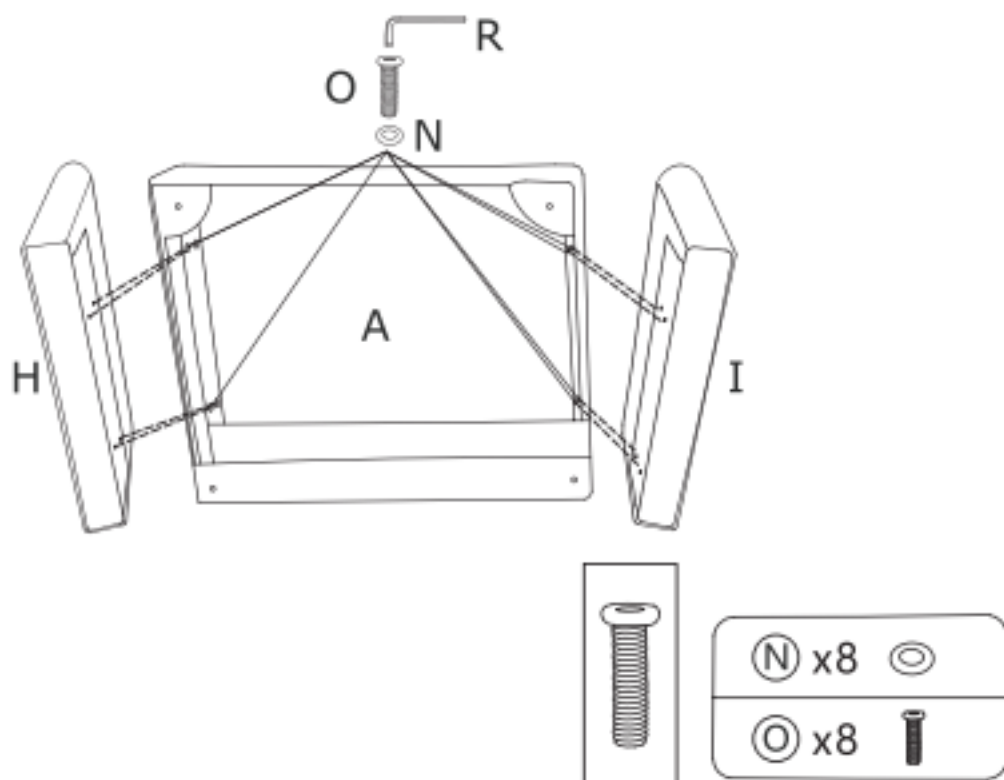

STEP 2: Assemble the Legs (G) on the sofa with Gaskets (L).

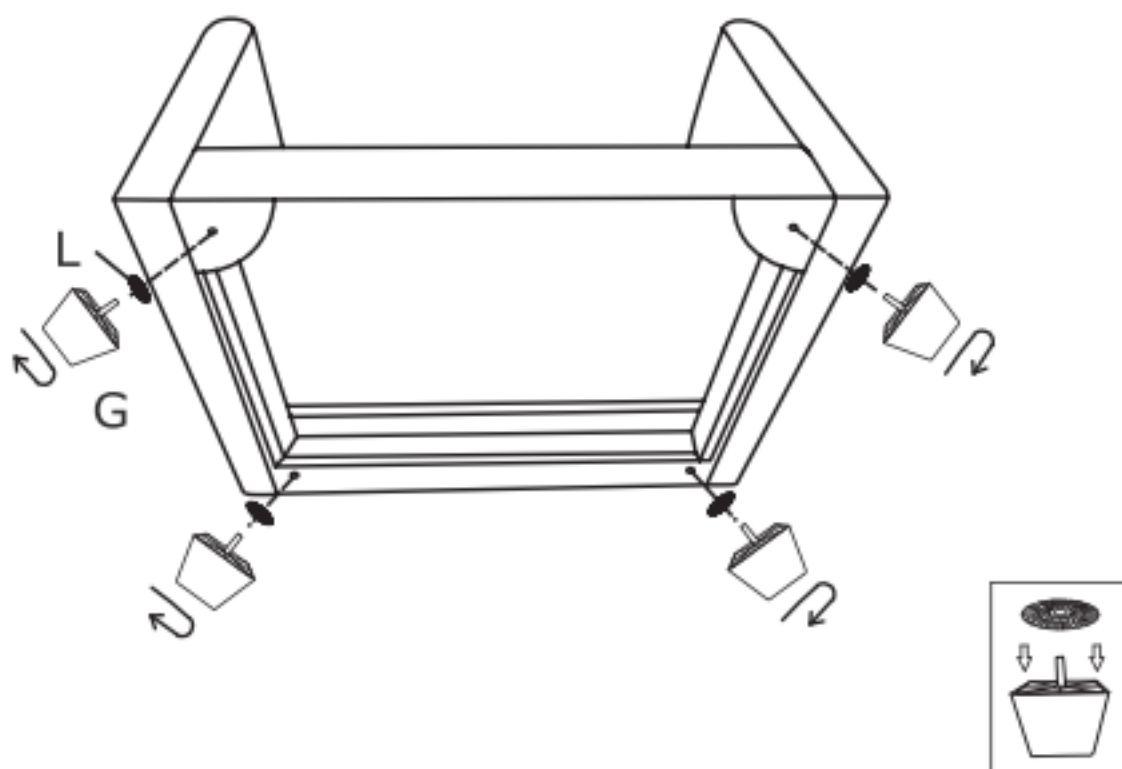

STEP 3: Insert the Backrest (F) into the designated holes, using Washers (N) and Bolts (O) to 70% tightness, and then tighten the all Bolts on the seat.

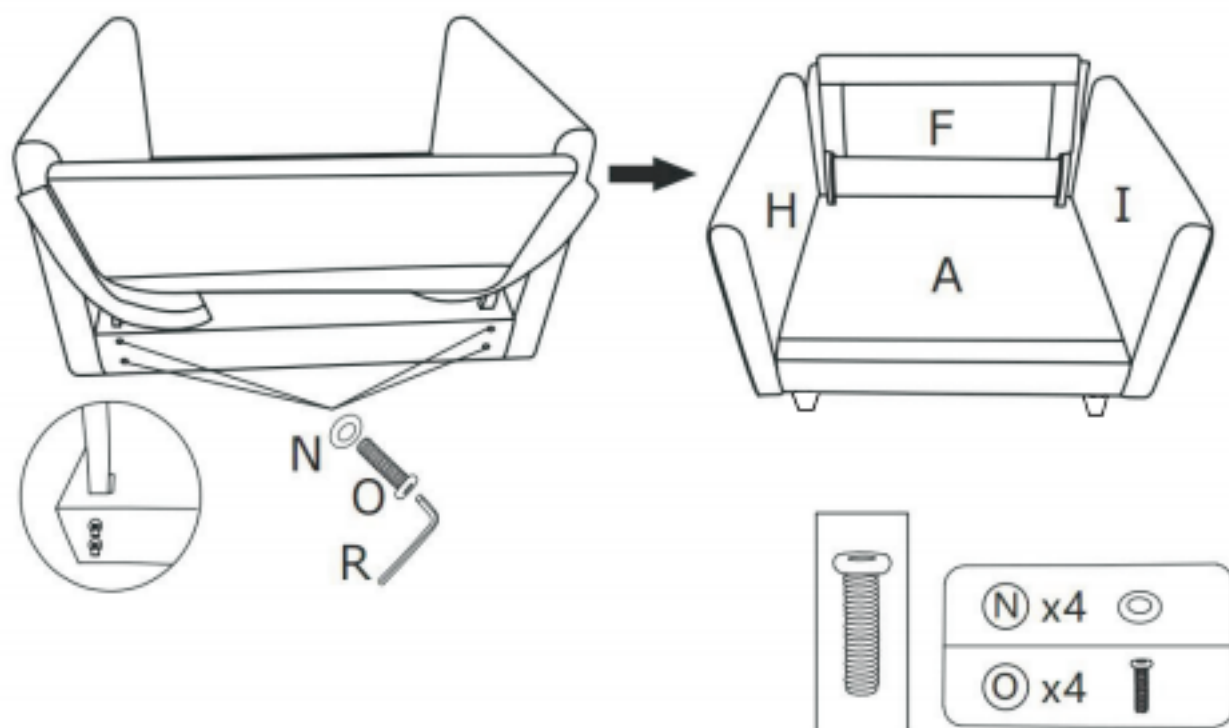

STEP 4: The cushion is packaged by vacuum compression. After cutting the package, it rebounds quickly within 4 hours. If the fabric has wrinkles, it will basically disappear after standing for 72 hours.

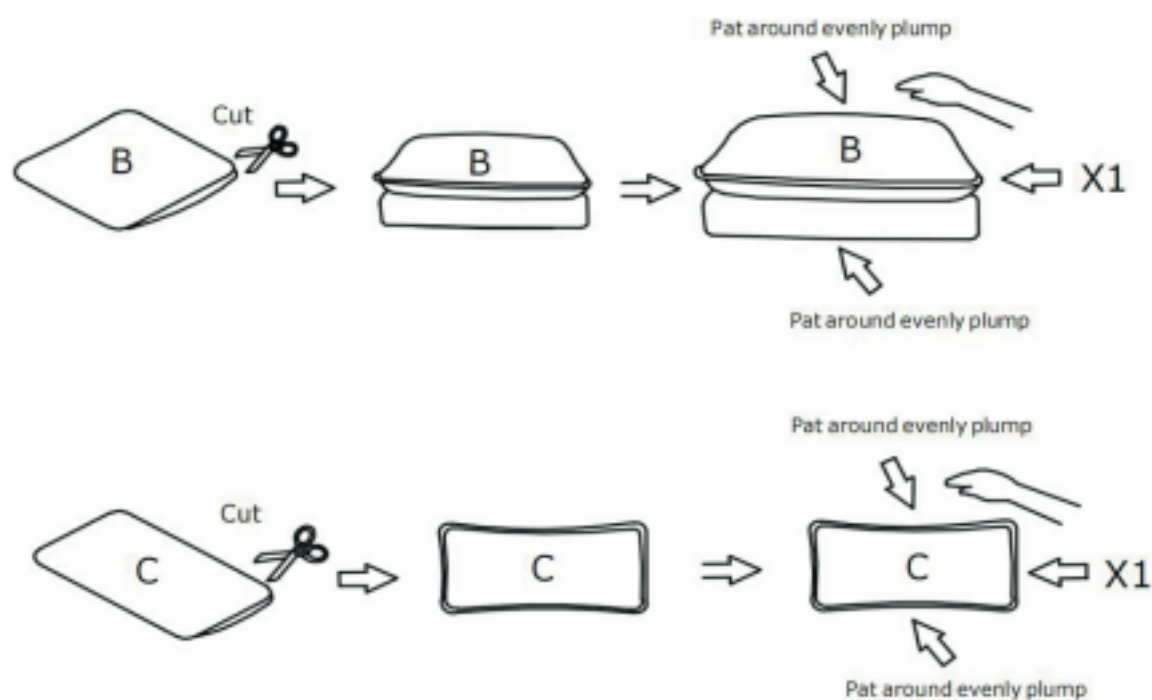

STEP 5: Place Seat cushion (B) and back cushion (C), and pillow (E) on sofa and make sure it's will fitted.

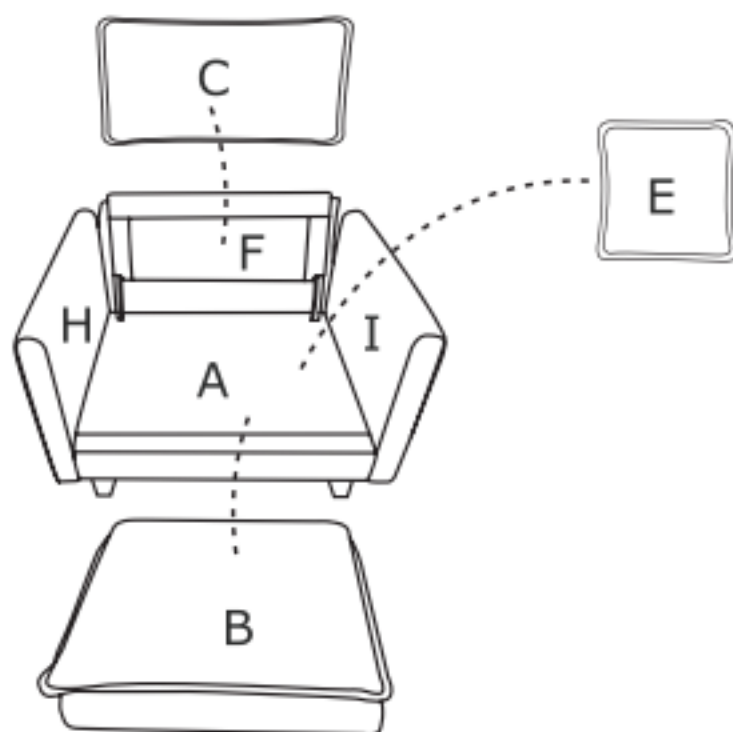

STEP 6: If the fabric has wrinkles, it will basically diappear after standing for 72 horus. Well done!! You can enjoy your leisure time on the sofa now.

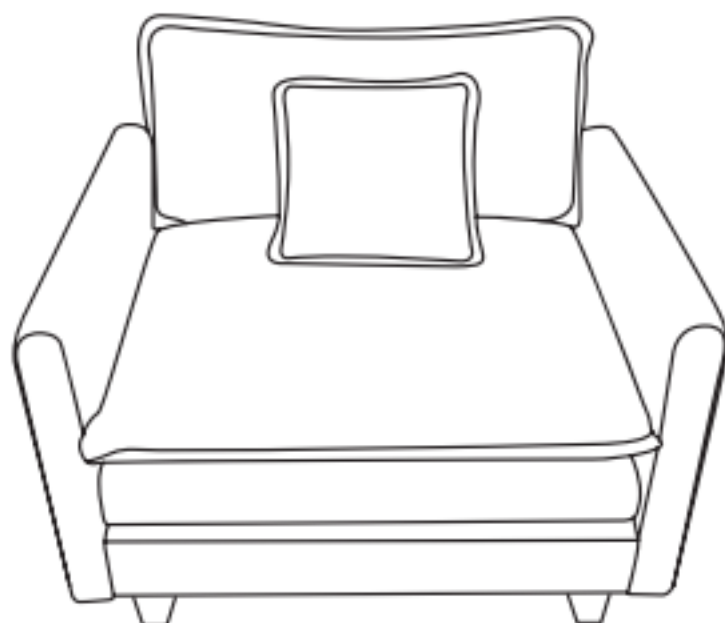

**IF YOU BUY 2 SEATER SOFA**  
**please follow below assembly instruction**

**Parts included**

**Parts List (BOX 1)**

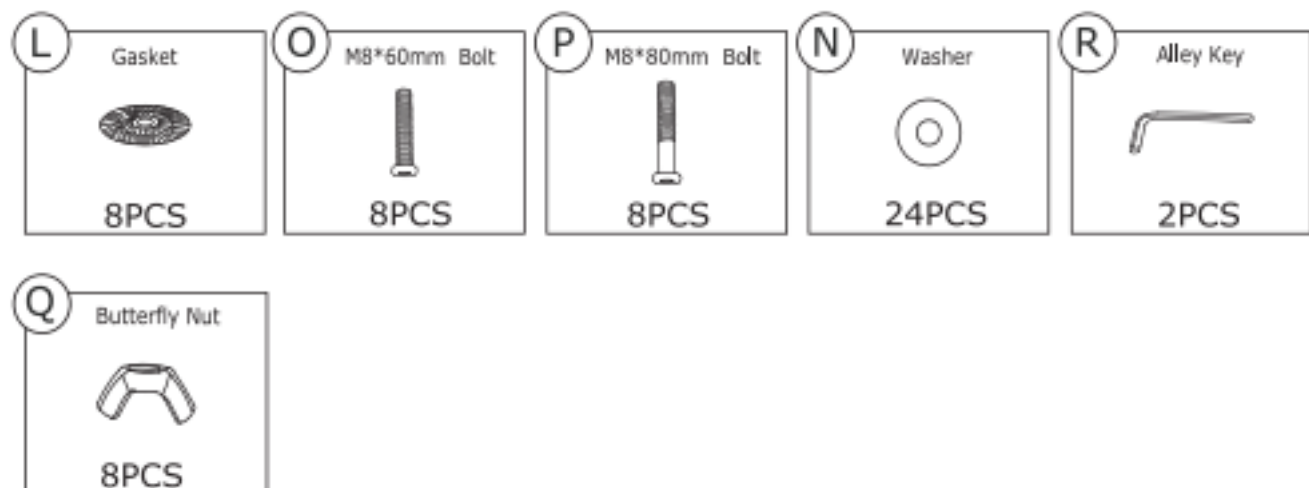
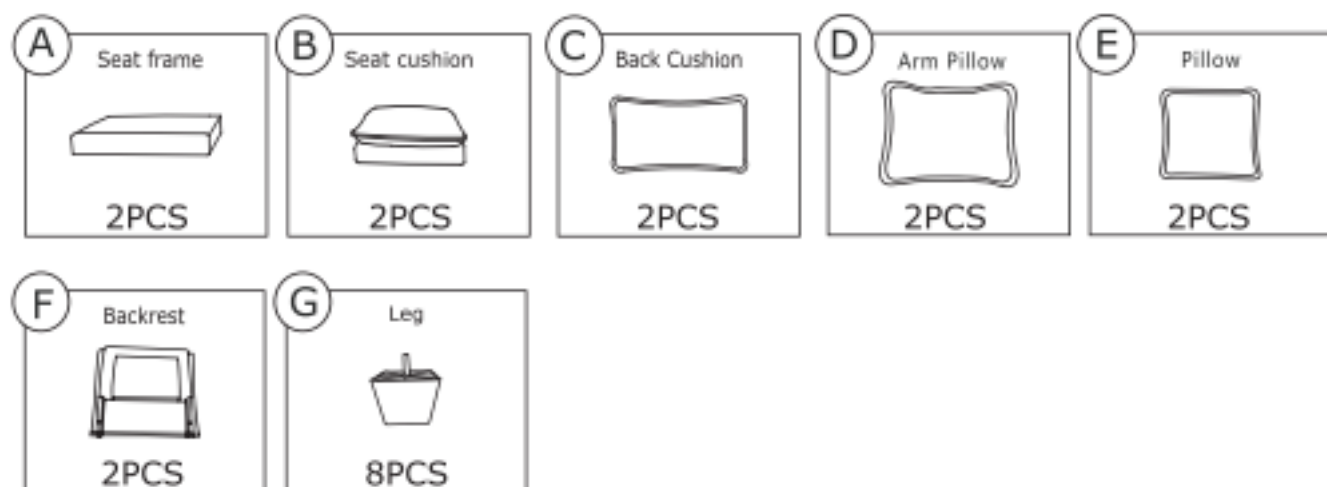

**Parts List (BOX 2)**

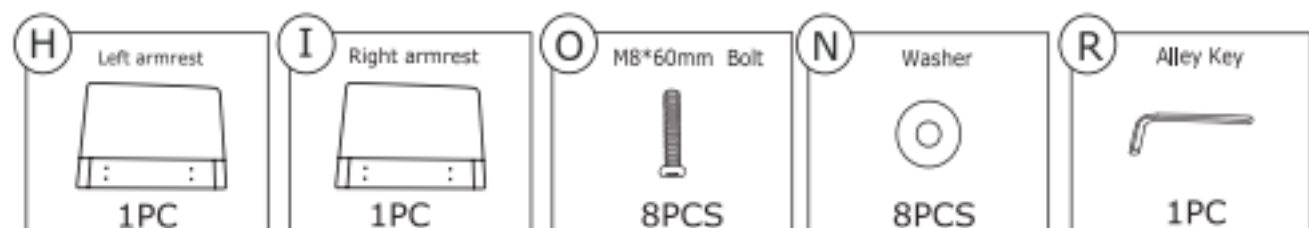

Note: Please retain all boxes until you are certain that your product isn't damaged and that you do not wish to return it. Disposal of boxes may prevent our ability to resolve your request.

## ASSEMBLY STEPS

STEP 1: Assemble the Left armrest (H) to the Seat frame (A) with Washers (N) and Bolts (O).

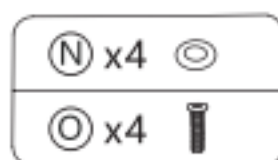
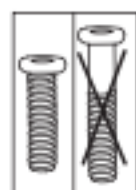
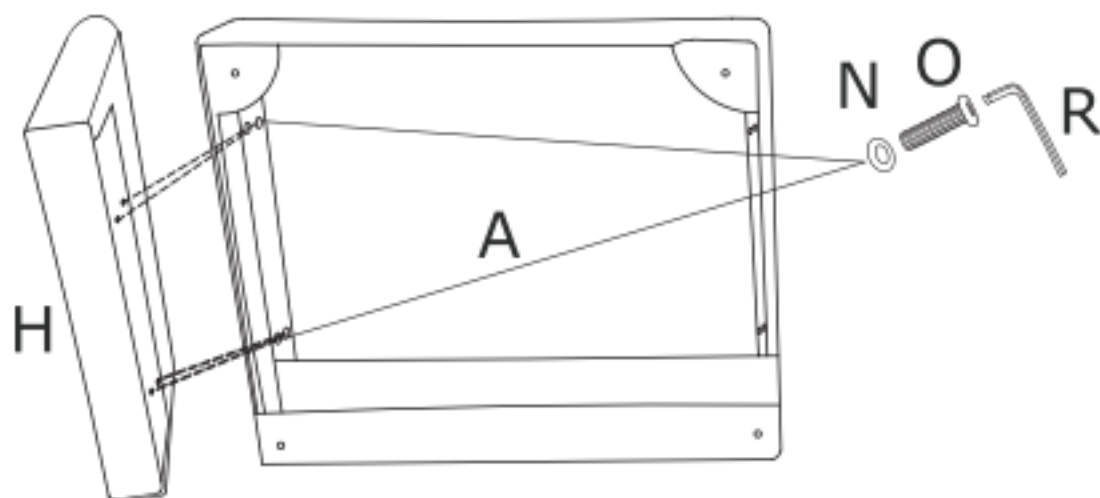

STEP 2: Assemble the Right armrest (I) to the Seat frame (A) with Washers (N) and Bolts (O).

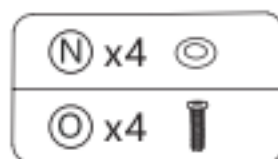
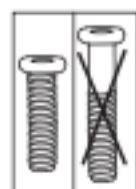
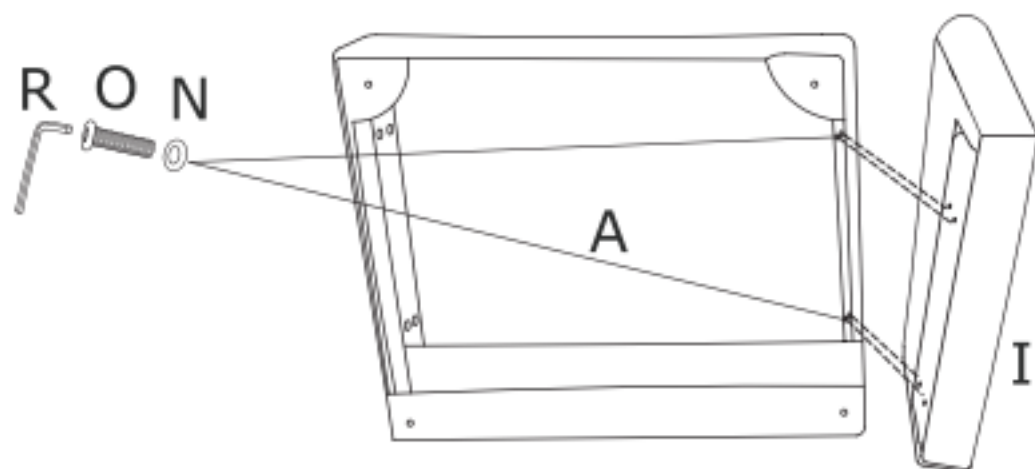

STEP 3: Assemble Seat frame (A) and Seat frame (A) with Butterfly nuts (Q) Washers (N) and Bolts (P).

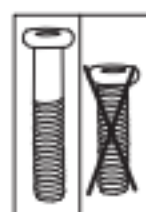
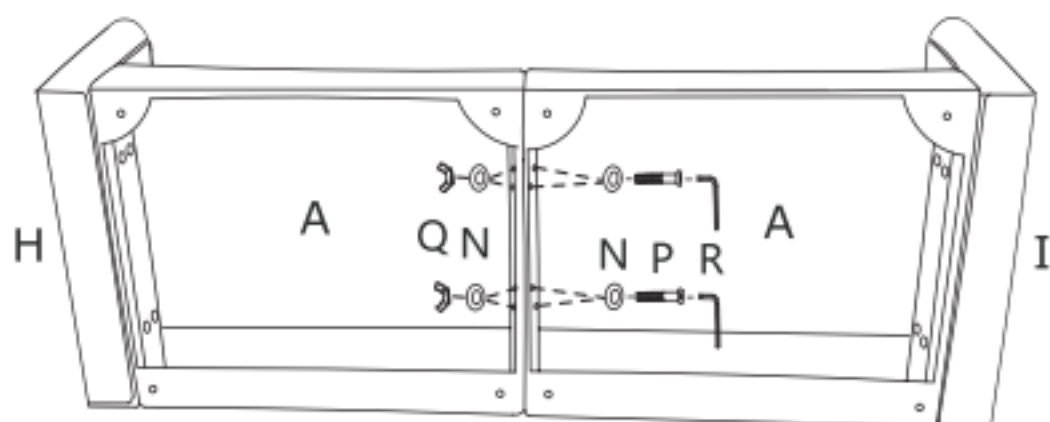

(N) 8	
(P) x 4	
(Q) x 4	

STEP 4: Assemble the Legs (G) on the sofa with Gaskets (L).

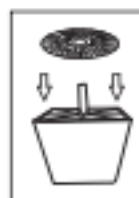
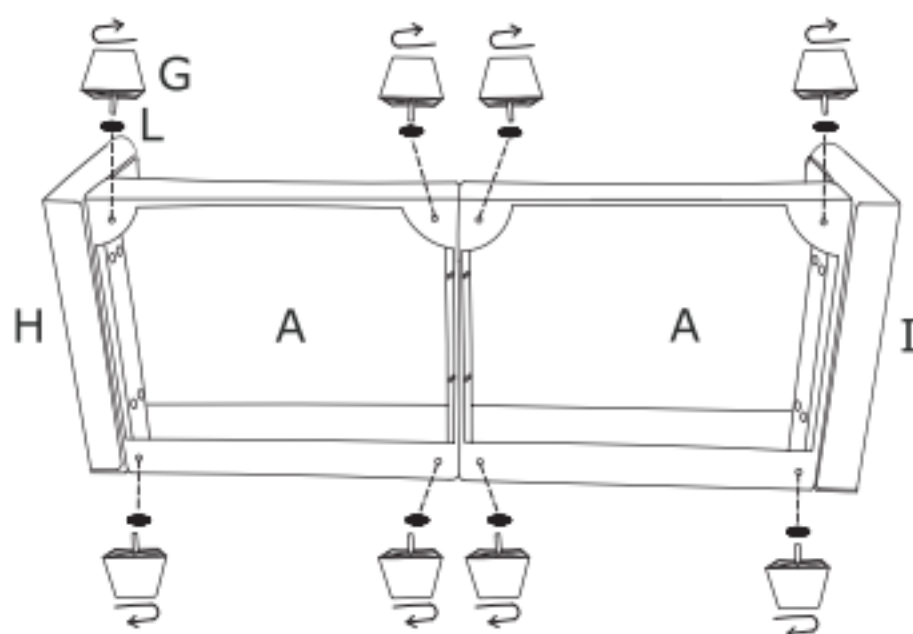

**STEP 5:** Insert the Backrest (F) into the designated holes, using Washer (N) and Bolts (O) to 70% tightness, and then tighten the all Bolts on the seat.

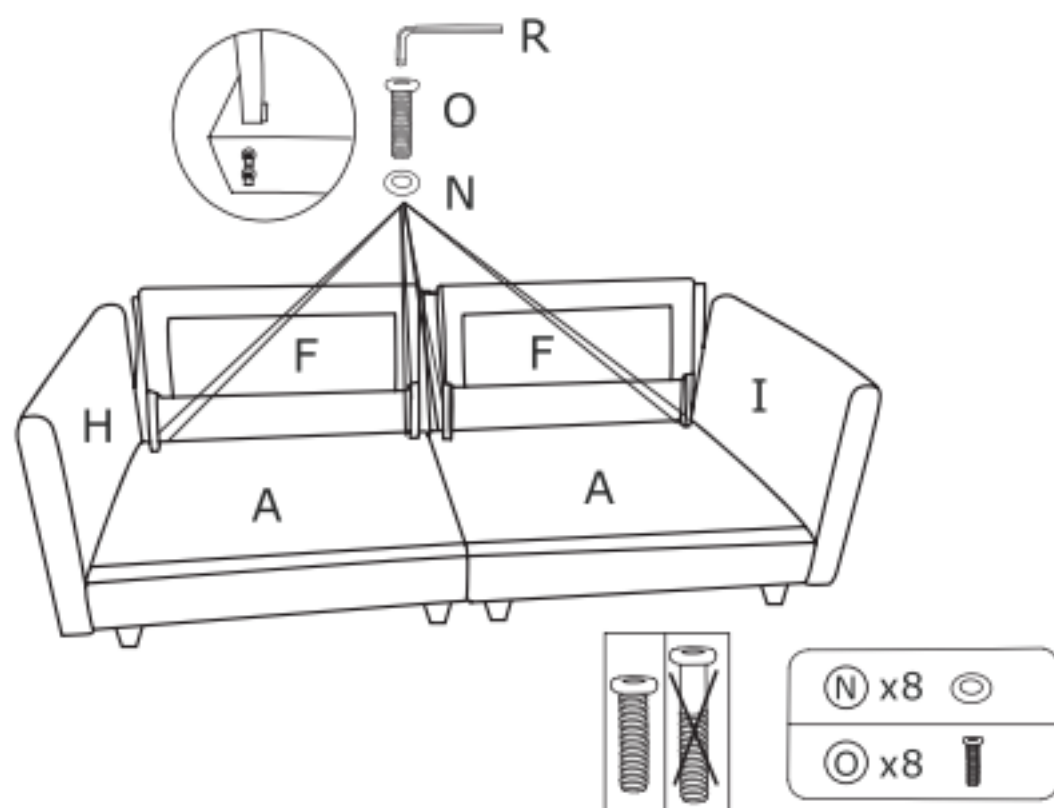

**STEP 6:** The cushion is packaged by vacuum compression. After cutting the package, it rebounds quickly within 4 hours. If the fabric has wrinkles, it will basically disappear after standing for 72 hours

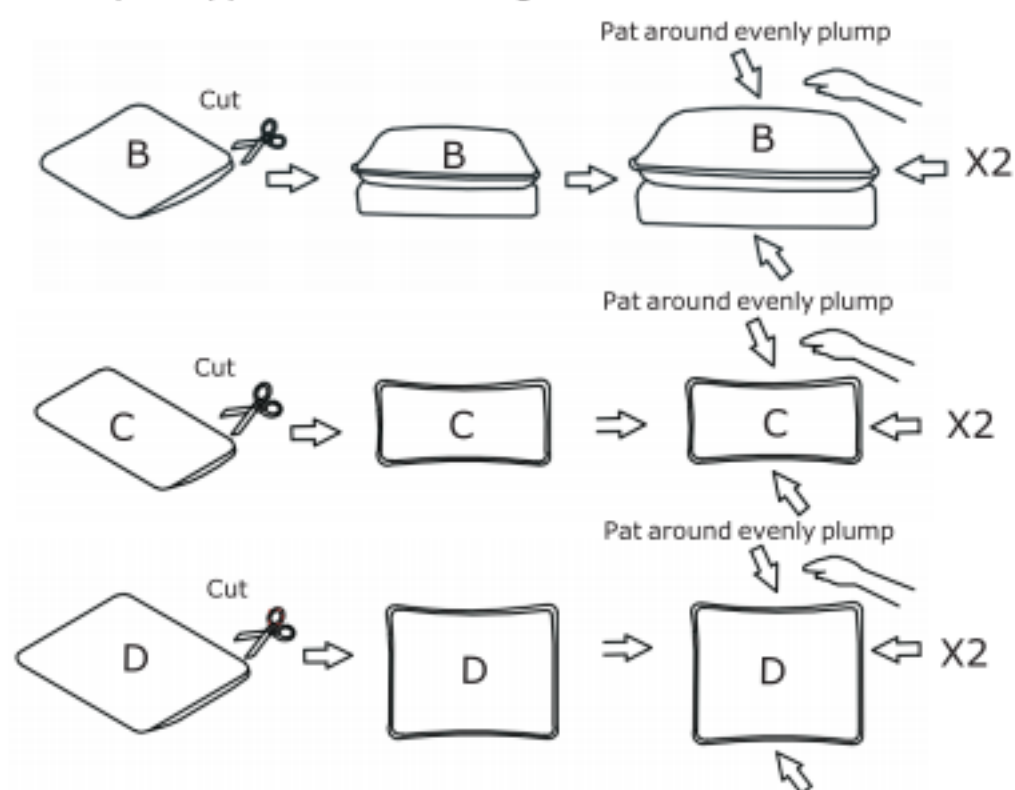

STEP 7: Place Seat cushions (B) and back cushions (C), on the sofa and make sure it's will fitted.

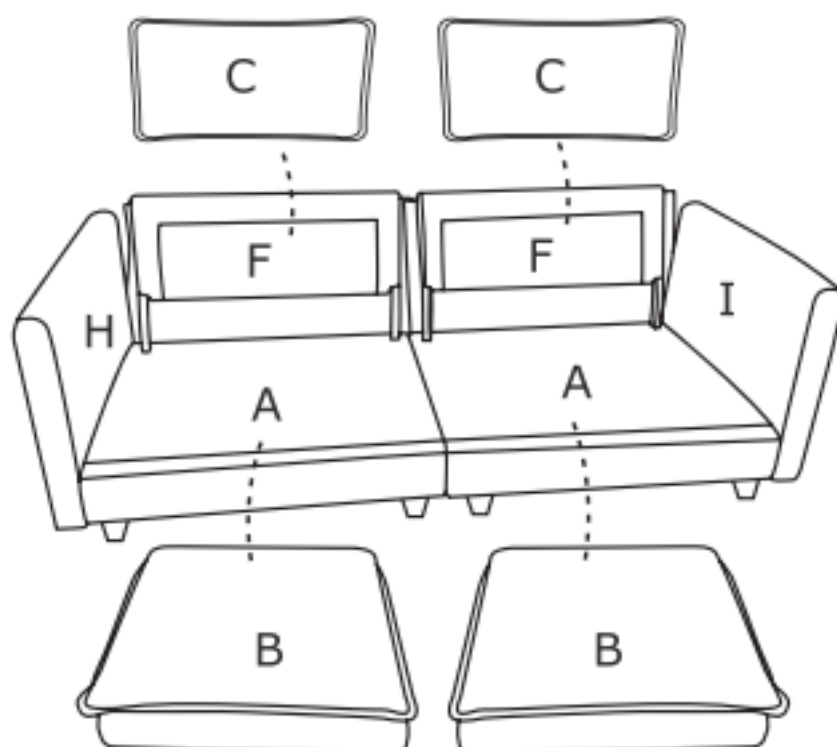



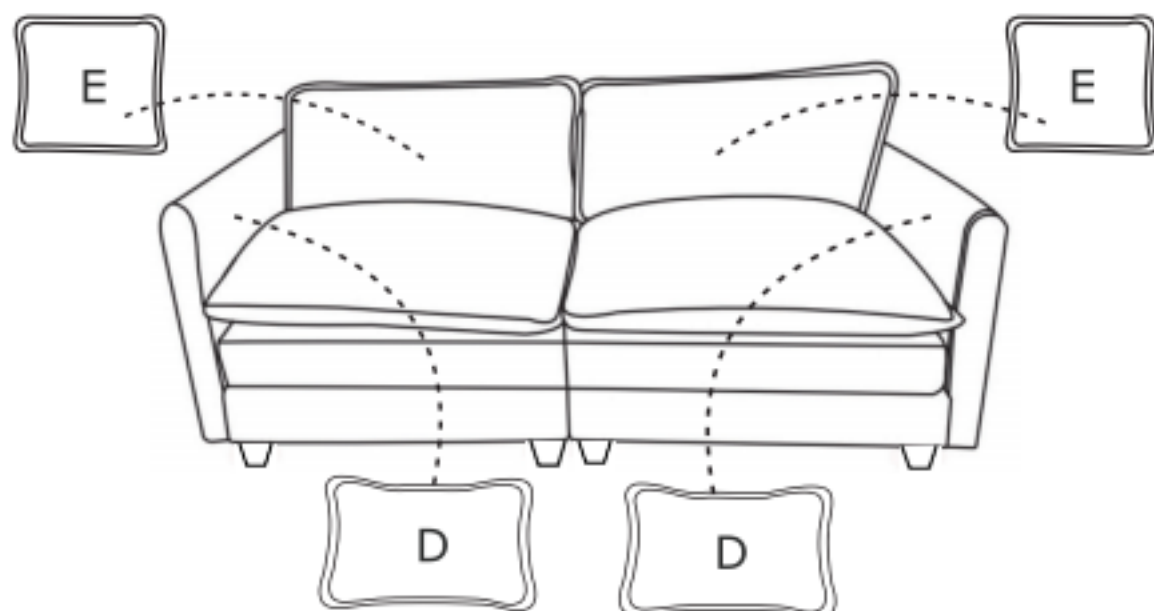







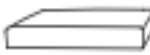

STEP 8: Place Pillows (E) and Pillows (D) on sofa and make sure it's will fitted.















**IF YOU BUY 3 SEATER SOFA**  
**please follow below assembly instruction**

**Parts incidued**

**Parts List (BOX 1)**





<b>A</b> Seat frame  2PCS	<b>B</b> Seat cushion  2PCS	<b>C</b> Back Cushion  2PCS	<b>D</b> Arm Pillow  2PCS	<b>E</b> Pillow  2PCS
<b>F</b> Backrest  2PCS	<b>G</b> Leg  8PCS	<b>L</b> Gasket  8PCS	<b>N</b> Washer  24PCS	<b>O</b> M8*60mm Bolt  8PCS
<b>P</b> M8*80mm Bolt  8PCS	<b>Q</b> Butterfly Nut  8PCS	<b>R</b> Alley Key  2PCS		

**Parts List (BOX 2)**

<b>A</b> Seat frame  1PC	<b>B</b> Seat cushion  1PC	<b>C</b> Back Cushion  1PC	<b>E</b> Pillow  1PC	<b>F</b> Backrest  1PC
<b>G</b> Leg  4PC	<b>L</b> Gasket  4PCS	<b>N</b> Washer  12PCS	<b>O</b> M8*60mm Bolt  4PCS	<b>P</b> M8*80mm Bolt  4PCS
<b>Q</b> Butterfly Nut  4PCS	<b>R</b> Alley Key  1PC			

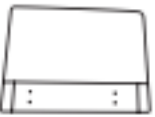
## PART LIST & HARDWARE

### Parts List (BOX 3)

<b>H</b> Left armrest  1PC	<b>I</b> Right armrest  1PC	<b>O</b> M8*60mm Bolt  8PCS	<b>N</b> Washer  8PCS	<b>R</b> Alley Key  1PC
--	---	---	--	---

Note: Please retain all boxes until you are certain that your product isn't damaged and that you do not wish to return it. Disposal of boxes may prevent our ability to resolve your request.

## ASSEMBLY STEPS

STEP 1: Assemble the Left armrest (H) to the Seat frame (A) with Washers (N) and Bolts (O).

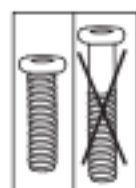
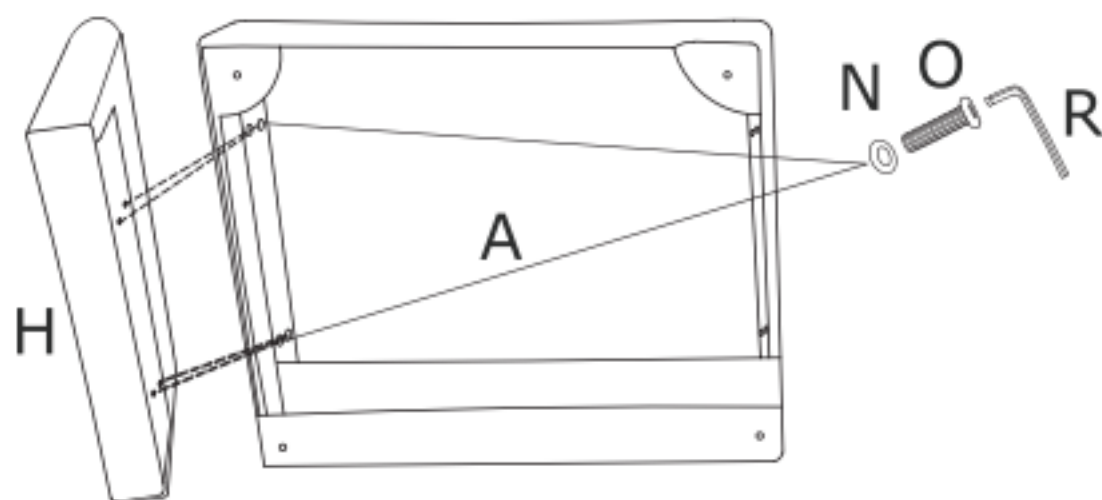

STEP 2: Assemble the Right armrest (I) to the Seat frame (A) with Washers (N) and Bolts (O).

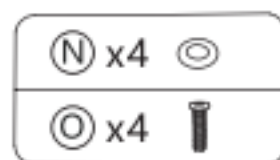
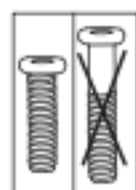
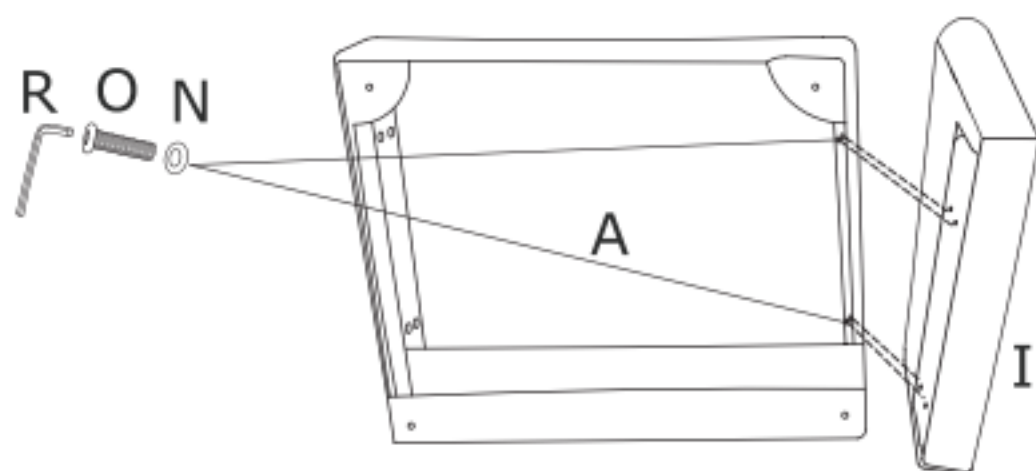

STEP 3: Assemble Seat frame (A) and Seat frame (A) with Butterfly nuts (Q) Washers (N) and Bolts (P).

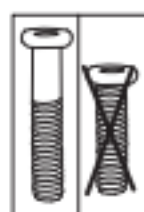
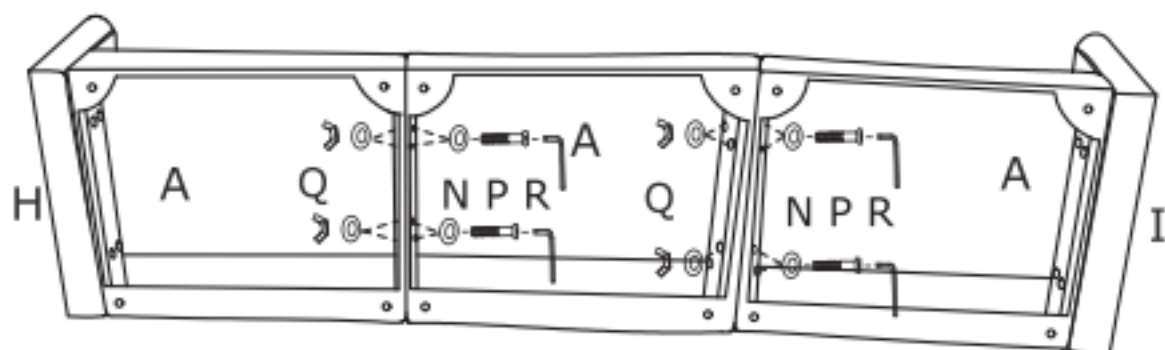

(N) x 16	⊙
(P) x 8	⌚
(Q) x 8	🦋

STEP 4: Assemble the Legs (G) on the sofa with Gaskets (L).

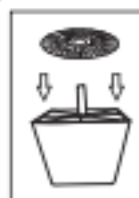
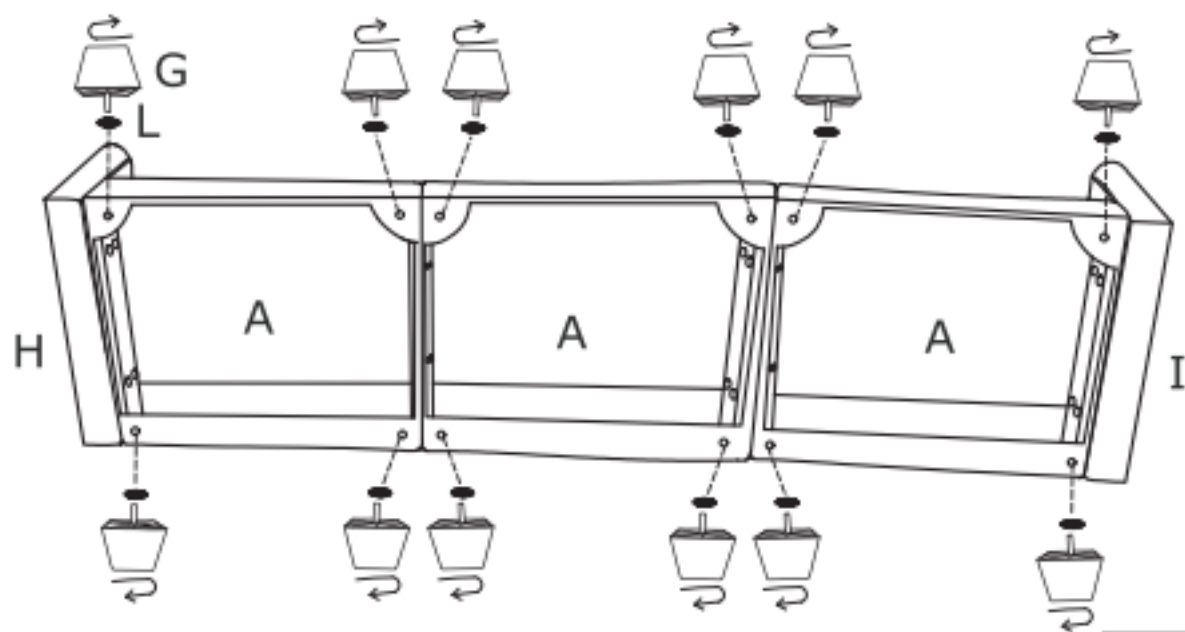

**STEP 5:** Insert the Backrest (F) into the designated holes, using Washer (N) and Bolts (O) to 70% tightness, and then tighten the all Bolts on the seat.

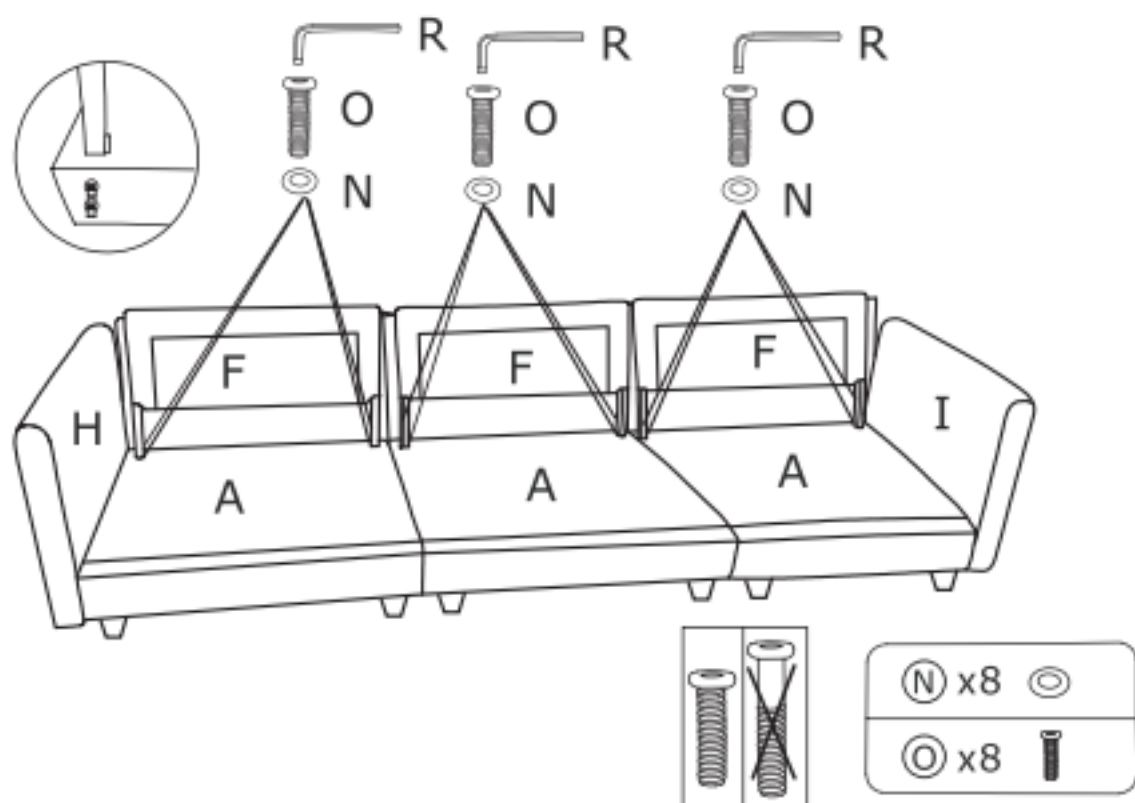

**STEP 6:** The cushion is packaged by vacuum compression. After cutting the package, it rebounds quickly within 4 hours. If the fabric has wrinkles, it will basically disappear after standing for 72 hours.

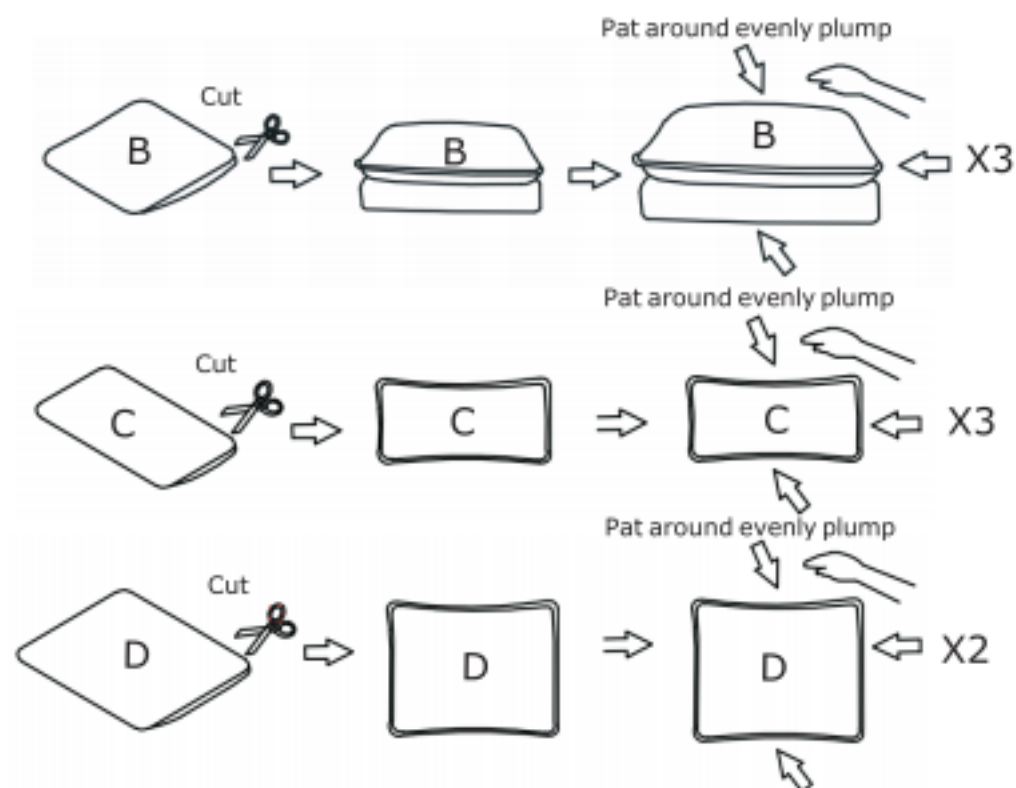

**STEP 7:** Place Seat cushions (B) and back cushions (C), and make sure it's will fitted.

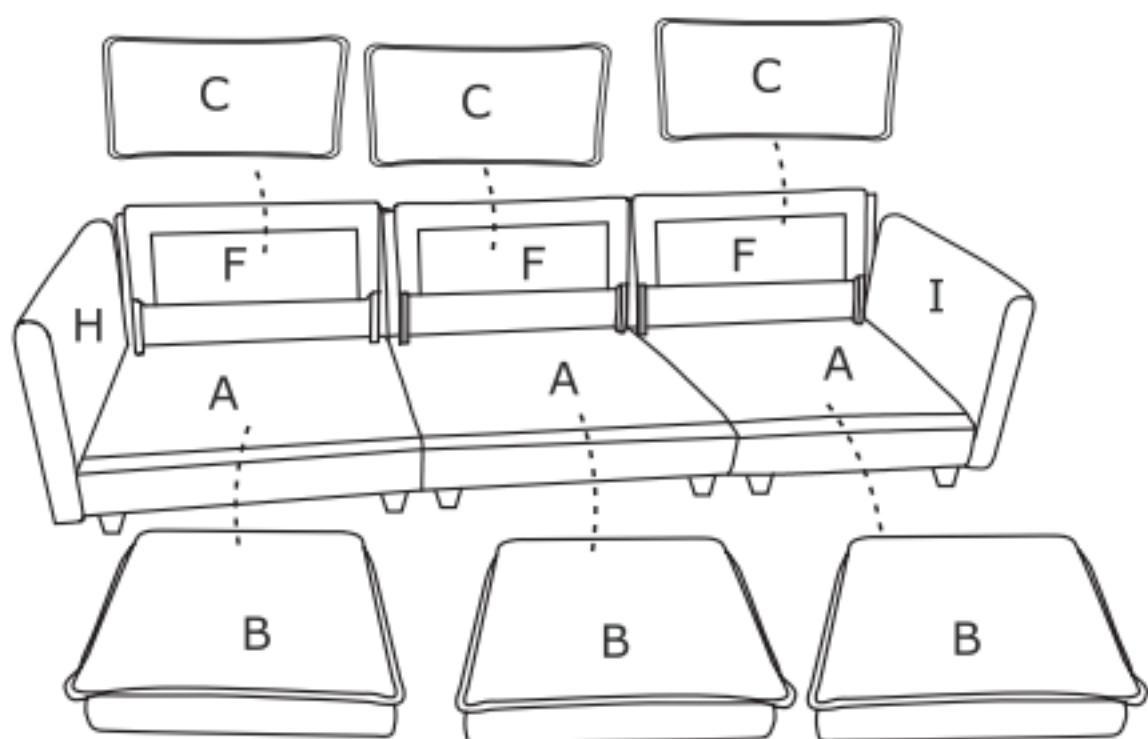



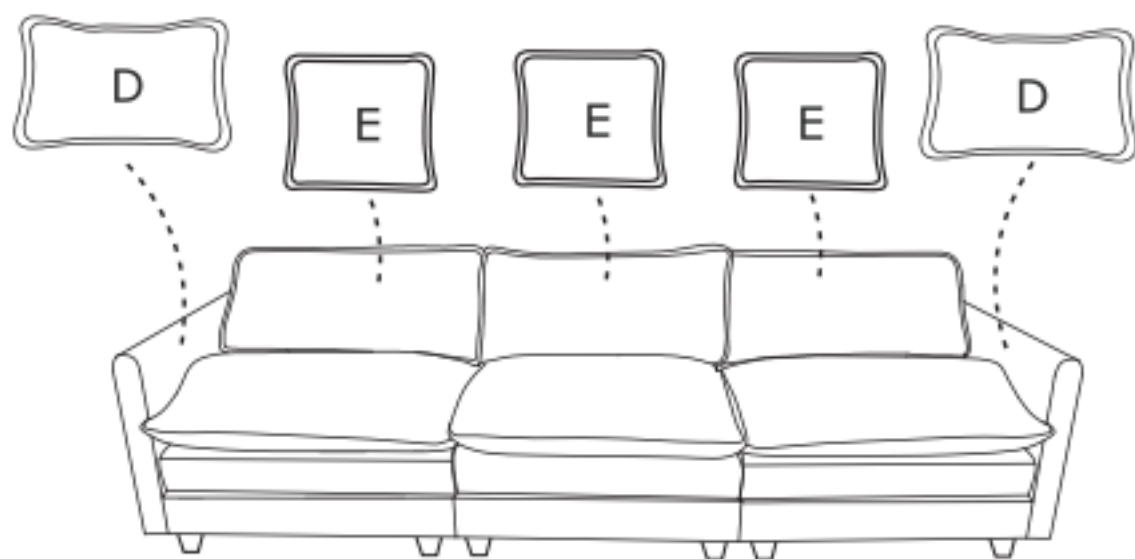









**STEP 8:** Place Pillows (E) and Pillows (D) on sofa and make sure it's will fitted.















**IF YOU BUY 4 SEATER SOFA**  
**please follow below assembly instruction**

**Parts incidued**

**Parts List (BOX 1)**











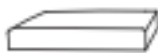

<b>A</b> Seat frame  2PCS	<b>B</b> Seat cushion  2PCS	<b>C</b> Back Cushion  2PCS	<b>D</b> Arm Pillow  2PCS	<b>E</b> Pillow  2PCS
<b>F</b> Backrest  2PCS	<b>G</b> Leg  8PCS	<b>L</b> Gasket  8PCS	<b>N</b> Washer  24PCS	<b>O</b> M8*60mm Bolt  8PCS
<b>P</b> M8*80mm Bolt  8PCS	<b>Q</b> Butterfly Nut  8PCS	<b>R</b> Alley Key  2PCS		

**Parts List (BOX 2)**





<b>A</b> Seat frame  1PC	<b>B</b> Seat cushion  1PC	<b>C</b> Back Cushion  1PC	<b>E</b> Pillow  1PC	<b>F</b> Backrest  1PC
<b>G</b> Leg  4PC	<b>L</b> Gasket  4PCS	<b>N</b> Washer  12PCS	<b>O</b> M8*60mm Bolt  4PCS	<b>P</b> M8*80mm Bolt  4PCS
<b>Q</b> Butterfly Nut  4PCS	<b>R</b> Alley Key  1PC			

## PART LIST & HARDWARE

### Parts List (BOX 3)

<b>A</b> Seat frame  1PC	<b>B</b> Seat cushion  1PC	<b>C</b> Back Cushion  1PC	<b>E</b> Pillow  1PC	<b>F</b> Backrest  1PC
<b>G</b> Leg  4PC	<b>L</b> Gasket  4PCS	<b>N</b> Washer  12PCS	<b>O</b> M8*60mm Bolt  4PCS	<b>P</b> M8*80mm Bolt  4PCS
<b>Q</b> Butterfly Nut  4PCS	<b>R</b> Alley Key  1PC			

### Parts List (BOX 4)

<b>H</b> Left armrest  1PC	<b>I</b> Right armrest  1PC	<b>O</b> M8*60mm Bolt  8PCS	<b>N</b> Washer  8PCS	<b>R</b> Alley Key  1PC
--	---	---	--	---

Note: Please retain all boxes until you are certain that your product isn't damaged and that you do not wish to return it. Disposal of boxes may prevent our ability to resolve your request.

## ASSEMBLY STEPS

**STEP 1:** Assemble the Left armrest (H) to the Seat frame (A) with Washers (N) and Bolts (O).

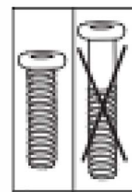
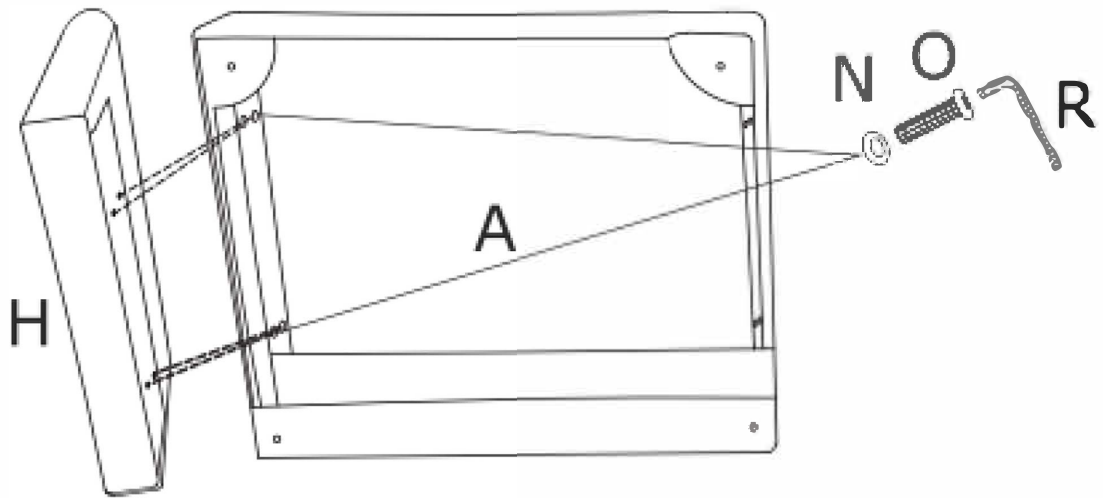

**STEP 2:** Assemble the Right armrest (I) to the Seat frame (A) with Washers (N) and Bolts (O).

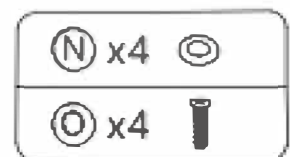
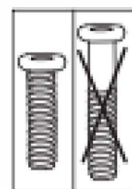
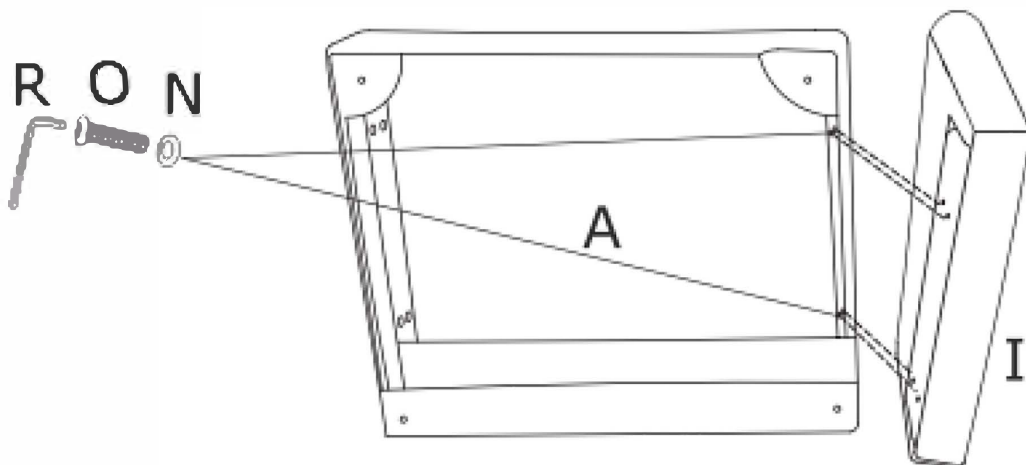

STEP 3: Assemble Seat frame (A) and Seat frame (A) with Butterfly nuts (Q) Washers (N) and Bolts (P).

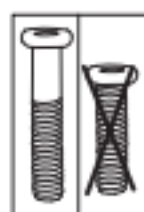
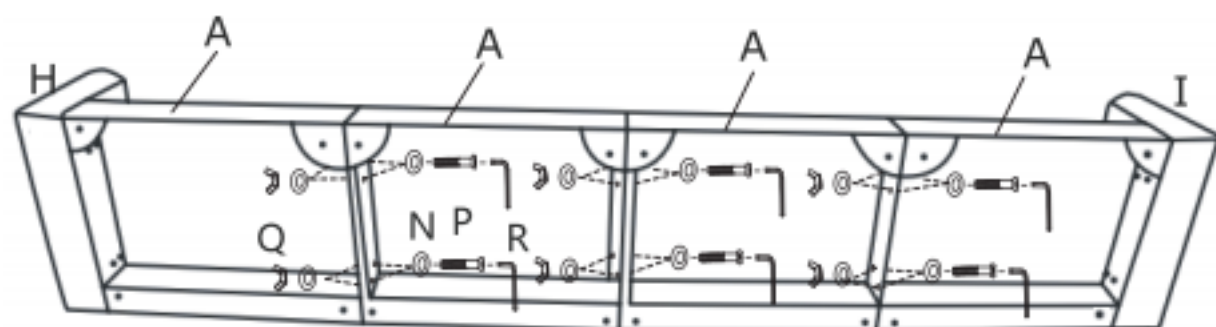

(N) x 24	⊙
(P) x 12	⌋
(Q) x 12	⌋

STEP 4: Assemble the Legs (G) on the sofa with Gaskets (L).

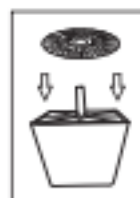
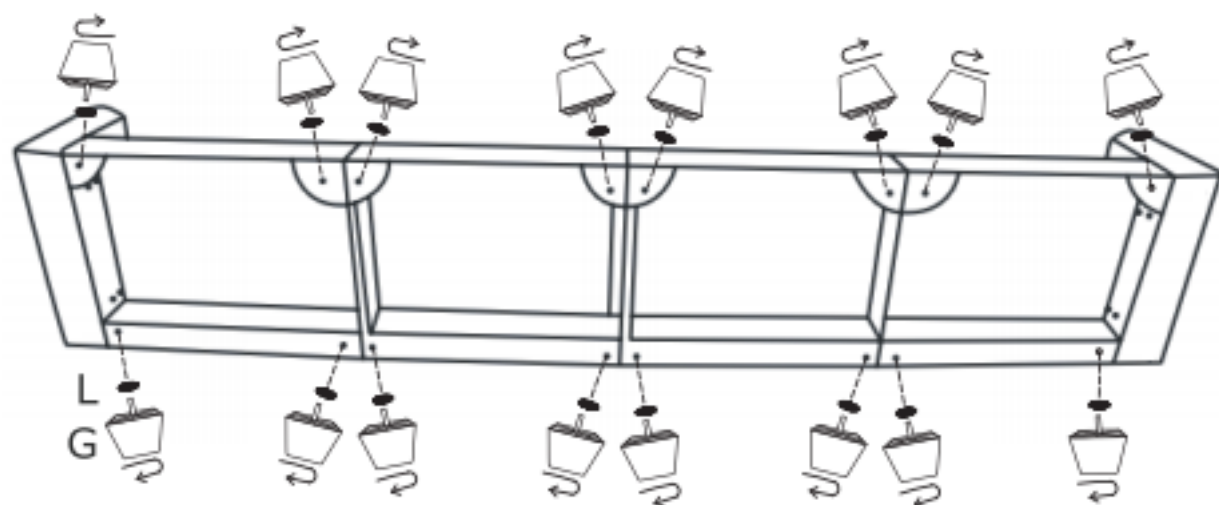

**STEP 5:** Insert the Backrest (F) into the designated holes, using Washer (N) and Bolts (O) to 70% tightness, and then tighten the all Bolts on the seat.

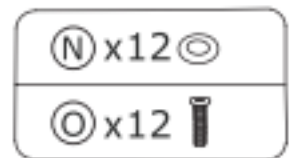
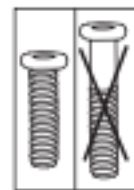
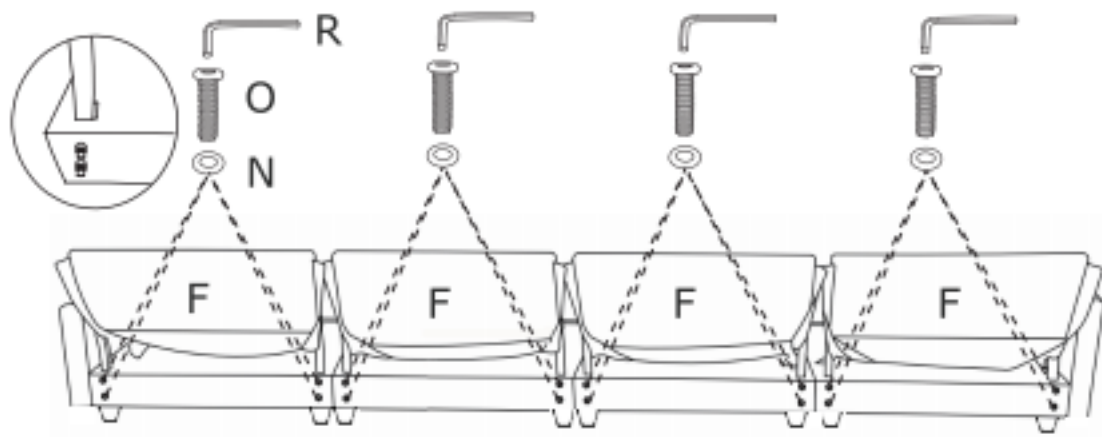

**STEP 6:** The cushion is packaged by vacuum compression. After cutting the package, it rebounds quickly within 4 hours. If the fabric has wrinkles, it will basically disappear after standing for 72 hours

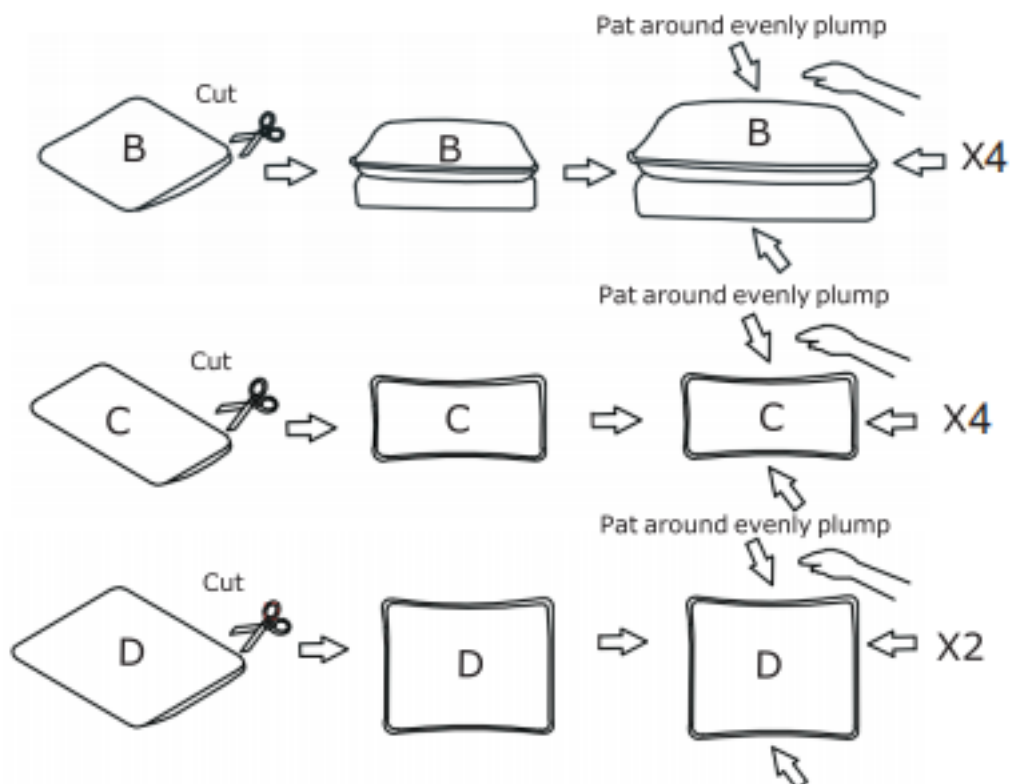

**STEP 7:** Place Seat cushions (B) and back cushions (C), and make sure it's will fitted.

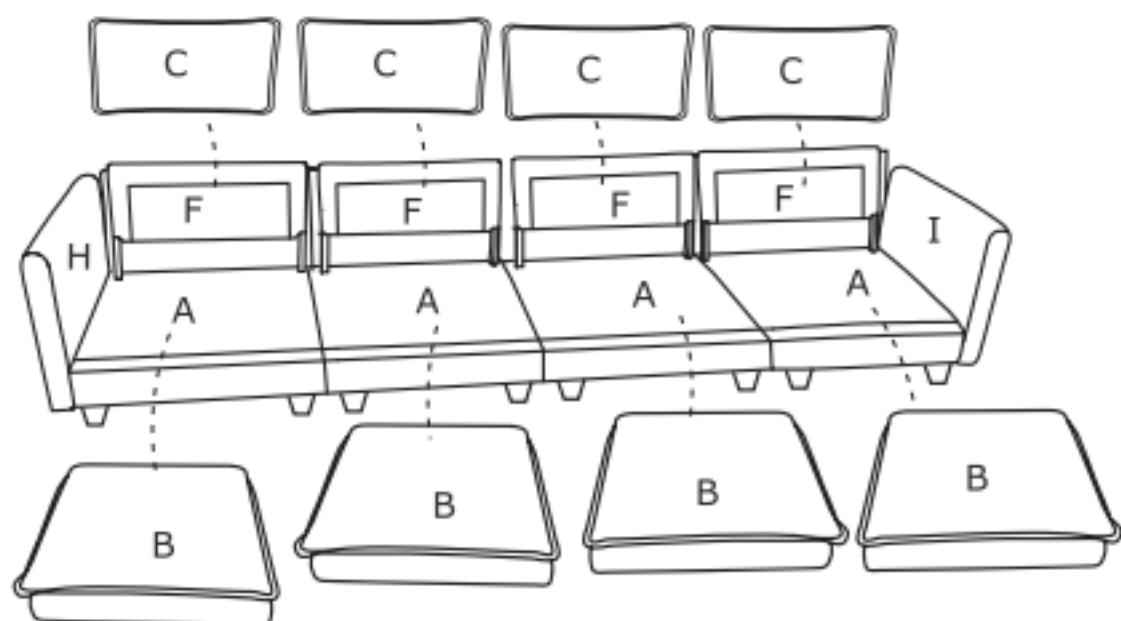

**STEP 8:** Place Pillows (E) and Pillows (D) on sofa and make sure it's will fitted.

