

Patio Recliner Chair

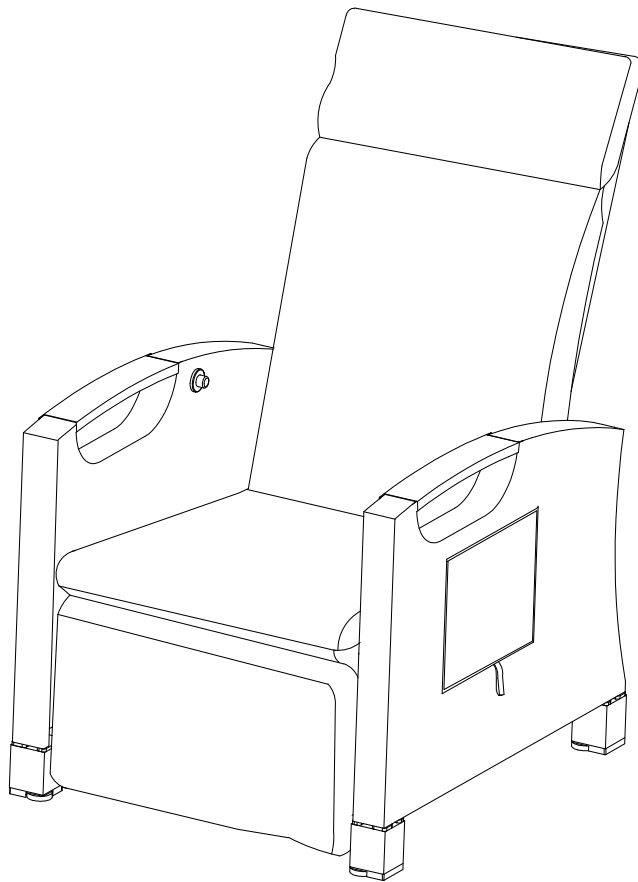



ASSEMBLY MANUAL



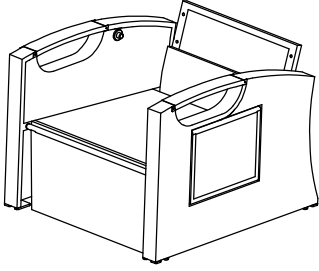
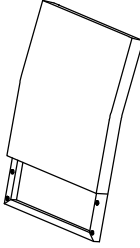
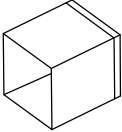
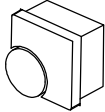
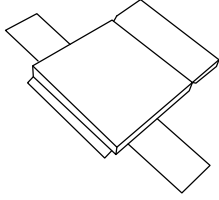
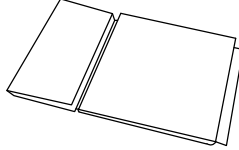
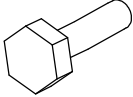

READ & SAVE BELOW INSTRUCTIONS BEFORE ASSEMBLY

1. PLEASE SEPARATE AND IDENTIFY ALL PARTS, MAKING SURE THAT YOU HAVE ALL OF THE PARTS LISTED.
2. TO AVOID ANY SCRATCH DURING ASSEMBLY, PLEASE ASSEMBLE ON A SOFT MAT OR SIMILAR.
3. PLEASE ASSEMBLE STEP BY STEP AND FOLLOW THE INSTRUCTIONS.
4. WASHERS MUST BE USED.
5. WHILE EACH SCREW AND NUT IS PROPERLY FASTENED, DO NOT OVER FASTEN IT.
6. DO NOT COMPLETELY FASTEN EACH SCREW AND NUT UNTIL ALL THE SCREWS ARE PROPERLY FIXED.

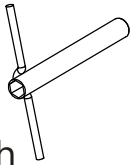
 <p>① 1X Seat</p>		 <p>② 1X Seatback</p>	
 <p>③ 4X Foot Kit</p>	 <p>④ 4X Foot Pad</p>	 <p>⑤ 1X Backrest Cushion</p>	 <p>⑥ 1X Seat Cushion</p>
 <p>Ⓐ 4X Screw M6X20</p>		 <p>Ⓑ 4X Screw M6X32</p>	
 <p>Ⓒ 8X Washer D6</p>		 <p>Ⓓ 1X Hex Wrench S4</p>	
 <p>Ⓔ 1X Wrench M6</p>			

Install all the relevant screws, but do not tighten them completely at the very beginning. Tighten the screws fully one by one.

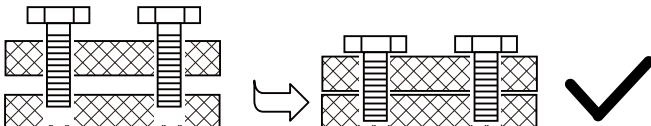

Don't tighten up the screw before you start next mounting during the installation.

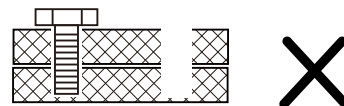

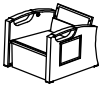

① 1X



③ 4X



④ 4X

M6X20



⑤ 4X

D6



⑥ 1X

M6

Step1

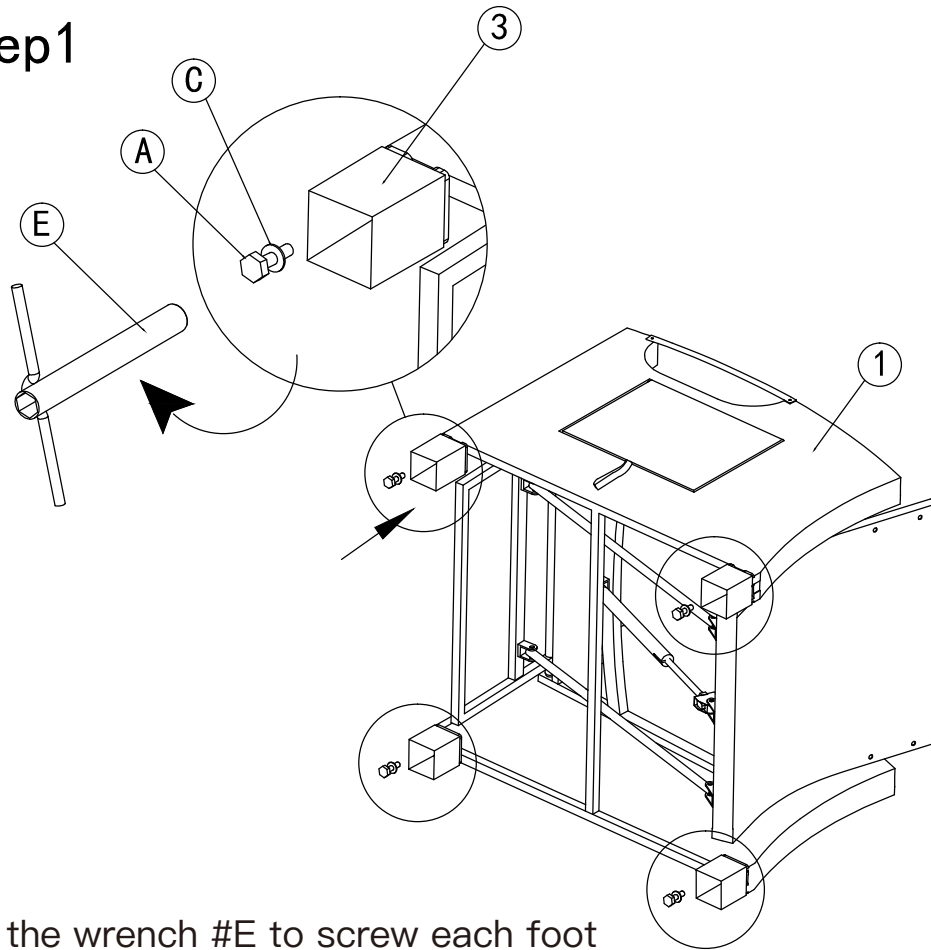

Use the wrench #E to screw each foot kit #③ to the seat #① with screw #A and washer #C.





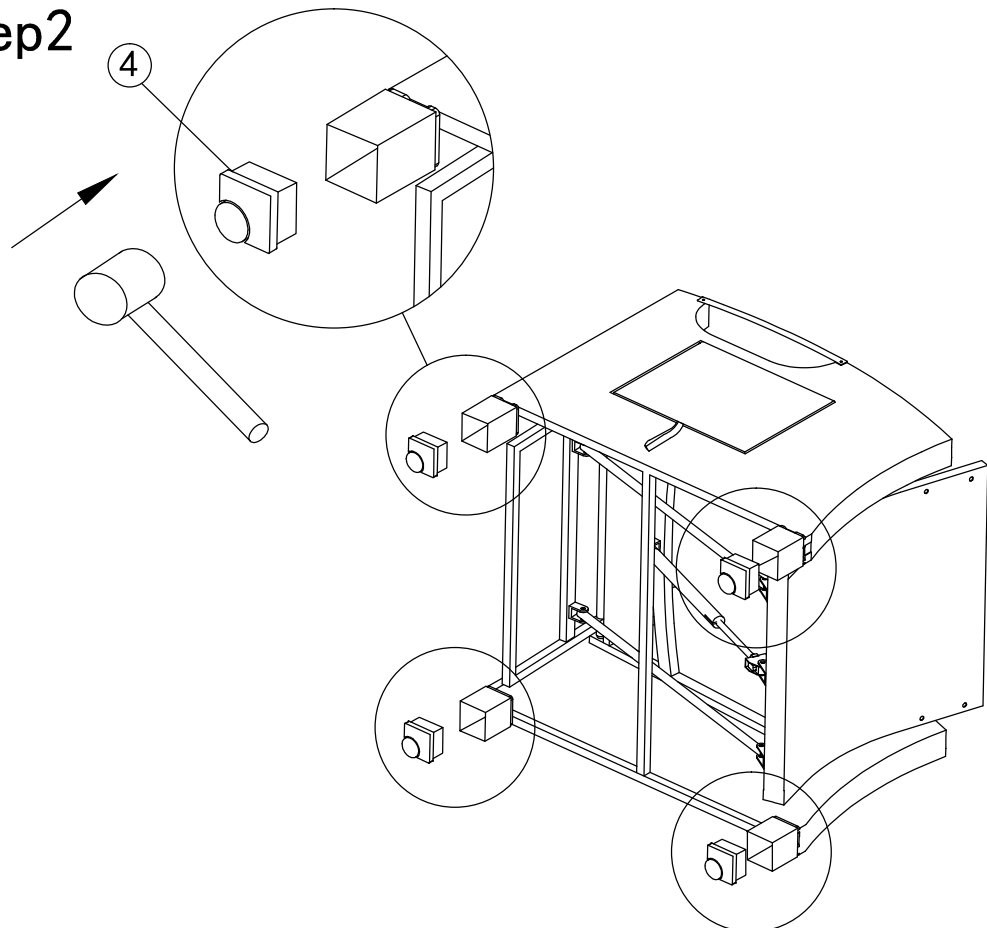

④ 4X

Step2

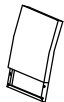

Use a hammer to drive each foot pad #④ into each foot kit.

- ② 1X 
- ③ 4X M6X32 
- ④ 4X D6 
- ⑤ 1X S4 

Step3

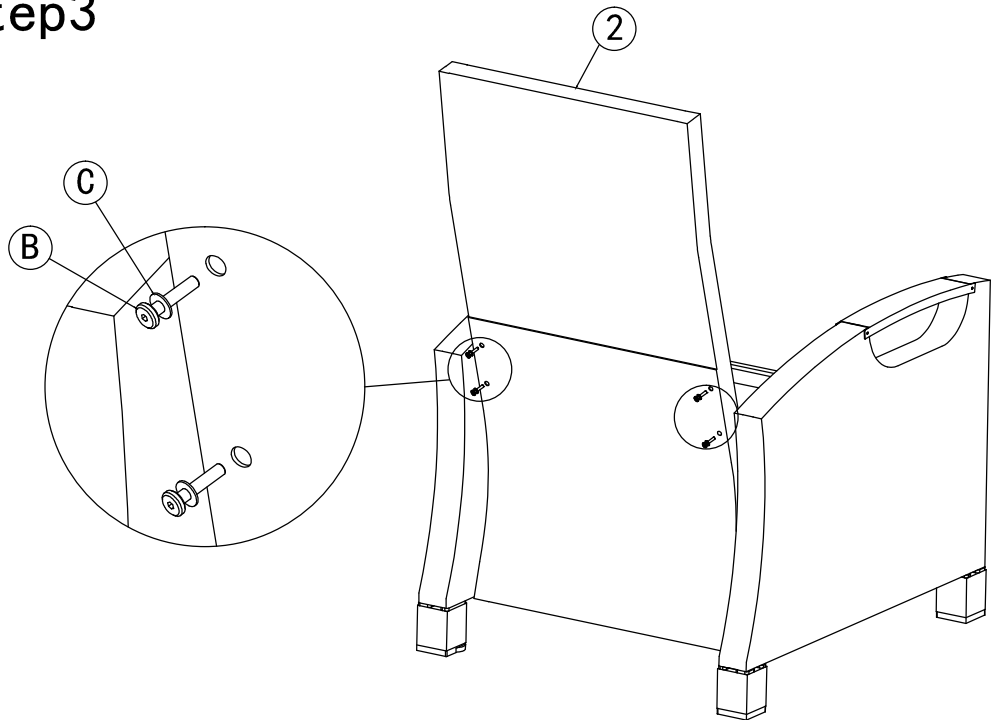

Use hex wrench #D to screw the seatback #② to the seat with screws #B and washers C.

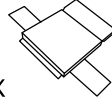
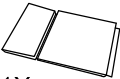
- ⑥ 1X 
- ⑦ 1X 

Step4

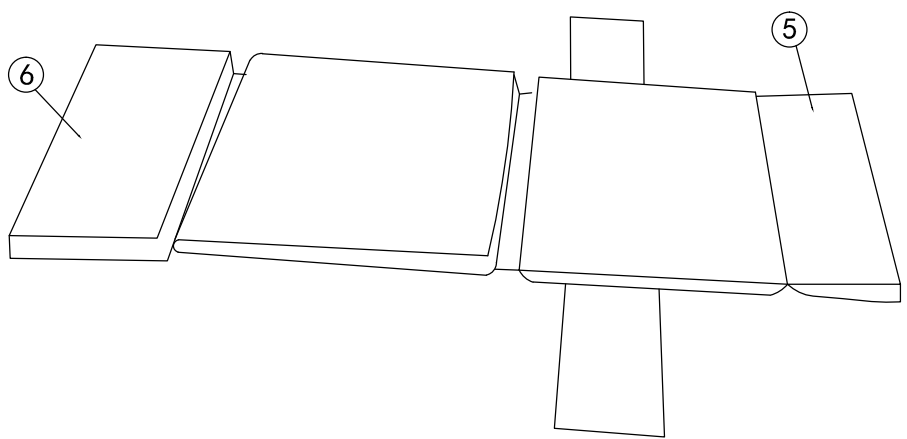

Attach the two cushions with the Velcro in the center.

Step5

Secure the cushion to the chair.

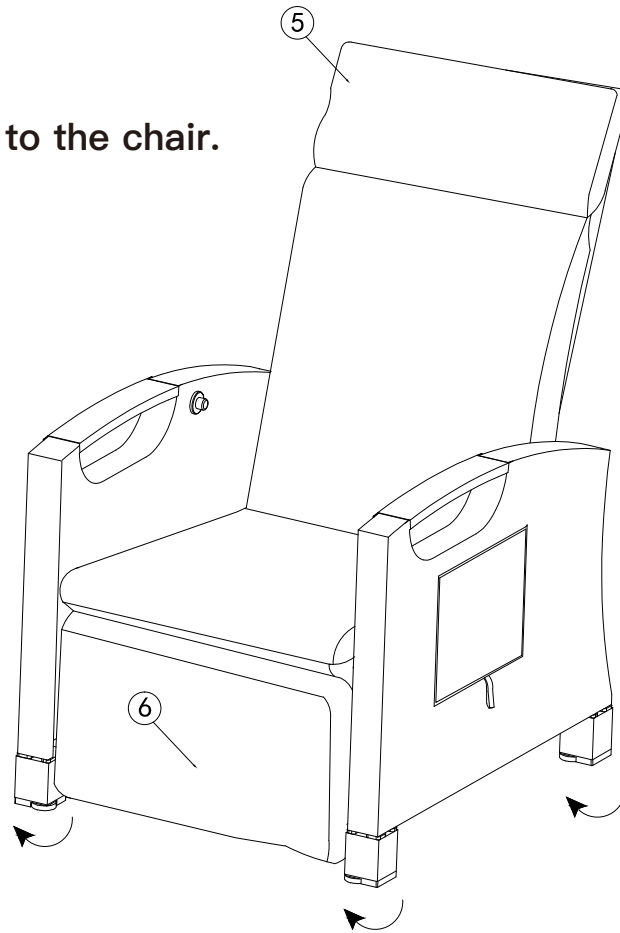

Adjustable foot pads to adjust the height of the chair legs as required.

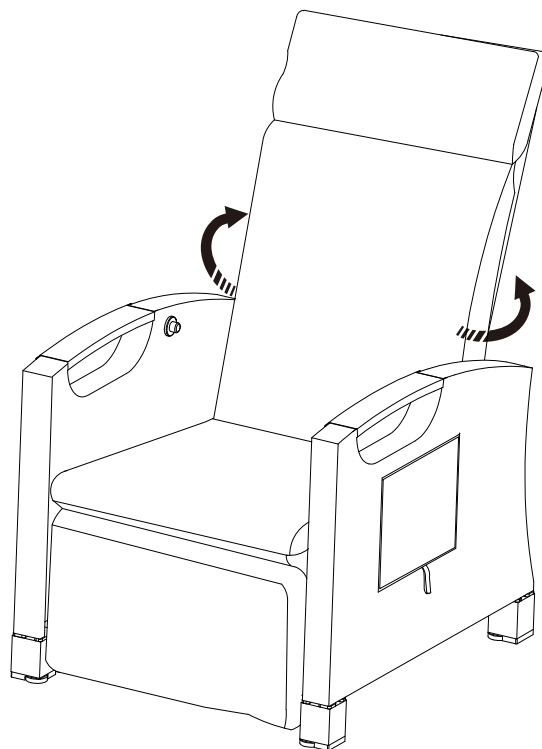

CARE AND CLEANING:

1. TO CLEAN,WIPE WITH DAMP CLOTH.DO NOT USE BLEACH,ACID SOLVENTS OR ABRASIVE CLEANERS OR FRAME PARTS.
2. DURING VARYING WEATHER CONDITIONS AND WINTER PERIOD,WE STRONGLY RECOMMEND THAT IT CAN BE STORED IN A DRY AREA WITH A SUITABLE COVER BEFORE STORAGE,PLS INSURE IT IS CLEAN AND DRY.
3. IN THE EVENT OF BARE METAL SHOWING DUE TO SCRATCH,IT IS PREFERRED TO TREAT WITH A RUST REPELLING VARNISH OR SIMILAR.
4. PERIODICALLY CHECK AND ENSURE THAT ALL THE SCREWS ARE COMPLETELY TIGHTEN.