

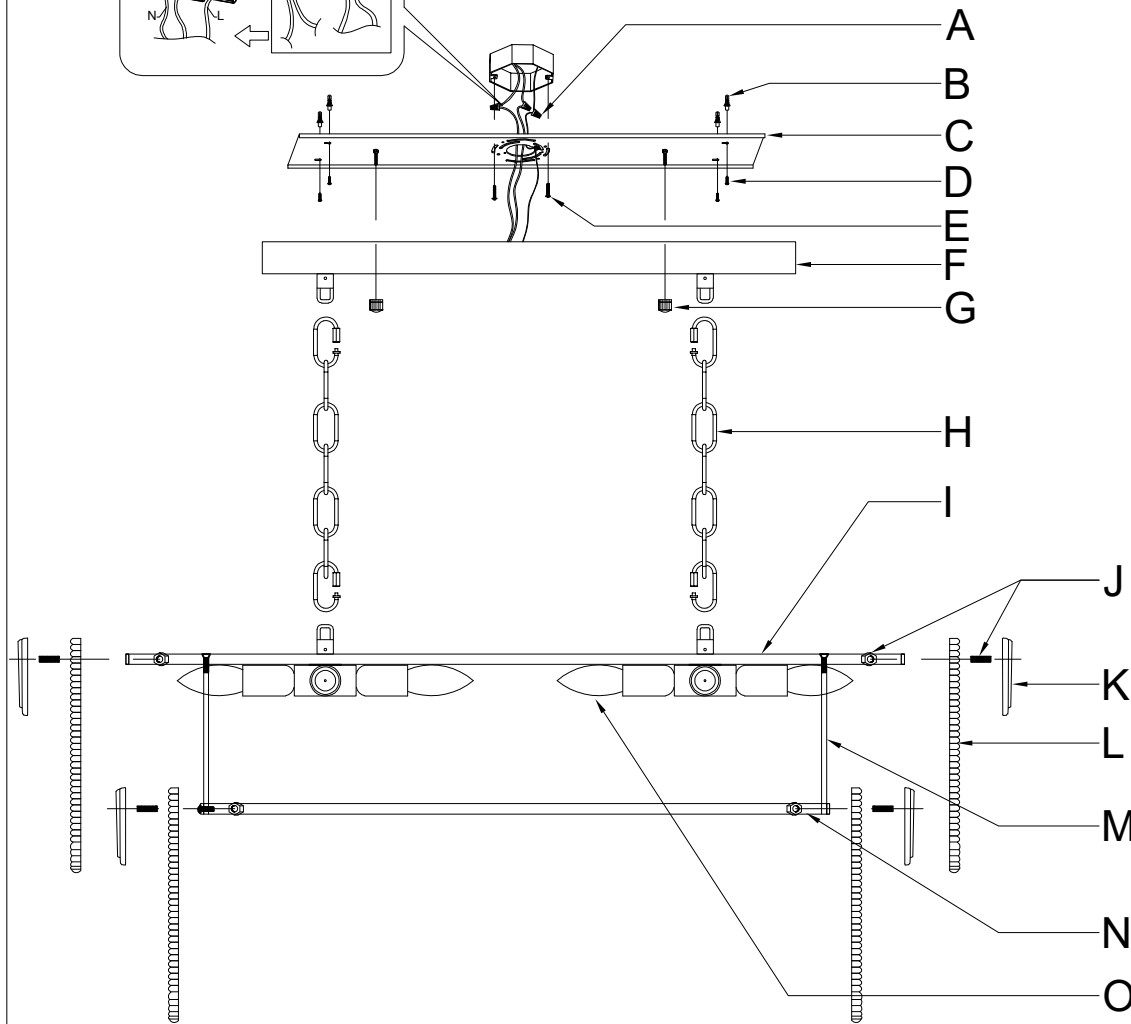

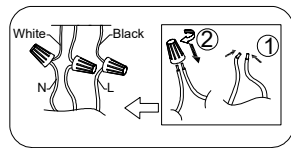











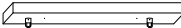

Installation instructions

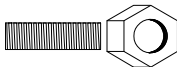
Input voltage: 110-120V 60Hz
8×E12×Max 40W

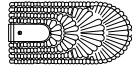

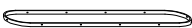
Parts list:

			
A ×3	B ×4	C ×1	D ×4
			
E ×4	F ×1	G ×2	H ×2
			
I ×1	J ×28	K ×28	L ×28
			
M ×4	N ×1	O ×8	

Tools:

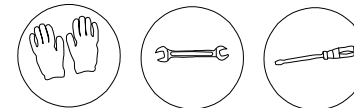

Note:

1. The lamps may only be installed by authorized and qualified technicians according to the valid regulations for electrical installation.
2. The manufacturer does not accept any responsibility for injuries or damage resulting from improper use of the light.
3. Attention! Before starting the installation work, make sure that the mains power line is voltage-free - turn off safety cutout or unscrew the protection fuse. The switch must be "OFF".
4. Warning! Before drilling the mounting holes, make sure that no gas, water or electricity pipes and wires can be drilled through or damaged in your chosen mounting location.
5. Description of the supply terminals: L = Phase N = Neutral conductor = Earthed conductor.

