



**INSTRUCTIONS D'ASSEMBLAGE
ASSEMBLY INSTRUCTIONS**

**LIT -
QUEEN / TETE DE LIT SEULEMENT SIMILI-CUIR
BLANC**

**BED -
QUEEN SIZE / WHITE LEATHER-LOOK HEADBOARD
ONLY**



**POUR DE L'ASSISTANCE OU POUR COMMANDER
CONTACTEZ NOTRE DÉPARTEMENT
LA CLIENTÈLE.**

**FOR TO ORDER PARTS
CUSTOMER SERVICE DEPARTMENT**

LISTE DES PIÈCES
PARTS LIST

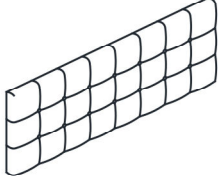
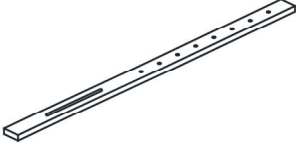
PIÈCE / PART #	IMAGE	DESCRIPTION	QTY / QTÉ
1		HEADBOARD TÊTE DE LIT	1
2		LEG PATTE	2

LISTE DES PIÈCES DE MONTAGE HARDWARE LIST

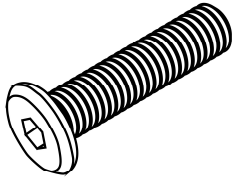
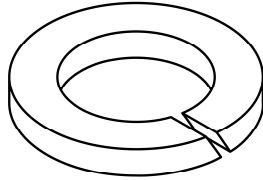
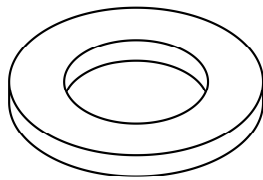
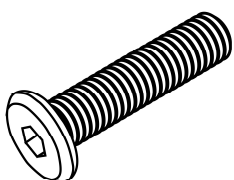
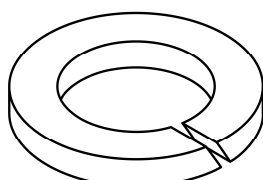
PIÈCE / PART #	IMAGE	DESCRIPTION	QTY / QTÉ
A		ASSEMBLING BOLT - Ø 3/8" X 2" BOULON D'ASSEMBLAGE - Ø 3/8" X 2"	4
B		LOCK WASHER - Ø 3/8" X 3/4" ENTRETOISE DE MÉTAL - Ø 3/8" X 3/4"	4
C		METAL WASHER - Ø 3/8" X 7/8" RONDELLE DE MÉTAL - Ø 3/8" X 7/8"	4
D		ASSEMBLING BOLT - Ø 1/4" X 2" BOULON D'ASSEMBLAGE - Ø 1/4" X 2"	4
E		LOCK WASHER - Ø 1/4" X 1/2" ENTRETOISE DE MÉTAL - Ø 1/4" X 1/2"	4

LISTE DES PIÈCES DE MONTAGE HARDWARE LIST

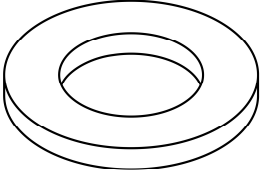
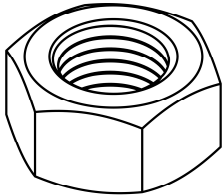
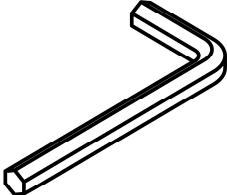
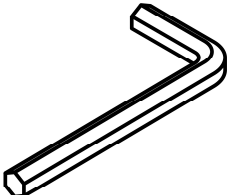
PIÈCE / PART #	IMAGE	DESCRIPTION	QTY / QTÉ
F		METAL WASHER - Ø 1/4" X 3/4" RONDELLE DE MÉTAL - Ø 1/4" X 3/4"	8
G		HEX NUT - M6 ÉCROU HEXAGONALE - M6	4
H		HEX KEY - M5 X 2 1/2" CLÉ HEXAGONALE - M5 X 2 1/2"	1
I		HEX KEY - M4 X 2 1/2" CLÉ HEXAGONALE - M4 X 2 1/2"	1

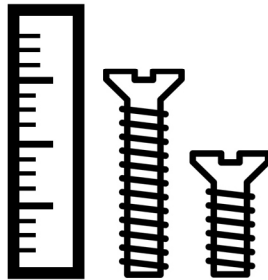

OUTIL DE VÉRIFICATION DE DIMENSIONS DES PIÈCES
HARDWARE DIMENSIONS VERIFICATION TOOL



ÉTAPE / STEP 1

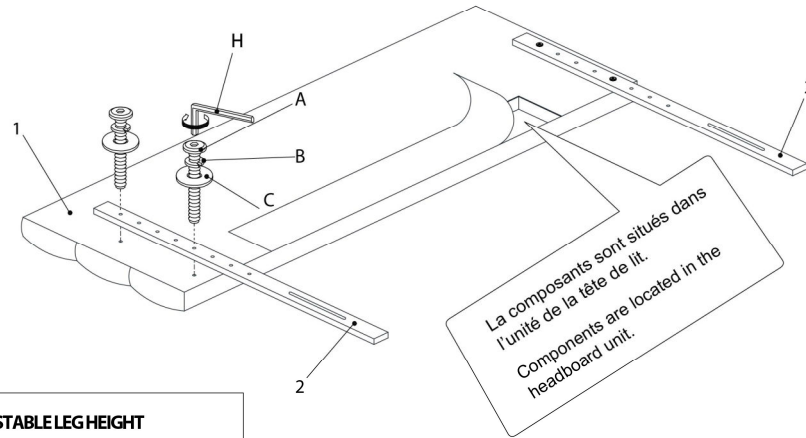

ÉTAPE / STEP 2

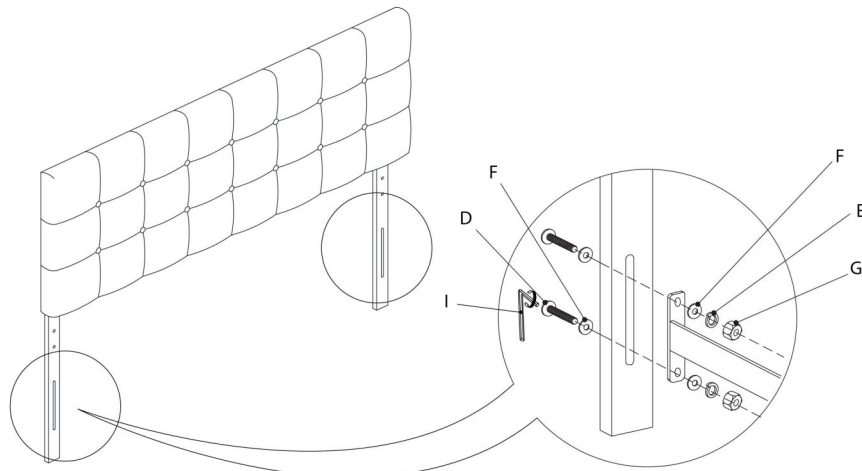

ÉTAPE / STEP 3

