

①

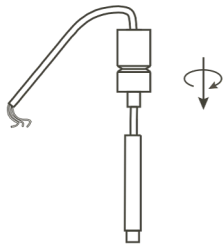

②

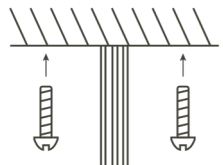

③

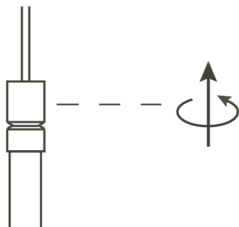

④

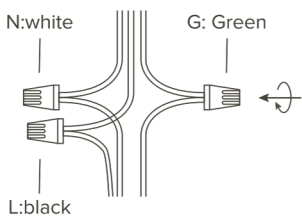

⑤

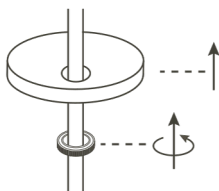

⑥

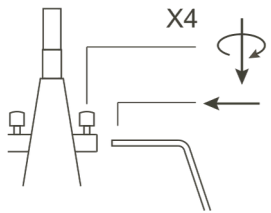

⑦



⑧

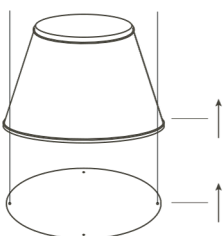

⑨

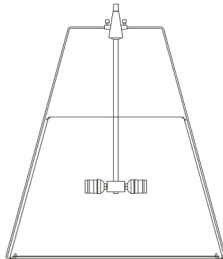
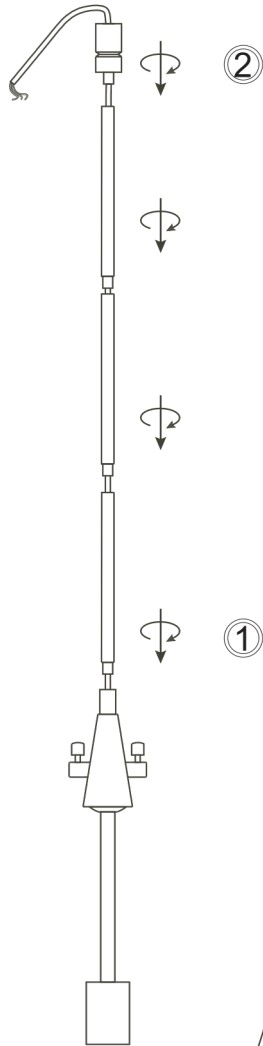

E26 LED only  
1\*Max 25W  
Not included



E26 LED only  
3\*Max 25W  
Not included

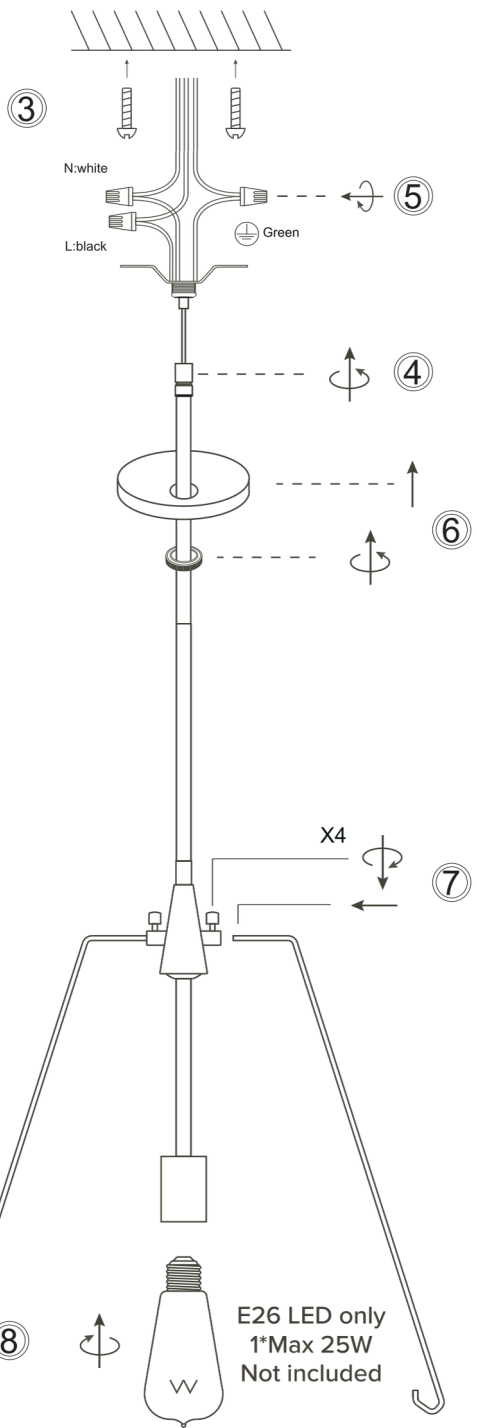

⑧

E26 LED only  
1\*Max 25W  
Not included

⑨



# Arthur Pendant Light Instruction

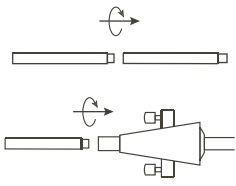

## Step 1: Set height & assemble the stem

- Place the fixture on a soft surface to protect the shade.
- Choose the combination of threaded downrods needed for your hanging height.
- Thread the rods together clockwise and into the fixture's top coupler (the cone above the shade).

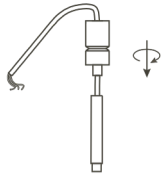

## Step 2: Attach the top coupler

- Thread the screw-collar loop / top coupler onto the top end of the assembled downrod (clockwise). Hand-tighten, then snug with a wrench—do not over-tighten.

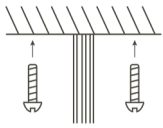

## Step 3: Install the mounting crossbar to the ceiling box

- At the ceiling, fasten the mounting crossbar to the junction box using the two box screws.

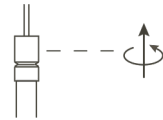

## Step 4: Tighten the shaking head upwards

- Install the shaking upwards with the canopy.

## Step 5: Make the electrical connections

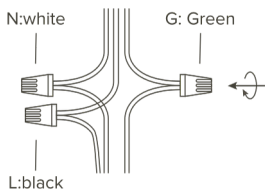

- Lift the fixture and thread the screw-collar loop onto the center post of the installed crossbar so the fixture is supported.
- Connect wires using the supplied wire nuts:
  - Fixture black (L) → house black (hot).
  - Fixture white (Neutral) → house white (neutral).
  - Fixture green/bare (Ground) → house ground and/or to the green ground screw on the crossbar.

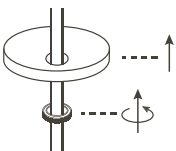

## Step 6: Lock the canopy in place

- Thread the canopy lock ring upward onto the screw-collar loop under the canopy and tighten by hand until the canopy is snug and flush to the ceiling.
- Slide the canopy upward to cover the junction box and crossbar, keeping wires clear and not pinched.

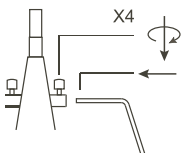

## Step 7: Assemble the shade supports

- Attach the four steel support wires to the shade holder at the top of the fixture.
- Insert each wire fully and secure with the four set screws. Make sure the wires are evenly spaced and hang straight.



## Step 8: Install the bulb

- Screw one E26 medium-base LED bulb (25 W max, not included) into the socket inside the frame. Use LED only; if the light will be dimmed, use an LED-compatible dimmer.

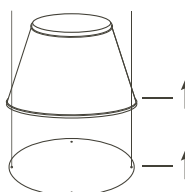

## Step 9: Finish with the diffuser

- From below, raise the diffuser into position. Remove any protective film from the diffuser.
- Align the holes on the inner ring of the diffuser with the ends of the four support wires, then insert the wires into the holes until the diffuser is seated and level.

Please contact us if you have any problems installing the lampshade. We will work you through the process.