

ASSEMBLY INSTRUCTION

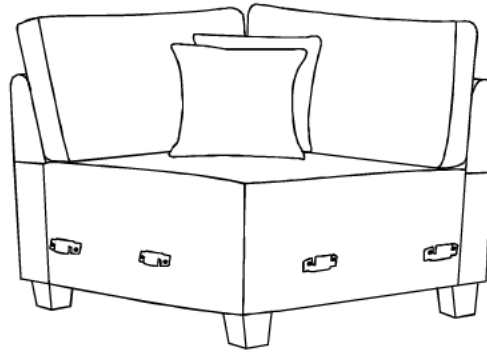

PARTS LIST

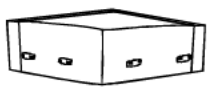

A X1

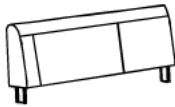

B X1

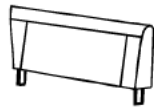

C X1



D X1



E X1



F X1

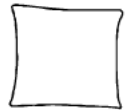

G X1

HARDWARE LIST



1 X4

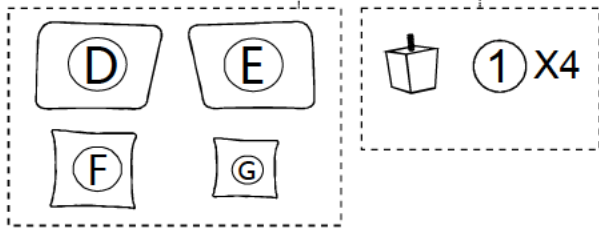
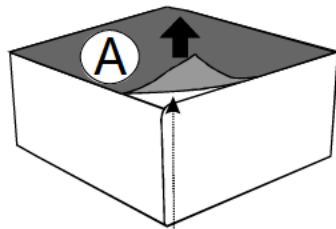

Step 1

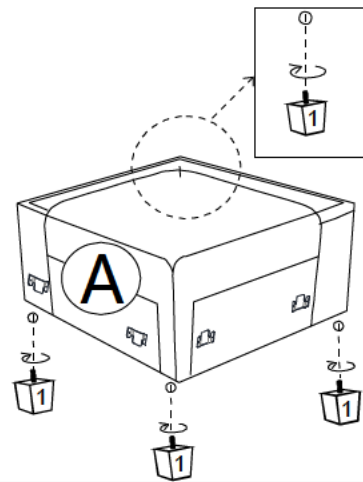

Step 2

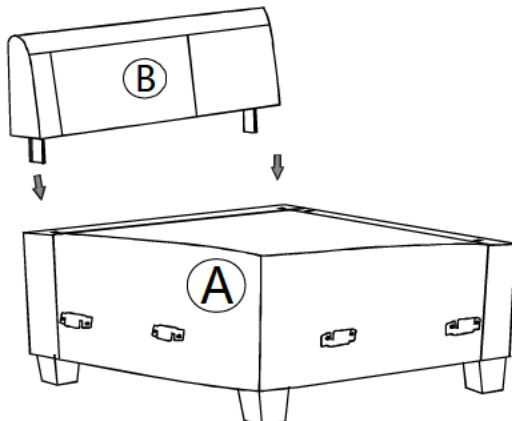

Step 3

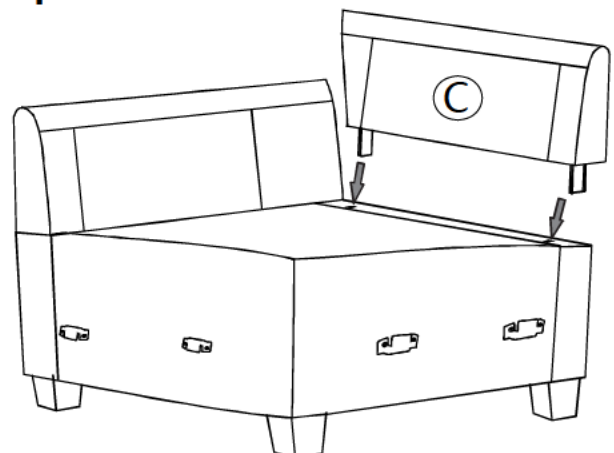

Step 4

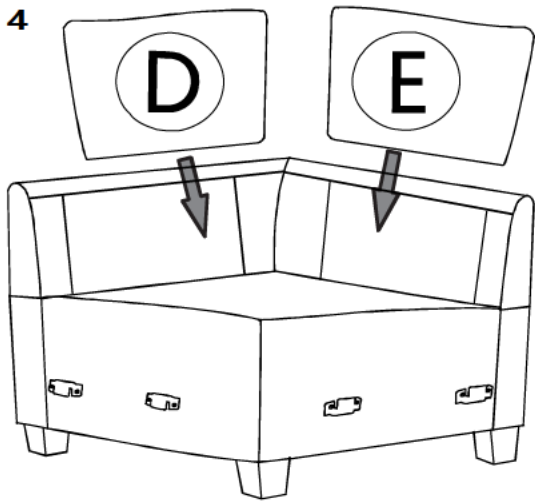

Step 5

