

Assembly Instructions

Caution : You must read this before you proceed

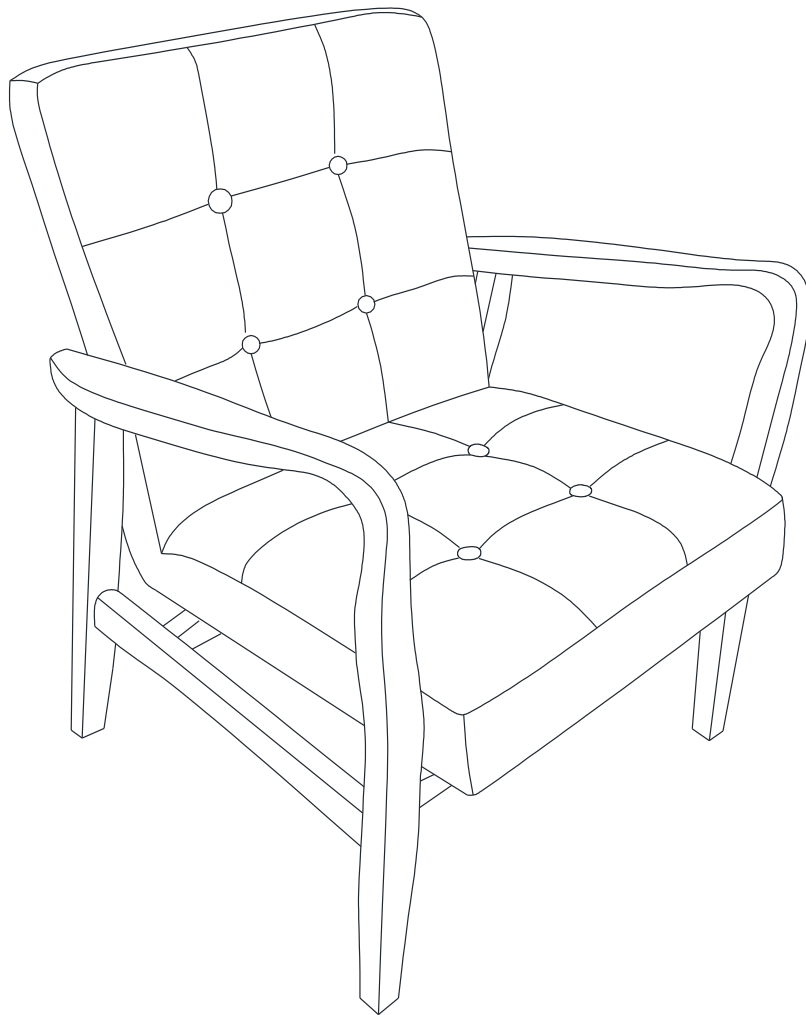

Arm Chair

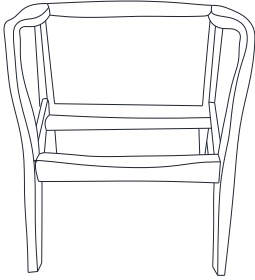
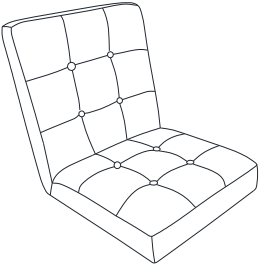

Parts List

Label	Picture	Description	QTY
A		Frame	1
B		Seat	1

Hardware

Label	Picture	Description	QTY
①		Screw (M4*50mm)	5
②		Screwdriver	1

Assembly Preparation

Before
Beginning
Assembly:

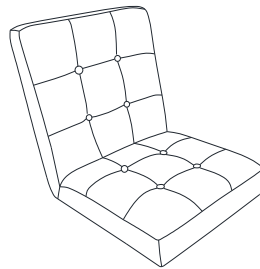
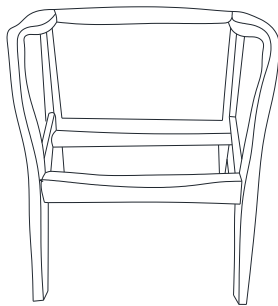

- Read instructions, cover to cover-
- Have 2 adults on hand for assembly-
- Do not assemble on flooring or carpet-
- Assemble on a clean non-marring surface (packing foam)-
- Save all packaging until finished-

Assembly Steps

Overview

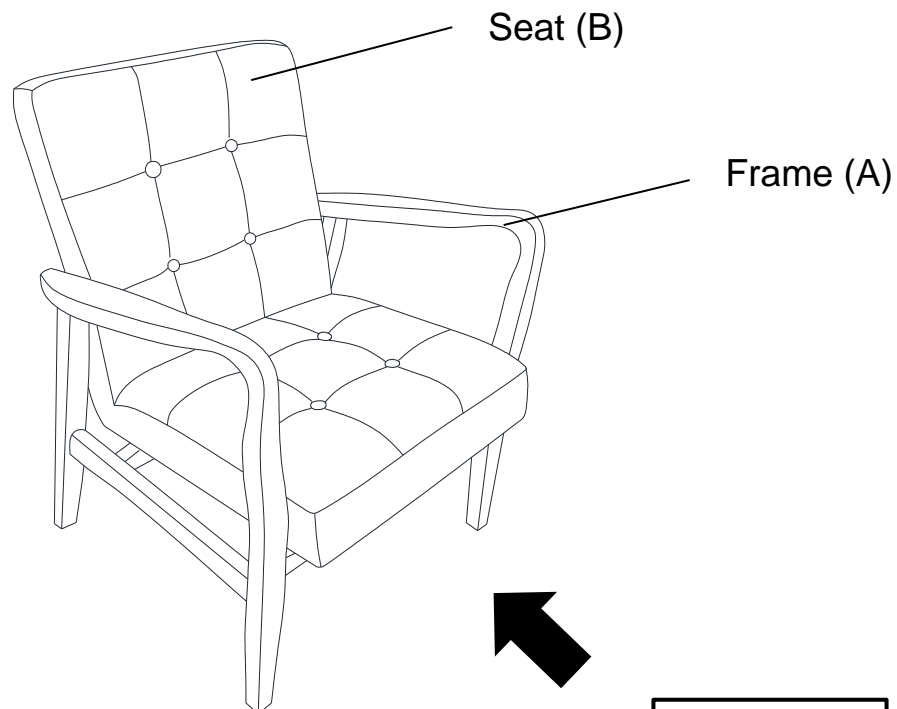

Front Facing

This Armchair has multiple parts and may require up to 30 minutes to assemble. To give you an overview of the Armchair parts, the above picture is to help you put the various parts into perspective. Please read through the instructions below to familiarise yourself with the parts and steps before assembly.

Step 1

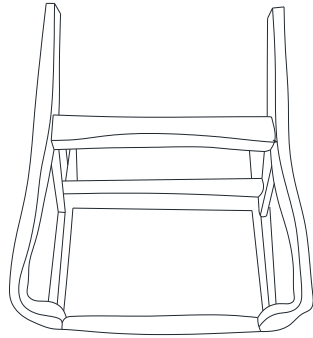

Frame(A)

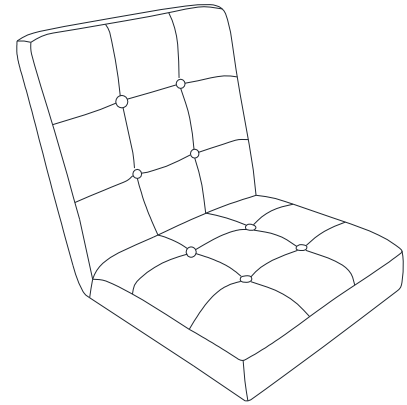

Seat(B)

Place the Frame(A) and Seat(B) on a clean, non-marring surface. Place the Frame(A) with the Legs facing skywards.

Step 2

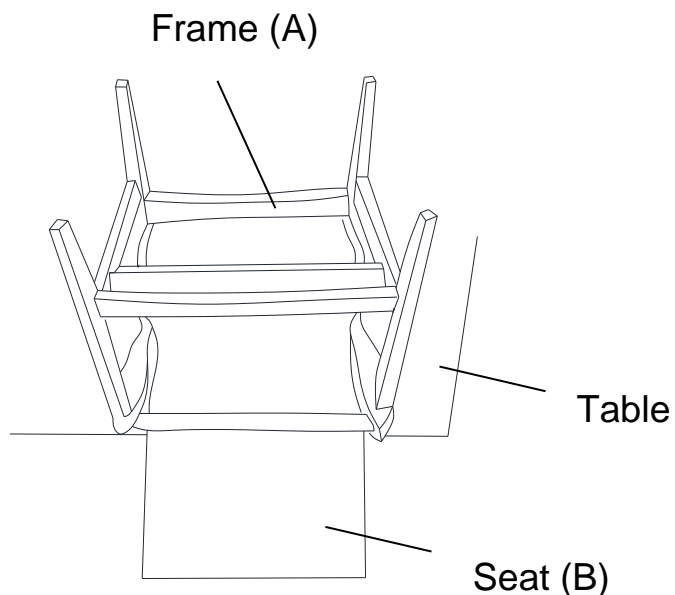

Step 2.1

Seat(B) stuck in the middle of the Frame(A)

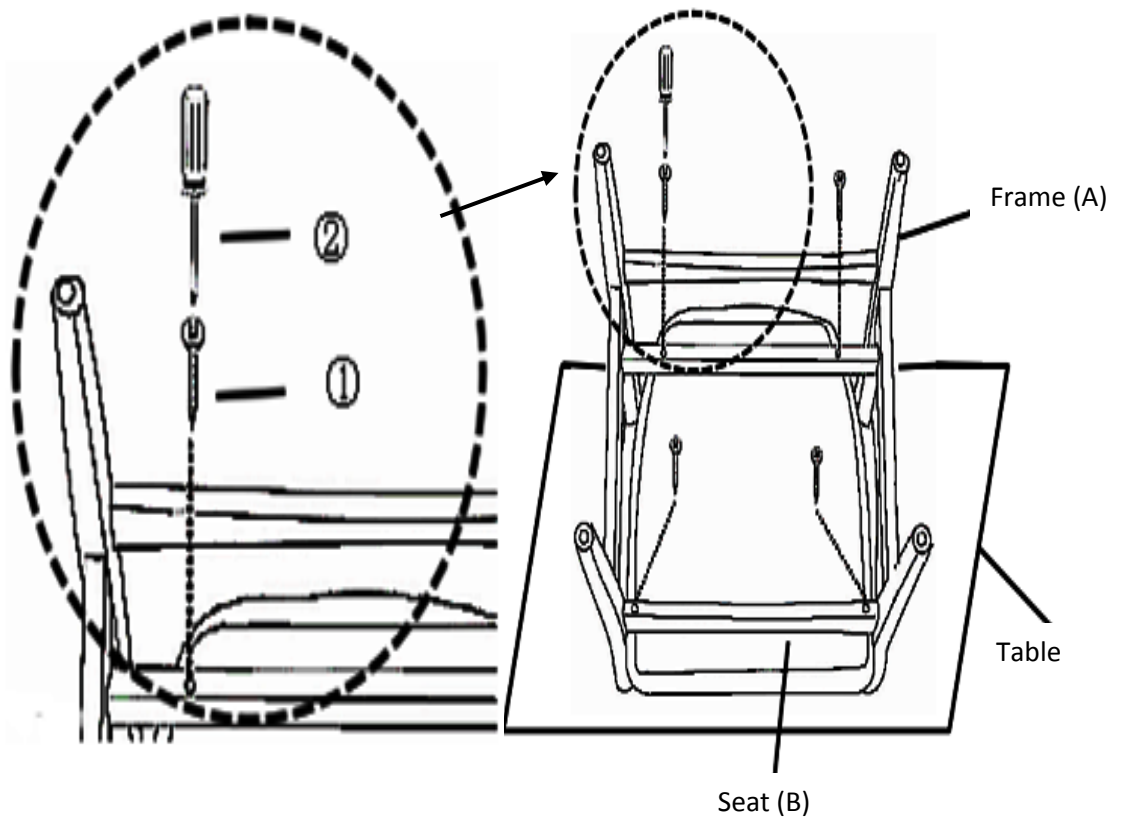

Step 2.2

Place the Seat(B) on the side of a table, with the backrest facing down and perpendicular to the Desk Top.

2.1) Place the Frame(A) onto the Seat(B) with the Seat(B) stuck in the middle of the Frame(A) and align the mounting positions.

2.2) Attach Frame(A) to Seat(B) using Screws(①) with Screwdriver(②).
Do not fully tighten the Screws.

Note: If there are gaps between the Frame(A) and Seat(B) which hinder installation, pull the Seat(B) upwards into the Frame(A).

Step 3

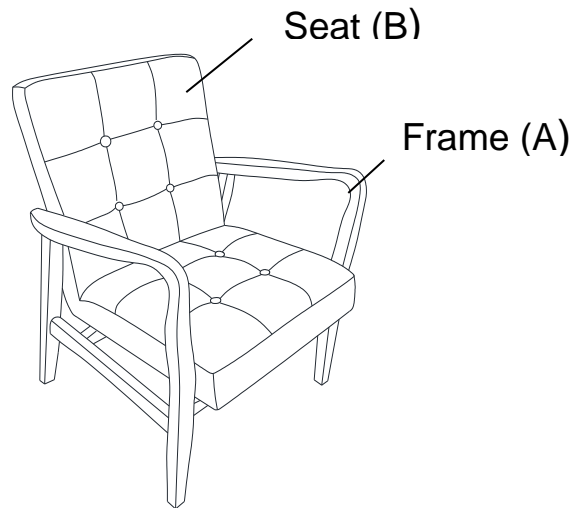

Test for Stability





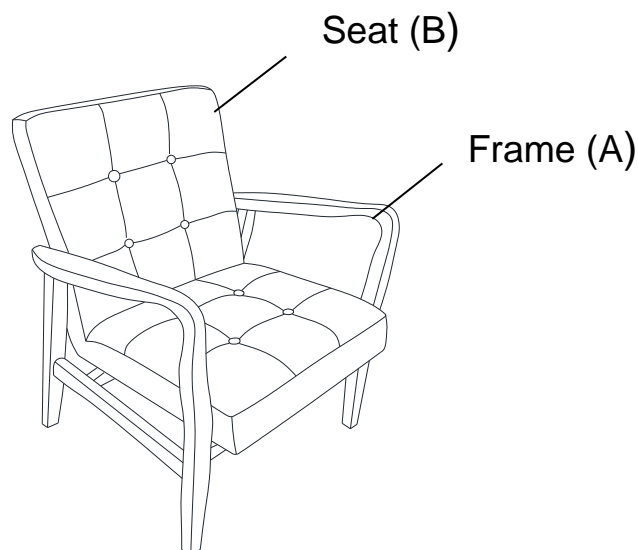















Finally, stand the Armchair up, and place it on a **LEVEL SURFACE**. Inspect it and make sure all parts are adequately connected. Gently and carefully, sit into to the Armchair. This would help to align all the parts at all joints. Then get off the Armchair, and place it facedown. Proceed to tighten all Screws in a sequential manner. If there are still wobbles, loosen the Screws and execute this same process.

Step 4



Your Armchair is ready for use.
This Armchair can only be used on a flat, level surface.

Care & Maintenance

-   ● Do not put hot items directly on furniture surface.
 -   ● Do not clean furniture with harsh cleansers or polish.
 -   ● Do not place furniture under direct sunlight.
 -   ● Do not place furniture near heating or cooling vents.
 -   ● Do not write on furniture without a padded barrier to protect the surface.
 -   ● Do not place furniture outside . For indoor use only .
 -   ● Not for commercial use. For residential use only .
 -   ● Stains may be removed with mild soap solution and damp cloth.
 -   ● Children should not climb or jump on the furniture.
-
-   ● Dust and pick-up spills using a clean, non-colored, lint-free cloth .

What is Proposition 65?

Proposition 65 is a California law that requires warning labels on products that may contain one of more than 800-plus chemicals or ingredients that the California Office of Environmental Health Hazard Assessment (OEHHA) has deemed to cause cancer or other reproductive toxicity. Chemicals and elements on this list include wood dust, brass, and other everyday substances, which can be found in very common household items, such as: lamps, tableware, jewelry, crystal glasses, electric cords, beauty products, automobiles, and furniture.

Why Did I Find a Proposition 65 Warning on My Home Goods Product?

We include Proposition 65 warnings on all of our products because there is always a chance that one of the 800-plus common chemicals and ingredients listed under this law could potentially be on our furniture or packing materials. We risk large fines under this law, if we don't include this warning.

Should I worry?

We realize you may be worried finding this warning on our products, but we want to reassure you that the hazardous exposure limits for any of these chemicals have never been found on furniture products that we've shipped to our customers. Additionally, this warning label is very common and can be found on almost every piece of furniture sold in the state of California.

Just How Common Are Proposition 65 Warnings?

Proposition 65 warnings have become so common in California that it is hard to take a trip to a local bank, grocery store, or restaurant without finding at least one warning. In fact, even the Disney Land Resort has a Proposition 65 warning:

