

# User's Manual

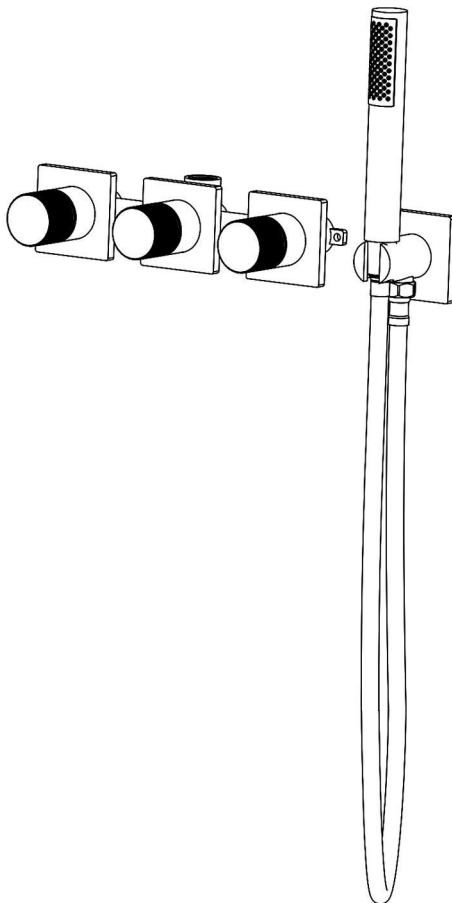

# INSTALLATION INSTRUCTIONS

## Installation Manual

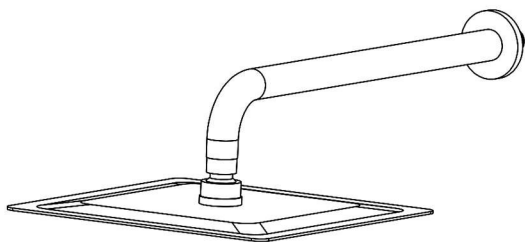

### IAPMO RESEARCH AND TESTING, INC.

5001 East Philadelphia Street, Ontario, California 91761-2816 • USA • 909-472-4100 • 909-472-4244 • www.iapmort.org



### CERTIFICATE OF LISTING

IAPMO Research and Testing, Inc. is a product certification body which tests and inspects samples taken from the supplier's stock or from the market or a combination of both to verify compliance to the requirements of applicable codes and standards. This activity is coupled with periodic surveillance of the manufacturer's production process, including an annual factory audit, to ensure the approval of the Product Certification Committee, or any successor organization, and to ensure that the manufacturer's production process continues to conform to the requirements of the listing. This listing is subject to the conditions set forth in the characteristics below and is not to be construed as any representation, assurance or guarantee by IAPMO Research and Testing, Inc. or the product manufacturer by Authorities Having Jurisdiction.

This certificate is not evidence of current listing. To verify listing status, visit the IAPMO R&T Product Listing Directory at [pld.iapmo.org](http://pld.iapmo.org)

Effective Date: December 2019 -Rev. 2/24/2020- Void After: December 2024

Product: Flexible Water Connectors File No. 5111

Issued To:  
Fanak Group Inc.  
Mechanical & Electrical  
Industrial Zone,  
Yuhuan County,  
Yuhuan 317600, ZHEJIANG  
China

Identification: Products shall be marked with manufacturer's name or trademark, a statement "For use with water in accessible locations only." The products shall also bear the cUPC® certification mark. Markings shall be by means of either a permanent mark on the product, a label on the product or a tag attached to the product.

Characteristics: Flexible water connectors manufactured in various sizes, lengths and metal and fittings for hot or cold water applications that consist of an inner tube, which may or may not have an outer braided cover. Connectors are to be installed for use in accessible locations only. To be installed in accordance with the manufacturer's instruction, and the latest edition of the Uniform Plumbing Code and National Plumbing Code of Canada.

Products listed on this certificate have been tested by an IAPMO R&T recognized laboratory. This recognition has been granted based upon the

*Tom Collins*  
Chairman, Product Certification Committee

*Ran Chong*  
CEO, The IAPMO Group



This listing is based upon the test data of the month indicated on the Effective Date and Void After Date shown above. Any change in material, manufacturing process, marking or design without written prior consent of the Product Certification Committee, or any successor organization, and to ensure that the manufacturer's production process continues to conform to the requirements of the listing. Production of or reference to this form for advertising purposes may be made only by specific, written permission of IAPMO Research and Testing, Inc. Any alteration of this certificate could be grounds for revocation of the listing. This document shall be reproduced in its entirety.

### IAPMO RESEARCH AND TESTING, INC.

5001 East Philadelphia Street, Ontario, California 91761-2816 • USA • 909-472-4100 • 909-472-4244 • www.iapmort.org



### CERTIFICATE OF LISTING

IAPMO Research and Testing, Inc. is a product certification body which tests and inspects samples taken from the supplier's stock or from the market or a combination of both to verify compliance to the requirements of applicable codes and standards. This activity is coupled with periodic surveillance of the manufacturer's production process, including an annual factory audit, to ensure the approval of the Product Certification Committee, or any successor organization, and to ensure that the manufacturer's production process continues to conform to the requirements of the listing. This listing is subject to the conditions set forth in the characteristics below and is not to be construed as any representation, assurance or guarantee by IAPMO Research and Testing, Inc. or the product manufacturer by Authorities Having Jurisdiction.

This certificate is not evidence of current listing. To verify listing status, visit the IAPMO R&T Product Listing Directory at [pld.iapmo.org](http://pld.iapmo.org)

Effective Date: November 2019 Void After: November 2024

Product: Plumbing Fixture Fittings File No. 10613

Issued To:  
Aqua Gallery Co., Ltd  
118-118A Ailo Block  
International Dynamics  
Sanitary City, 528000  
Foshan,  
China

Identification: Plumbing supply fittings complying with this Standard shall be marked with the manufacturer's recognized name, trademark, or other mark or, in the case of private labeling, the name, trademark or other mark of the customer for whom the fitting was manufactured. The marking shall be accomplished by use of a permanent mark or by placing a permanent label on the product. Markings on plumbing supply fittings shall be visible after installation.

Single-handle, single-control, and automatic compensating mixing bath and shower valves shall have identifiable temperature control settings in which the settings are indicated by words ("cold", "warm", "hot", etc.), by numbers, or graphically.

Package shall be marked with the manufacturer's name, trademark, or other mark as well as the model number or, in the case of private

*Tom Collins*  
Chairman, Product Certification Committee

*Ran Chong*  
CEO, The IAPMO Group



This listing is based upon the test data of the month indicated on the Effective Date and Void After Date shown above. Any change in material, manufacturing process, marking or design without written prior consent of the Product Certification Committee, or any successor organization, and to ensure that the manufacturer's production process continues to conform to the requirements of the listing. Production of or reference to this form for advertising purposes may be made only by specific, written permission of IAPMO Research and Testing, Inc. Any alteration of this certificate could be grounds for revocation of the listing. This document shall be reproduced in its entirety.

### IAPMO RESEARCH AND TESTING, INC.

5001 East Philadelphia Street, Ontario, California 91761-2816 • USA • 909-472-4100 • 909-472-4244 • www.iapmort.org



### COMPONENT



### CERTIFICATE OF LISTING

IAPMO Research and Testing, Inc. is a product certification body which tests and inspects samples taken from the supplier's stock or from the market or a combination of both to verify compliance to the requirements of applicable codes and standards. This activity is coupled with periodic surveillance of the manufacturer's production process, including an annual factory audit, to ensure the approval of the Product Certification Committee, or any successor organization, and to ensure that the manufacturer's production process continues to conform to the requirements of the listing. This listing is subject to the conditions set forth in the characteristics below and is not to be construed as any representation, assurance or guarantee by IAPMO Research and Testing, Inc. or the product manufacturer by Authorities Having Jurisdiction.

This certificate is not evidence of current listing. To verify listing status, visit the IAPMO R&T Product Listing Directory at [pld.iapmo.org](http://pld.iapmo.org)

Effective Date: March 2019 Void After: March 2024

Product: Plumbing Fixture Fittings - Components File No. MC-9703

Issued To:  
Ningbo Nandai Cartridge Technology Co., Ltd.  
Liaohu Zone, Chunmou  
Fenghua 311030  
China

Identification: Each fitting component shall bear permanent legible markings to identify the manufacturer. This marking shall be the trade name, trademark, or other mark known to identify the manufacturer. The product shall also bear all other markings required by the standards. The marking shall be applied so as to be visible after installation. The product or packaging shall also bear the cUPC® certification mark along with the term "COMPONENT" above.

Characteristics: Plumbing fixture fitting components to be installed in accordance with the manufacturer's instructions and the requirements of the latest edition of the Uniform Plumbing Code.

Products listed on this certificate have been tested by an IAPMO R&T recognized laboratory. This recognition has been granted based upon the Laboratory's compliance to the applicable requirements of ISO/IEC 17025.

Products are in compliance with the following code(s):  
Uniform Plumbing Code (UPC®)

*Tom Collins*  
Chairman, Product Certification Committee

*Ran Chong*  
CEO, The IAPMO Group



This listing is based upon the test data of the month indicated on the Effective Date and Void After Date shown above. Any change in material, manufacturing process, marking or design without written prior consent of the Product Certification Committee, or any successor organization, and to ensure that the manufacturer's production process continues to conform to the requirements of the listing. Production of or reference to this form for advertising purposes may be made only by specific, written permission of IAPMO Research and Testing, Inc. Any alteration of this certificate could be grounds for revocation of the listing. This document shall be reproduced in its entirety.

# BEFORE INSTALLATION

NO.	Items	Qty
1	Shower arm	1
2	Rain shower head	1
3	Hand shower	1
4	Hand shower bracket	1
5	Main body	1
6	Shower bracket cover plate	1
7	Shower hose	1
8	handle cover plate	3
9	Valve sleeve	3
10	Handle	3
11	Accessory bag	1

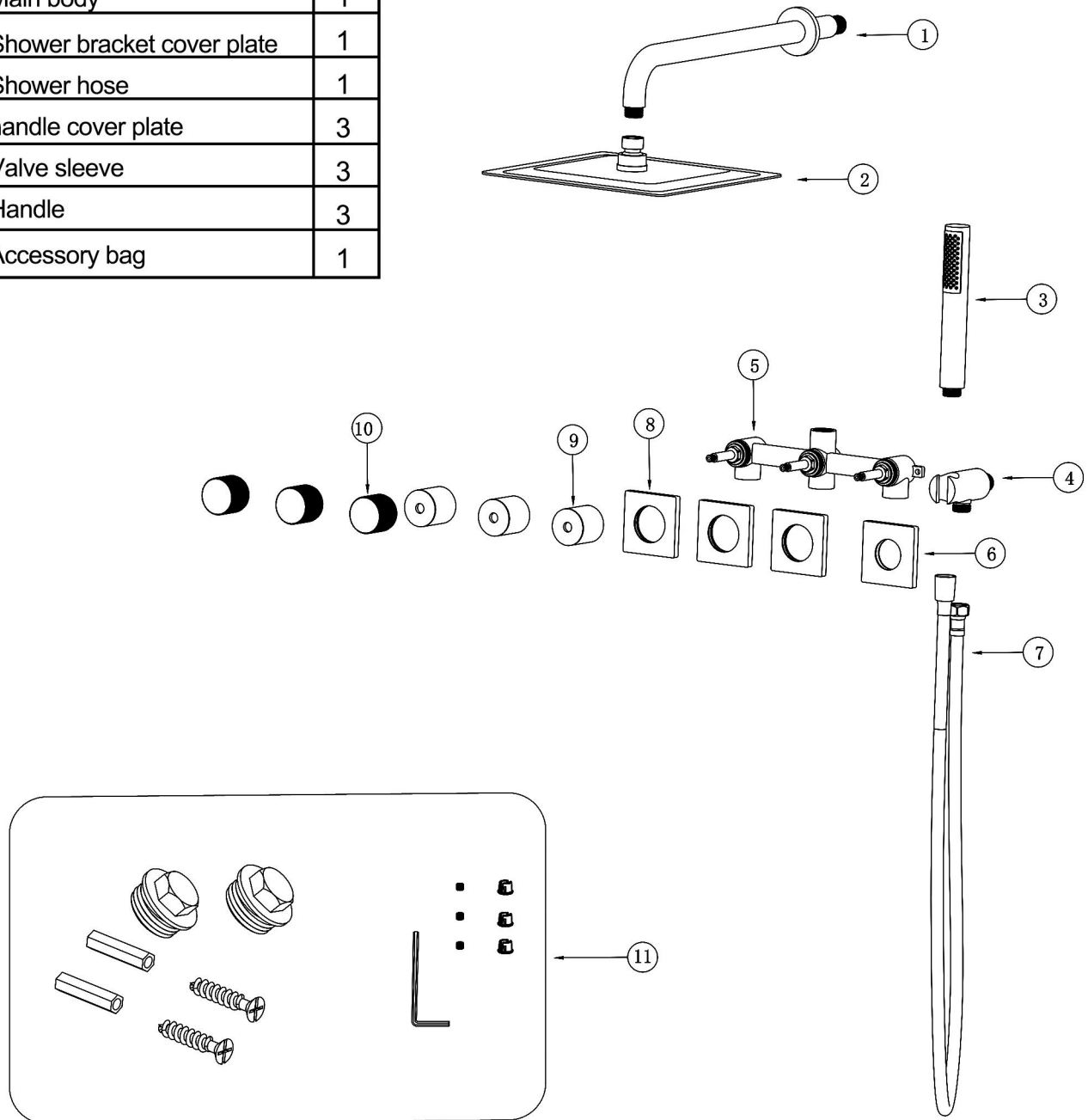

## Check accessories

### Standard List of Accessories:

When you open the product packaging, please check whether the objects in it are consistent with the main body and accessories you purchased. If there is any inconsistency, please contact our company or our distributor.

Note: 1. Accessories are subject to change without prior notice if the change does not affect usage;

2. The appearance of the product is subject to the physical objects you receive, and the schematic diagram is only for reference.

# INSTALLATION STEPS

This product has been inspected and debugged by the factory to the best condition. Please do not disassemble and assemble it yourself.

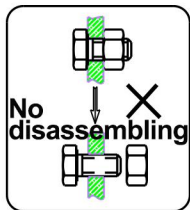

Before installing the product, please be sure to remove sundries and sludge from the water pipe to prevent sundries from blocking the product.

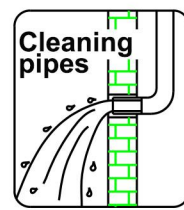

1. Dig pipe grooves for pre-burying pipes.

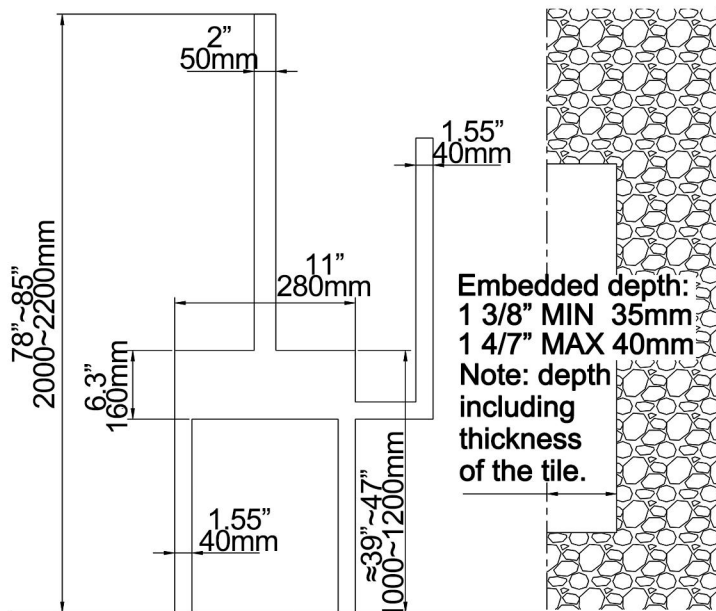

2. Install the main body, water inlet and outlet pipes.

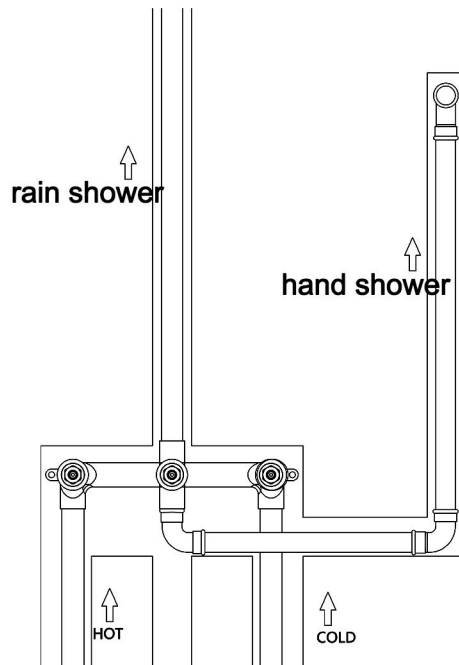

3. Fix the main body with self-tapping screws (the main body must be parallel to the wall).

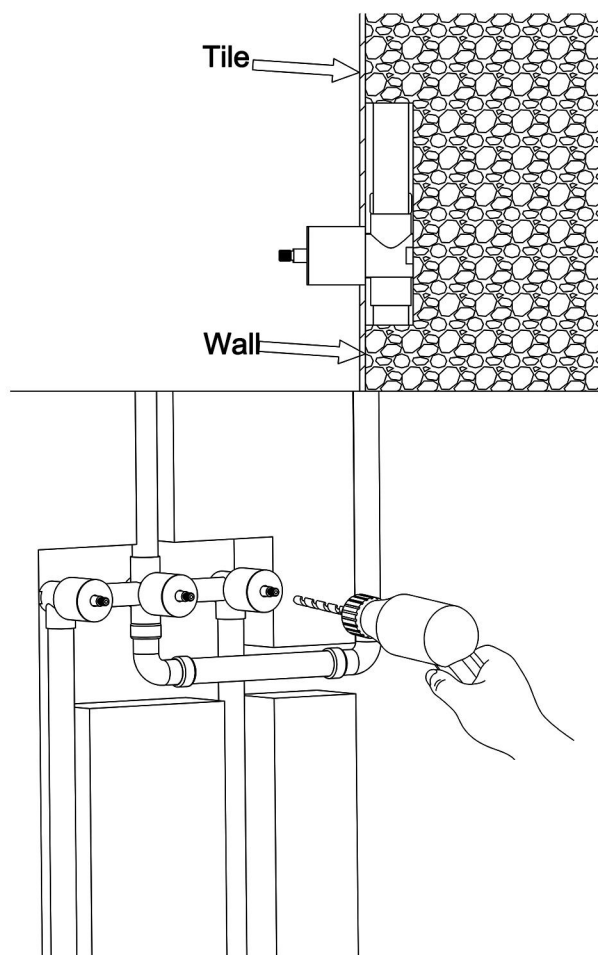

4. Keep the inlet pipe thread flushed with (or slightly below) the tile surface.

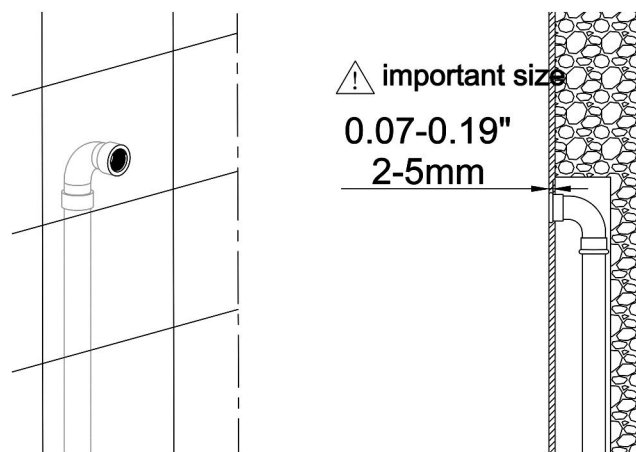

5. Install shower arm and hand shower bracket. (wrap the PTFE tape on the thread)

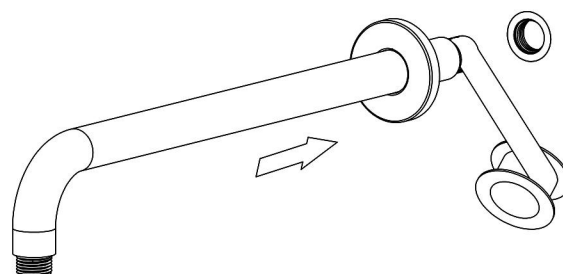

# INSTALLATION STEPS

6. Install the rain shower and hand shower.

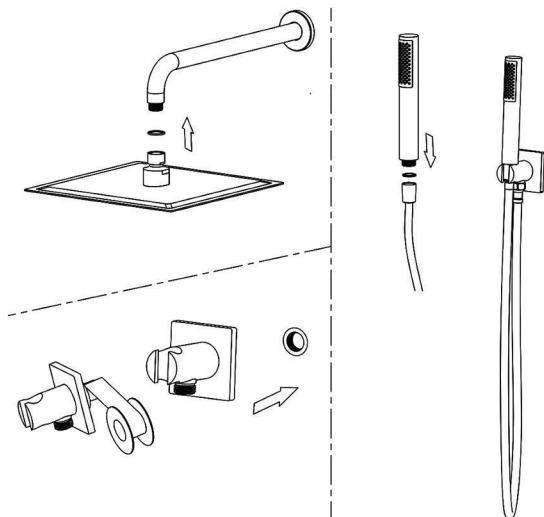

7. Install the panel and handle.

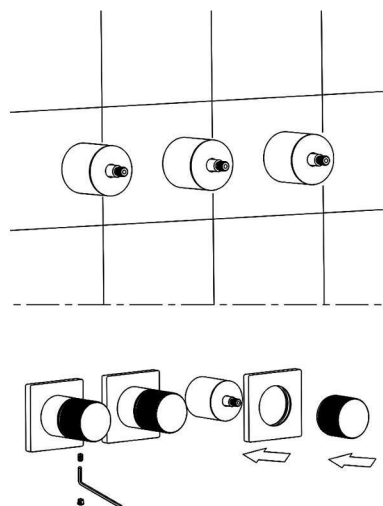

## INSTALLATION DIMENSION

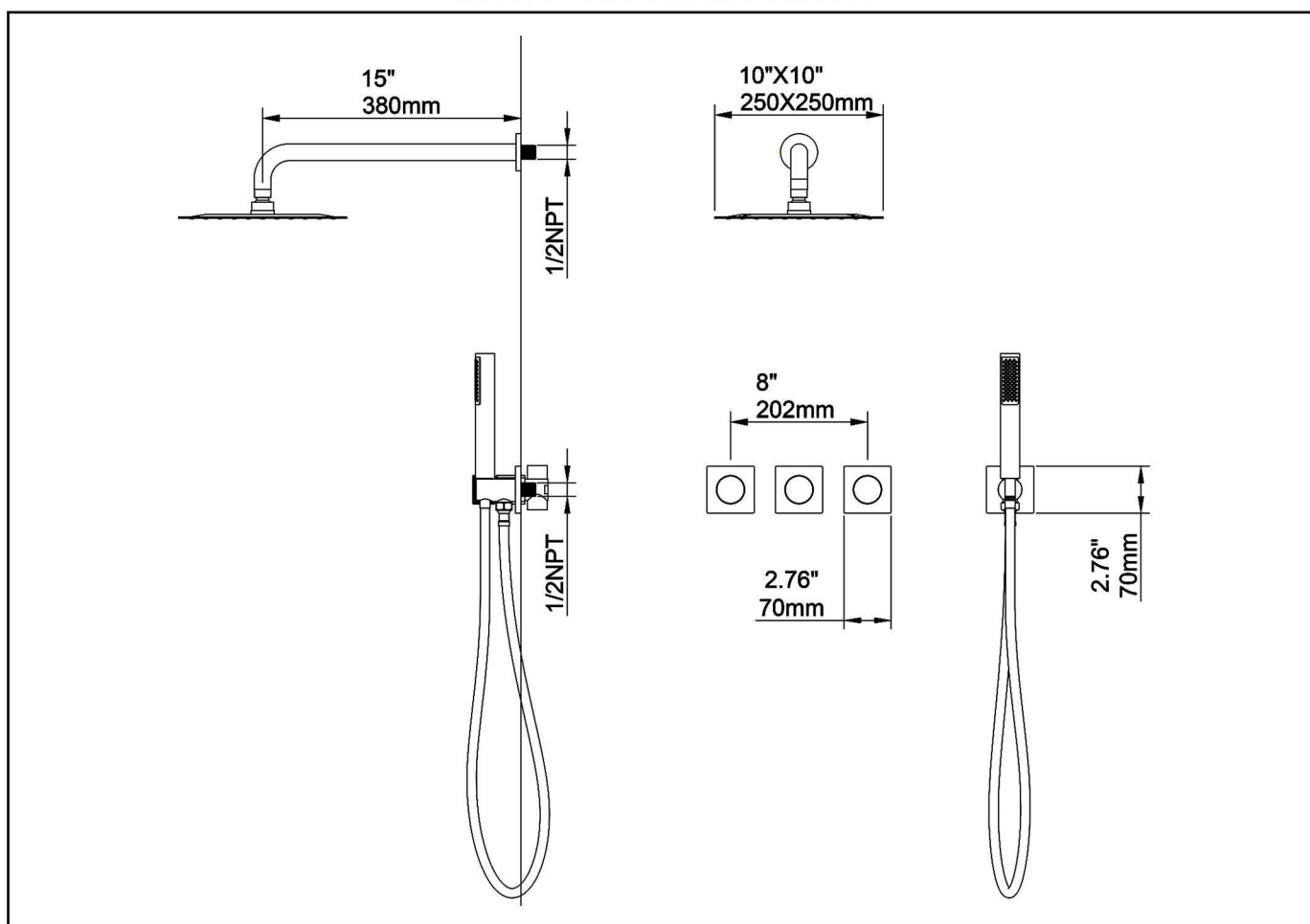

## CLEANING CARE

In order to keep the appearance of product clean, bright and good performance, please take care of the product as follows;

1. Rinse with water only and dry with soft cotton cloth;
2. Use mild liquid and colorless glass cleaner to remove surface dirt and scale film, or use polish without abrasive effect;
3. Do not use abrasive detergent, polish, emery cloth, paper towel or scraper, etc;
4. Do not use acid cleaner, or cleaner and soap with insoluble gran etc;
5. In the process of use, mud may accumulate in the bubbler and make the water flow show, The bubbler can be unscrewed, rinsed with water, and then installed back in place.



