

BL0222-10BG
 圆形花洒说明书 (尺寸A4: 210x297mm)
 正背面打印 / 单色K.

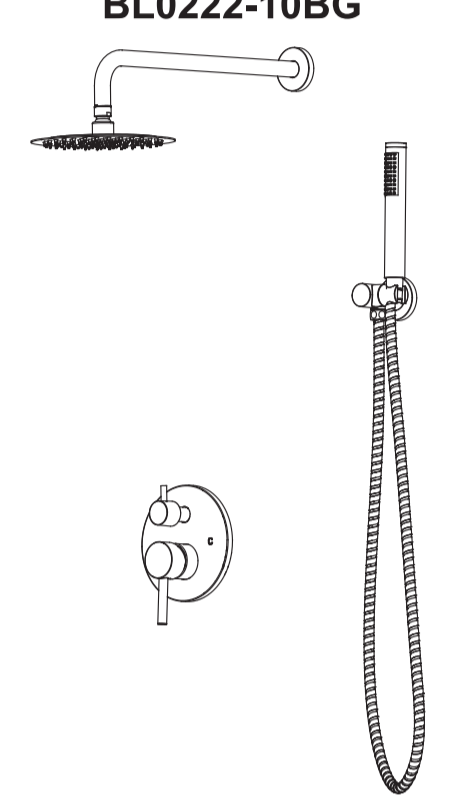

正面



Installation Instruction
BL0222-10BG

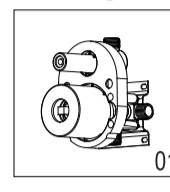
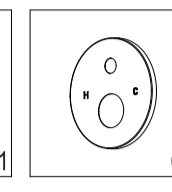
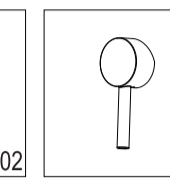
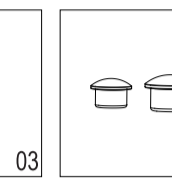
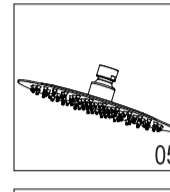
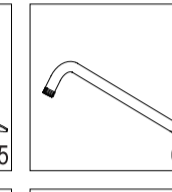
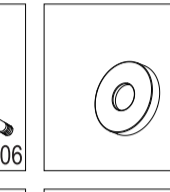
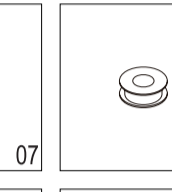
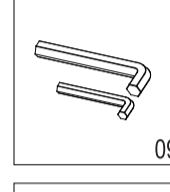
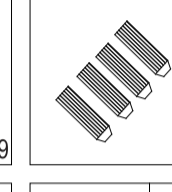
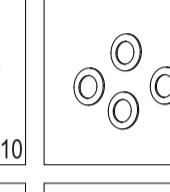
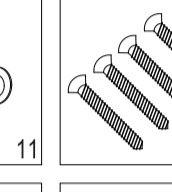
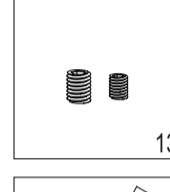
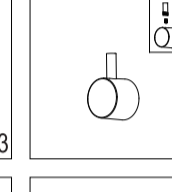
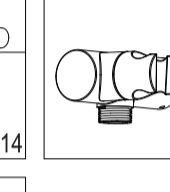
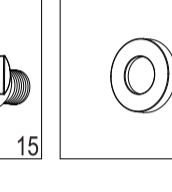

Package list of Two Functions shower

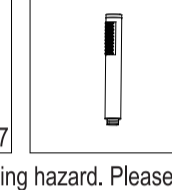

WARNING: Choking hazard. Please keep all small parts and plastic bags out of the reach of children.
 Plumbers with license install this shower system only.

Step 1: The depth is for reference only
 Design water pipe sict Recommend using copper drop ear pipe elbow(1/2"-14NPT)

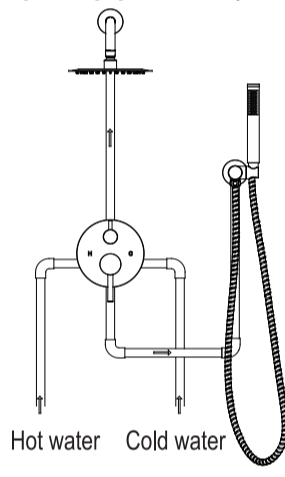

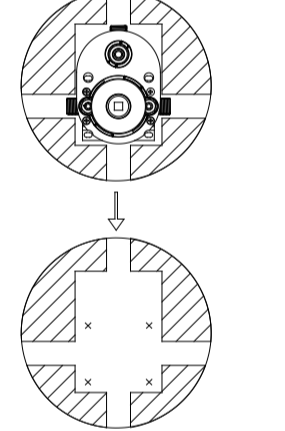

Hot water Cold water



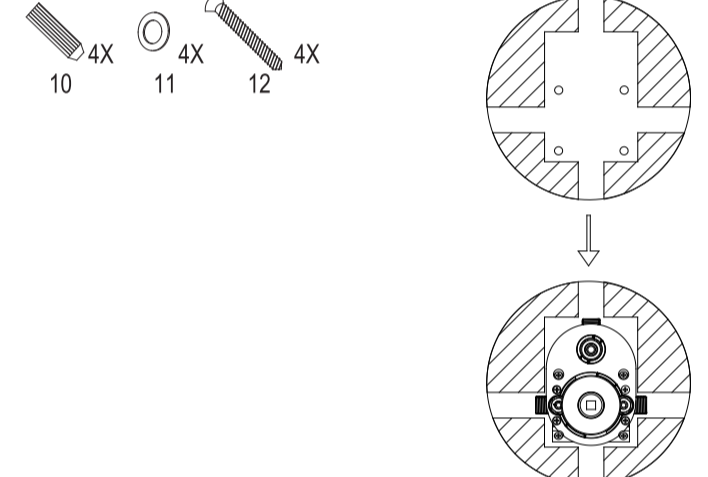

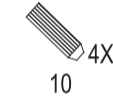
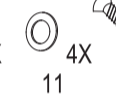
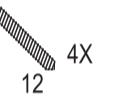
Step 2: Clean the insides of all water pipes and fittings of dirt and other impurities.
 (Be suitable for Pex pipe, Copper pipe and PVC pipe). Check for leakage and/or blockage on both hot and cold water supplies. (Shower valve must be connected with hot and cold water pipe. If only connect one, there is no water comes out)



 4X  4X  4X

 1X

 Pull forward  Rotating R or L controls temp 

背面

Step 3: Tiles (If you tile too thick, there is no enough space to install plate and handle).

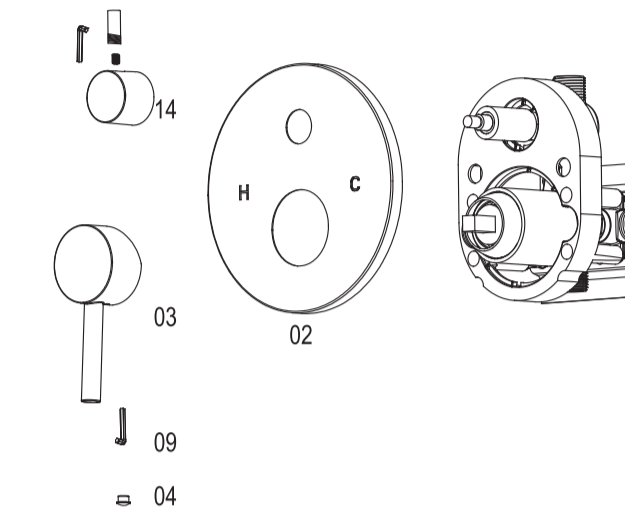

Step 5: Install Shower bracket (if have).
Install hand-held shower and hose (if have).

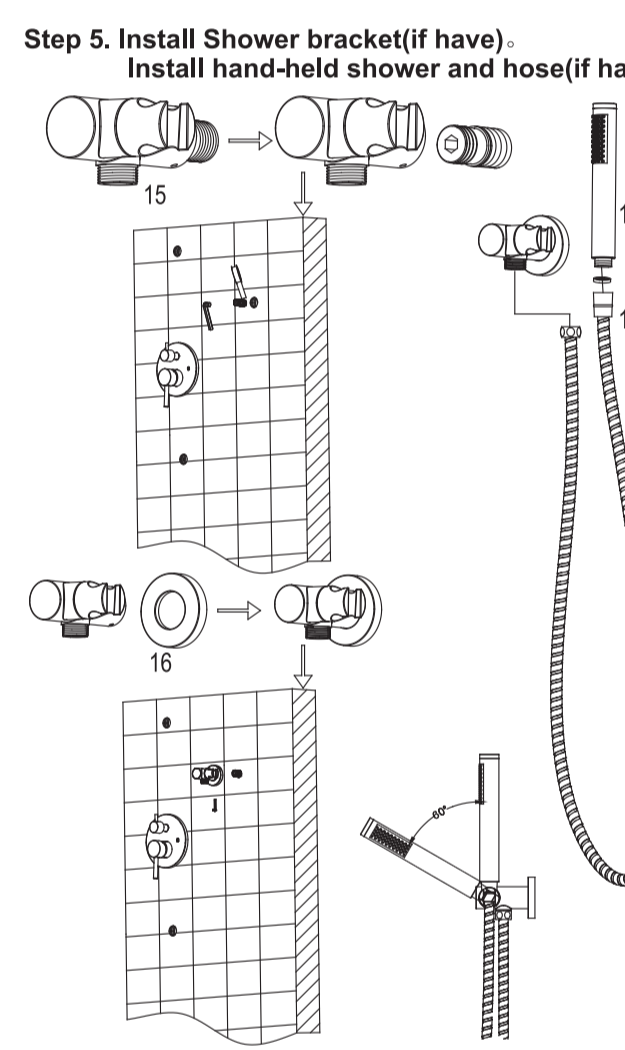

Step 4: Install Shower Arm and Rain Shower Head

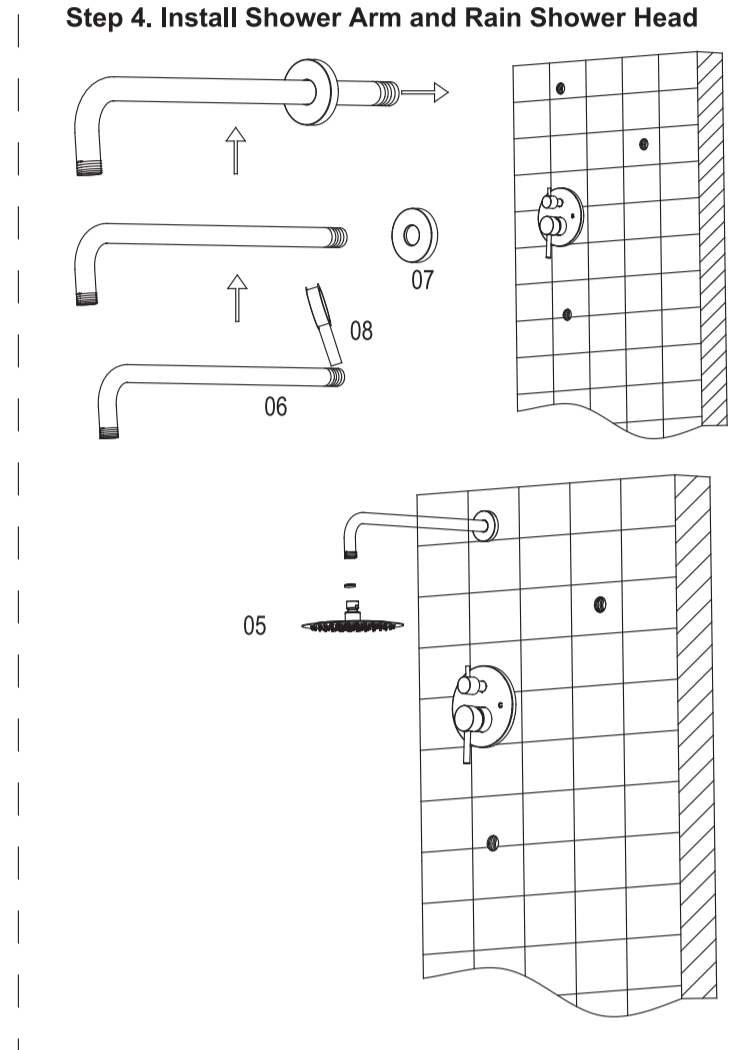

CAUTION !!!

- Water lines must be completely flushed before use, to avoid debris clogs in your water system leading to reduction of water flow and mal-functioning.
- Warranty is void if water lines are not flushed prior to use and installation of the new faucet.
- Use of abrasives of any strength may damage the finish of the faucet and void the product warranty.
- Do not over tighten your faucet on the countertop during installation. The valve assembly is tested to meet the standards set by ASME A112.18.1 sec 5.8 which is listed at 100 LBF. However, over-tightened or over-torqued nuts may lead to cracks on the valve and will eventually lead to leaking and water damage.
- Before installation of the faucet to the desired fixture, you need to secure and anchor your console, sink, tub, or vanity cabinet firmly to the wall and to the floor. To ensure your fixture or faucet mounting surface cannot be moved, before installation of the faucet please test to see if the cabinet or vanity can be moved by hand or body weight. If the faucet mounting fixture is not secure and anchored, it will eventually crack the valve and cause leaking leading to property damage. In order to avoid this, be sure to secure your installation surface. Do not use any Power Tools for assembly and installation which can cause internal fractures to the fixture.

Service Contact:

☎ 323-982-8955
 ✉ service@boyelliving.com
 🌐 www.boyelliving.com