

ASSEMBLY INSTRUCTIONS

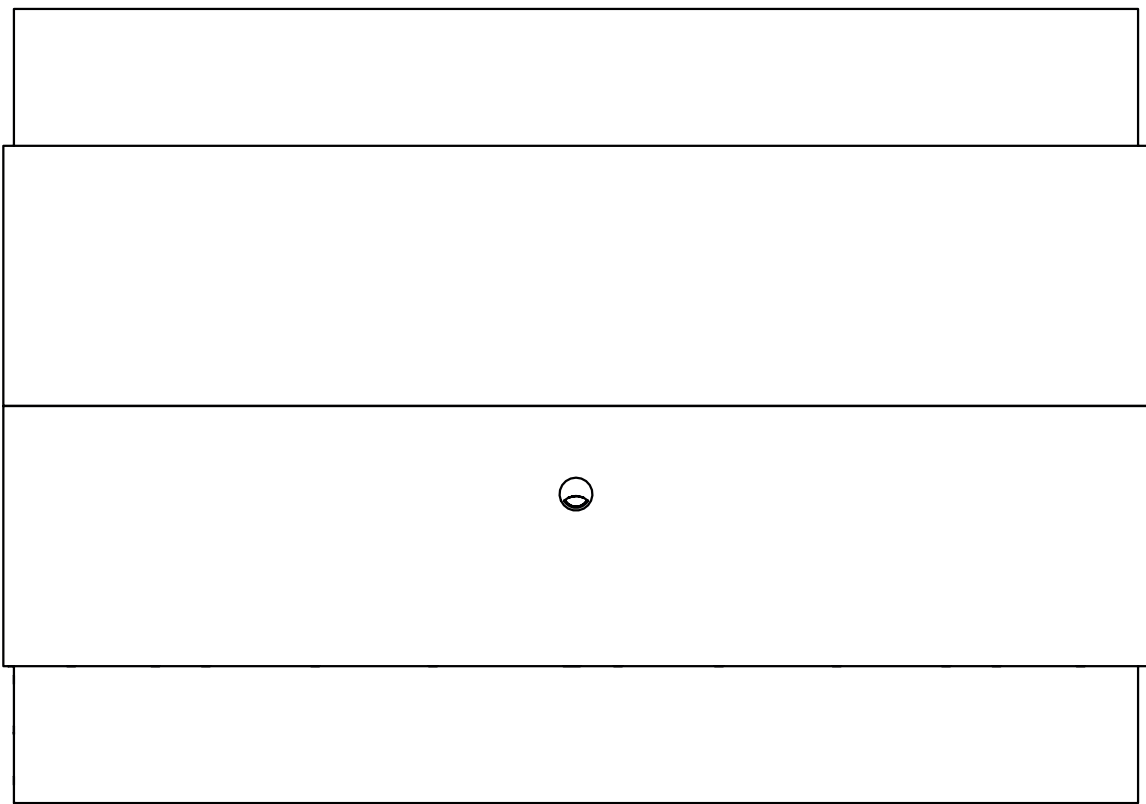

IMPORTANT REMARKS



Never climb or lean on the furniture.
You may suffer serious accidents.

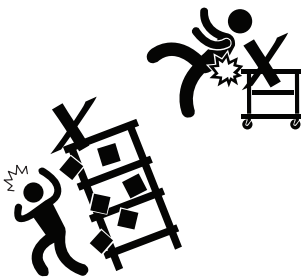

Use the packaging to cover the
assembly area and separate
all parts.

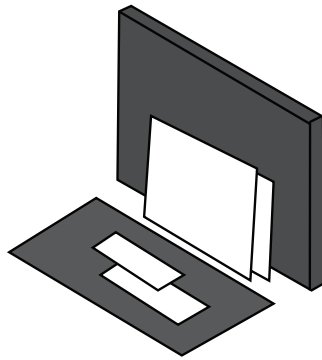

Identify the parts by observing the
number printed on their edges.

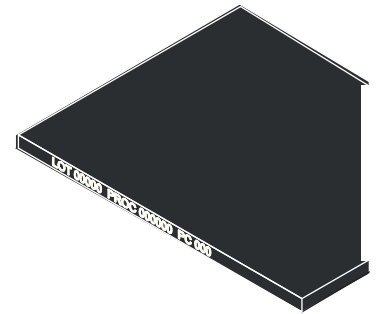

CARE INSTRUCTIONS



Wipe clean using a damp cloth and a mild cleaner.
Do not use abrasive and chemical products.



HANDLING

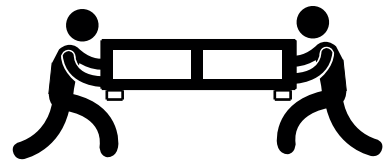

Move the piece carefully, don't drag it. Ask
for someone else's help to do so.

HARDWARE



Identify and separate the hardware used in the assembly. There's a label on each package identifying the parts and where to use them.

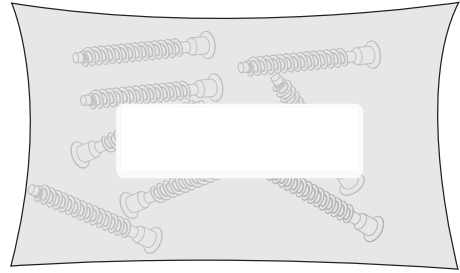

cod. 4157-4x

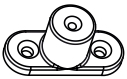

A

cod. 1669-8x

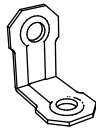

B

PASSA FIO
WIRE CHANNEL
PASAJE DE ALAMBRE
1x

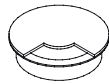

C

cod. 2014-3x

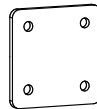

D

cod. 9070-5x

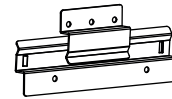

E

cod. 0348-2x



F

cod. 2088-10x



G

cod. 3557-51x

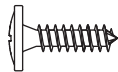

H

cod. 3706-24x



I

cod. 6244-10x



J

cod. 3527-16x

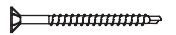

K

SUPORE TV
SUPPORT TV
SOPORTE TV
1X

L

KIT LED-1x

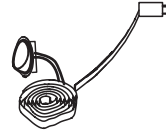

M

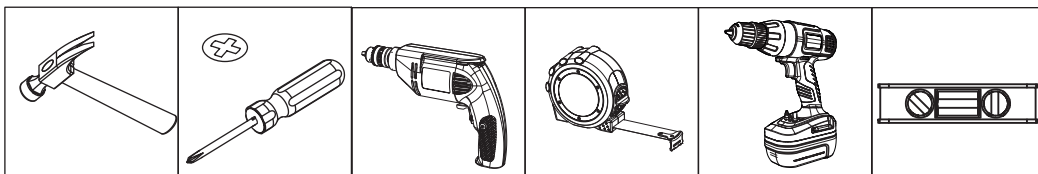

DESCRIPTION



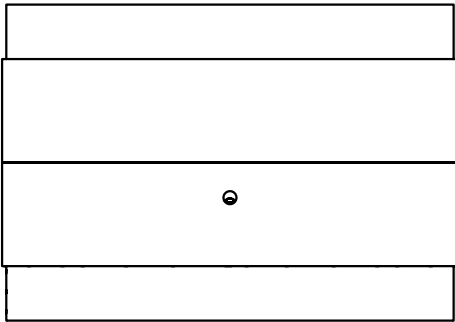

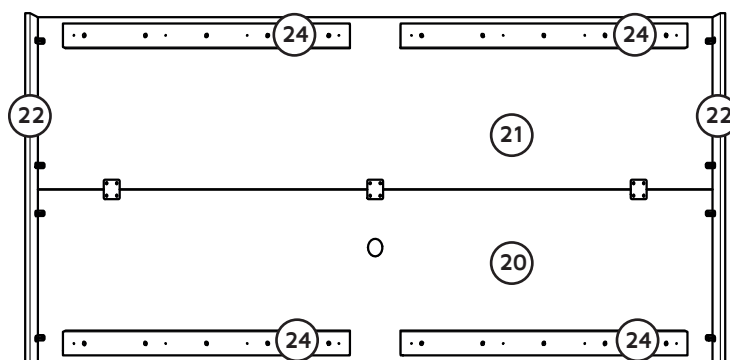
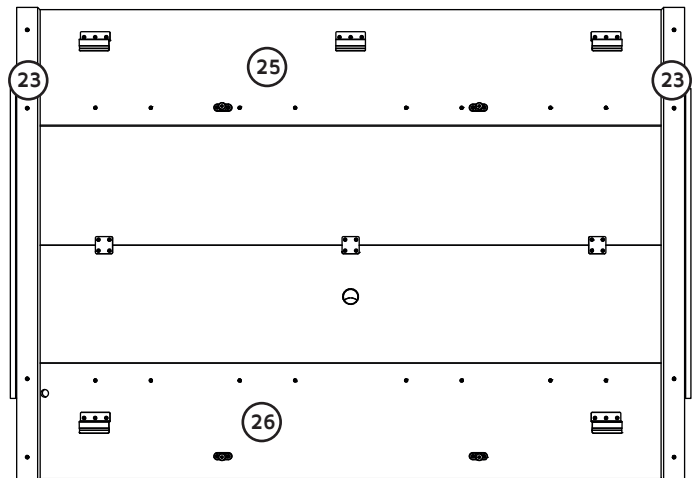

L:2170mm A:1352mm P:80 mm
 W:85.43 inches H:53.23 inches D:3.15 inches



CÓD:255000			
PART	QUANTITY	DESCRIPTION	BOX
20	01	BOTTOM PANEL	01
21	01	UPPER PANEL	01
22	02	PANEL SIDE	01
23	02	BACK SIDE SUPPORT	01
24	04	FRONT SUPPORT	01
25	01	UPPER BACK PANEL	01
26	01	BOTTOM PANEL	01



30Kg = 66Lb

cod. 1669  B	cod. 2014  D	cod. 0348  F	cod. 3557  H	cod. 3706  I	KIT LED  M
---	---	---	---	---	---

01

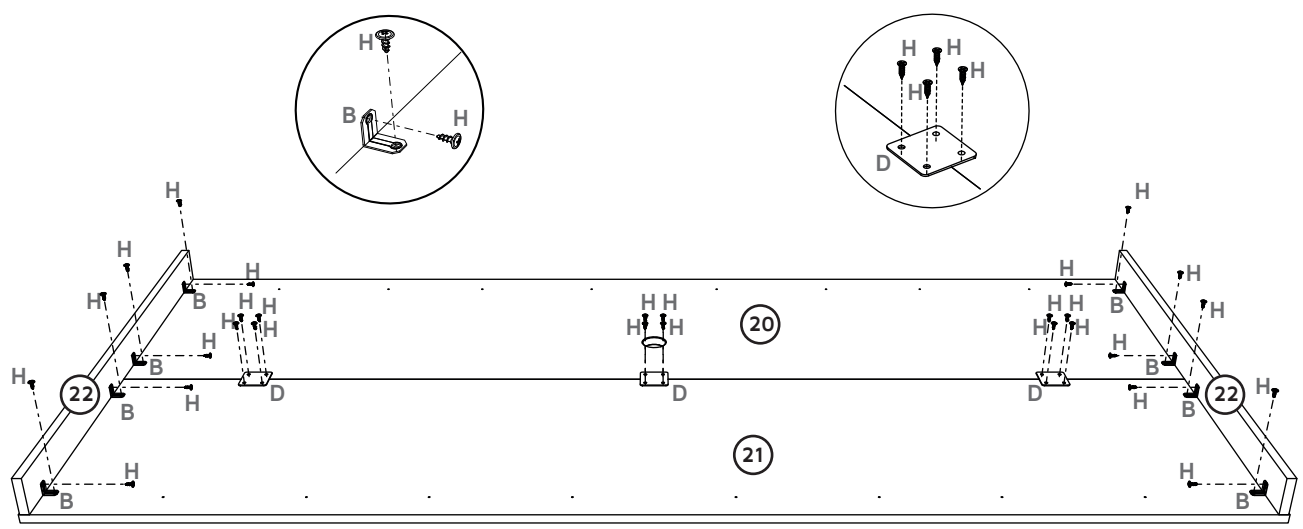

02

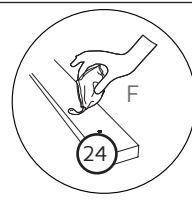

Use the PVA glue before screwing.

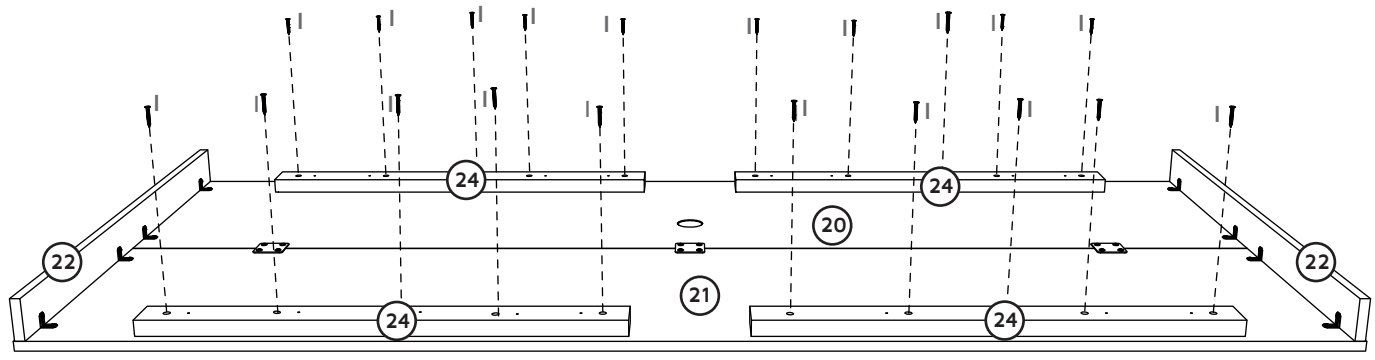

03







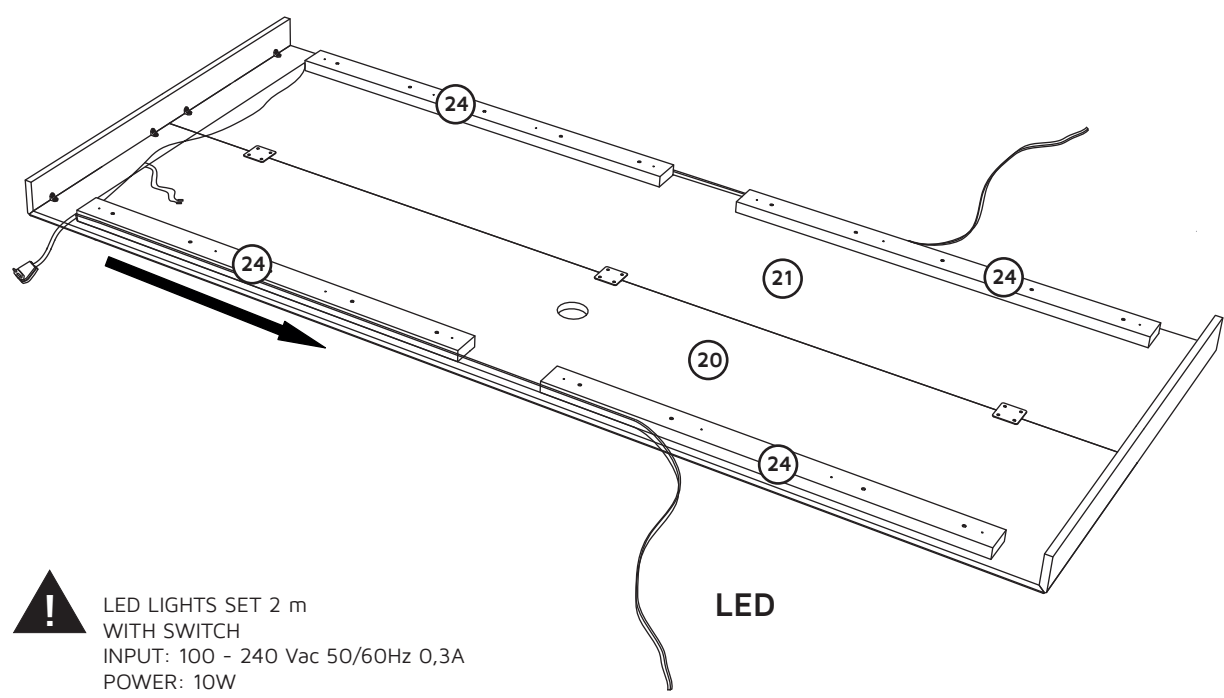

Attention

*The LED lights must be assembled in this step.



LED LIGHTS SET 2 m
WITH SWITCH
INPUT: 100 - 240 Vac 50/60Hz 0,3A
POWER: 10W
PROTECTION: IP20.

COD. 4157 A 	COD. 9070 E 	COD. 0348 F 	COD. 3557 H 	COD. 3706 I 	COD. 3527 K 	KIT LED M 
---	---	---	--	---	---	---

04

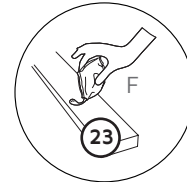
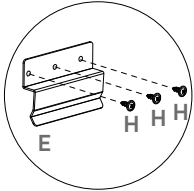
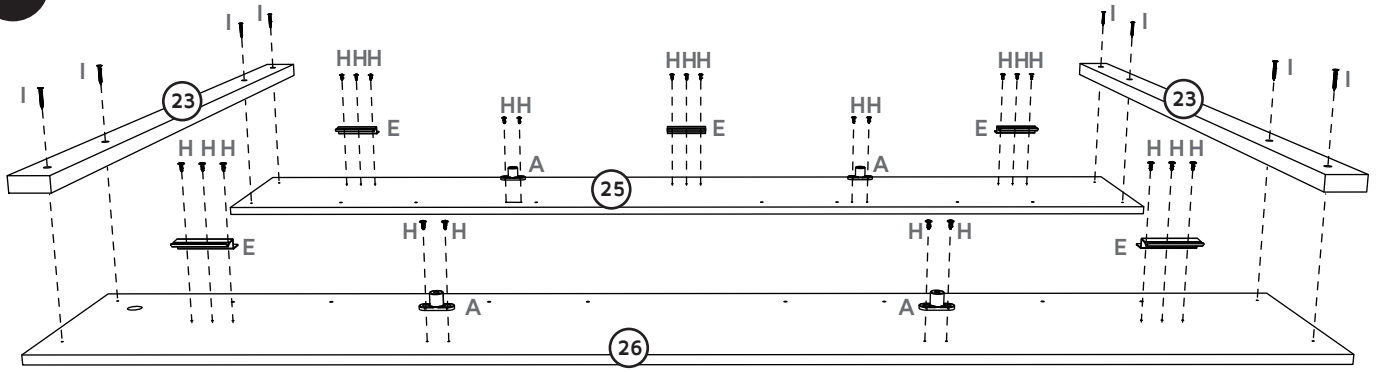

Use the PVA glue before screwing.

05



Attention

*The Switch must be assembled in this step.

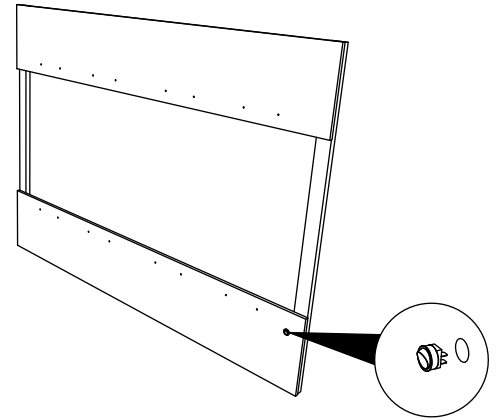
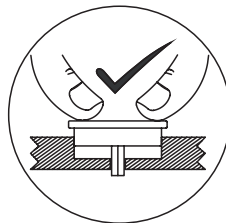
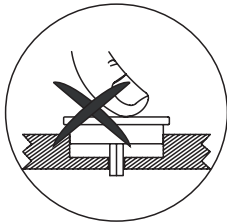

06

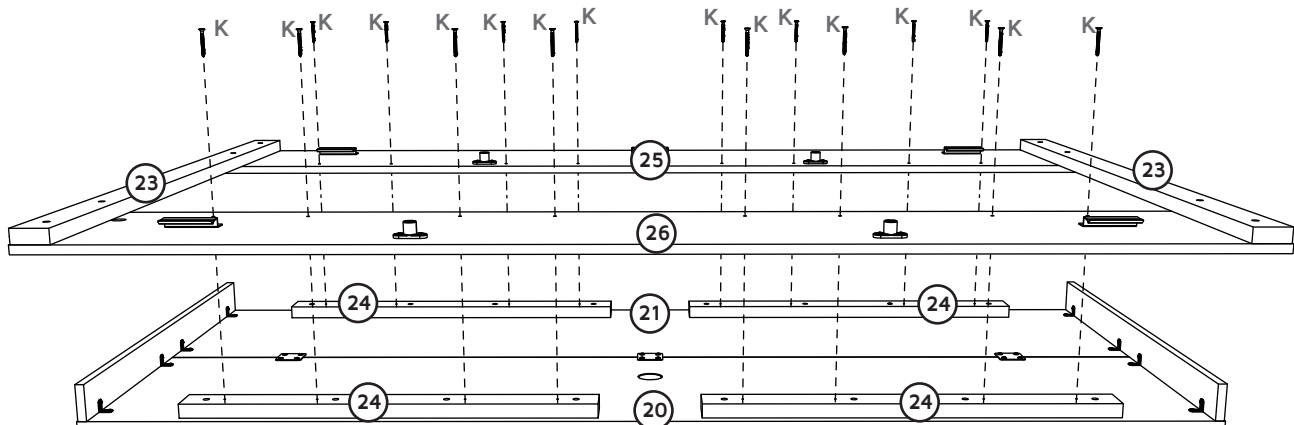
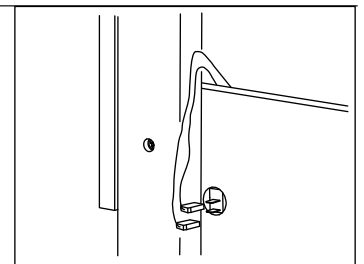

Measurement to drill the wall.

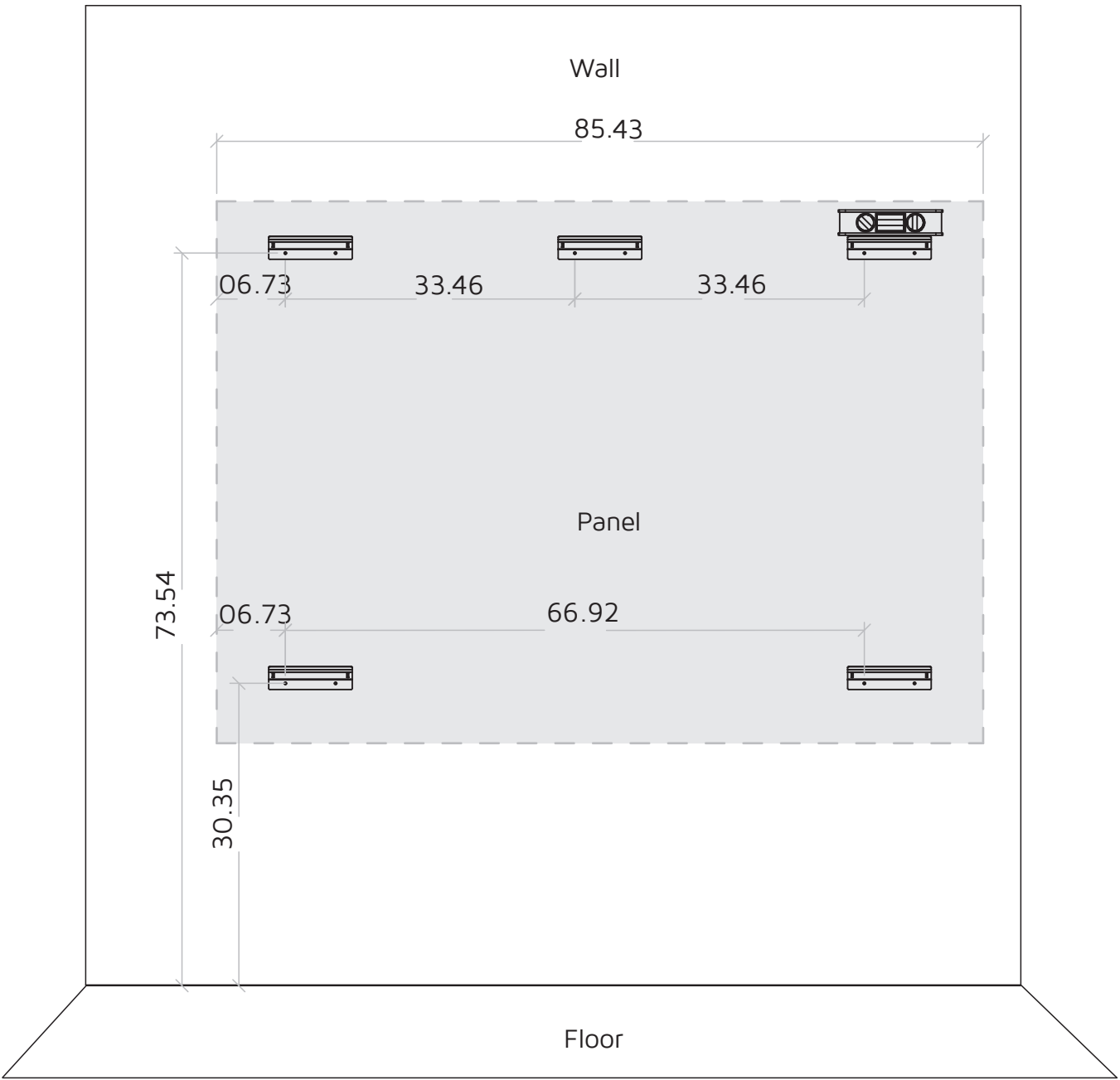
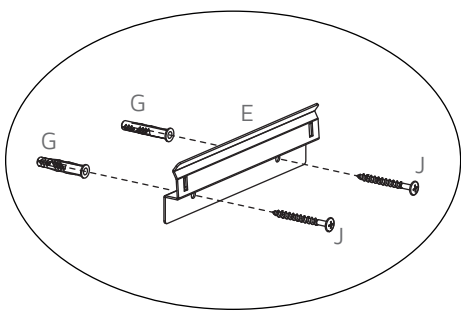
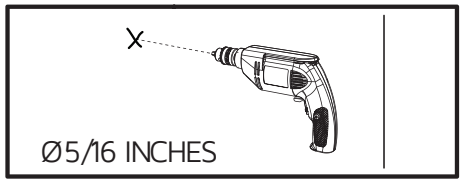
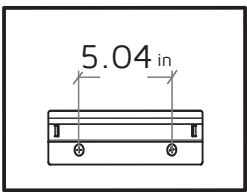

08

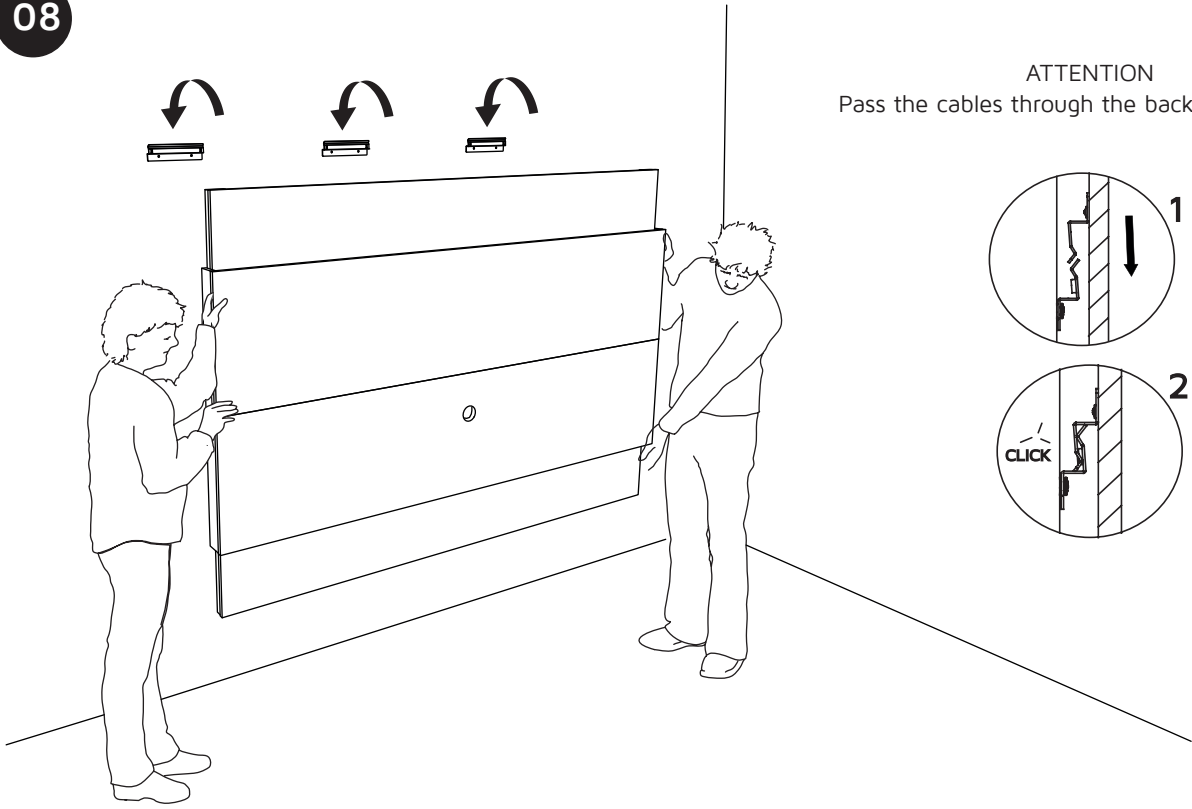

ATTENTION
Pass the cables through the back before Panel.

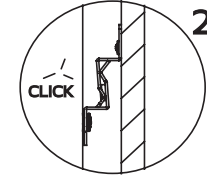
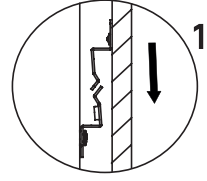

09

