

## CARE AND MAINTENANCE

Store outdoor furniture indoors or cover well when not in use.

Remove wooden furniture from standing water. Dust regularly with small brush or vacuum

Spills should be taken care of immediately before they harden or stain with a slightly dampened sponge.

## NOTICE





- \* Please make sure that you have all parts indicated before you begin assembly of this item
- \* This item should be assembled on a soft surface to prevent scratching the finish during assembly
- \* This item may require periodic tightening

**Warning : Do not stand on chair**

**Warning : Do not over torque bolts / screws**

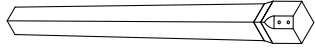
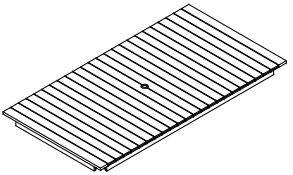

## Part List and Hardware List

PIECE	DESCRIPTION	PICTURE	QUANTITY
A	Leg Table		4X
B	Frame Table		1X
C	Bolt	 M8x60	8X
D	Washer	 M8.5/20X20	8X
E	Allen key	 LG4	1X

Model# CPT1017A

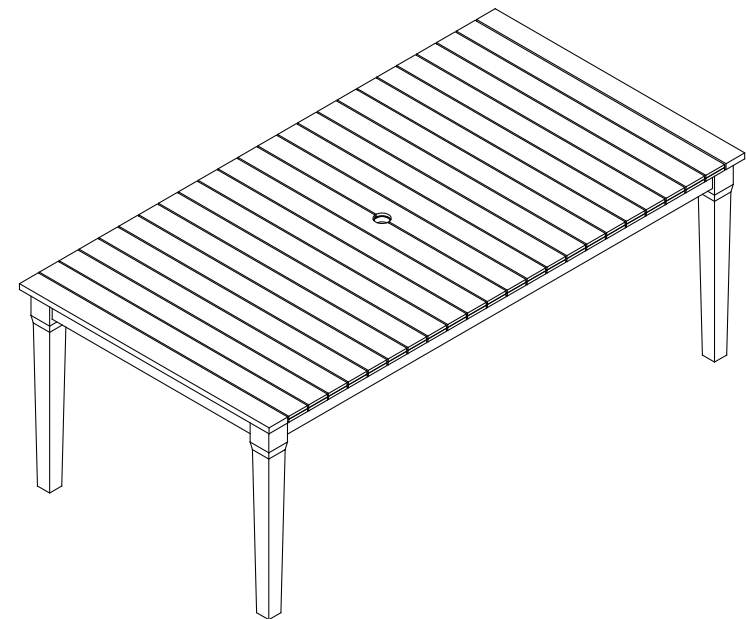

## PREPARATION

Before beginning assembly of product, make sure all parts are present. Compare parts with package contents list and hardware contents list. If any part is missing or damaged, do not attempt to assemble the product.

Estimated Assembly Time: 10 minutes.

Tools Required for Assembly (included): Allen Key

1

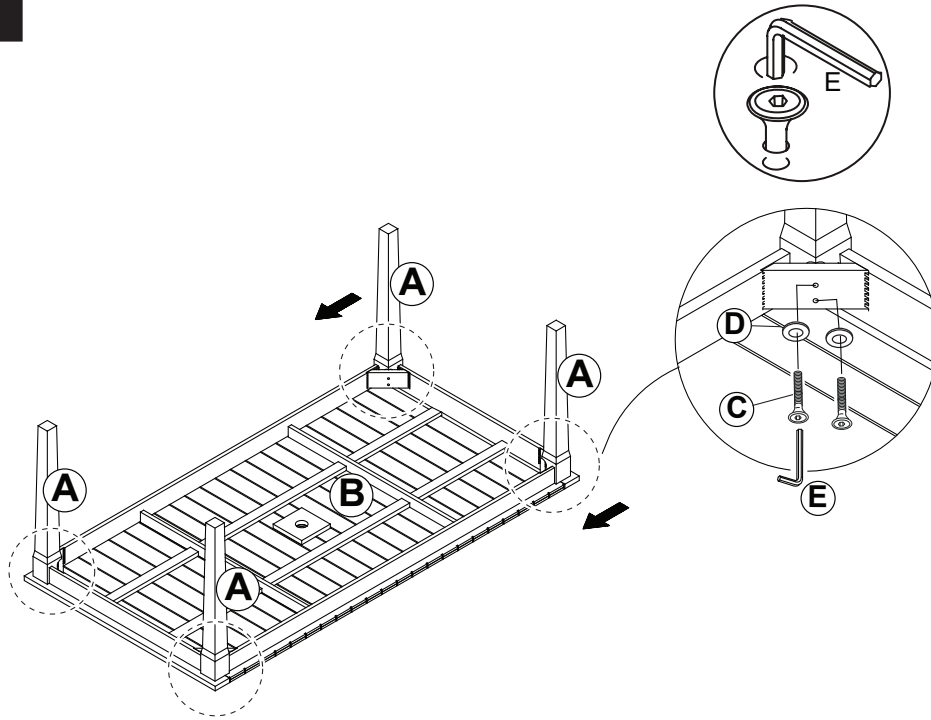

2

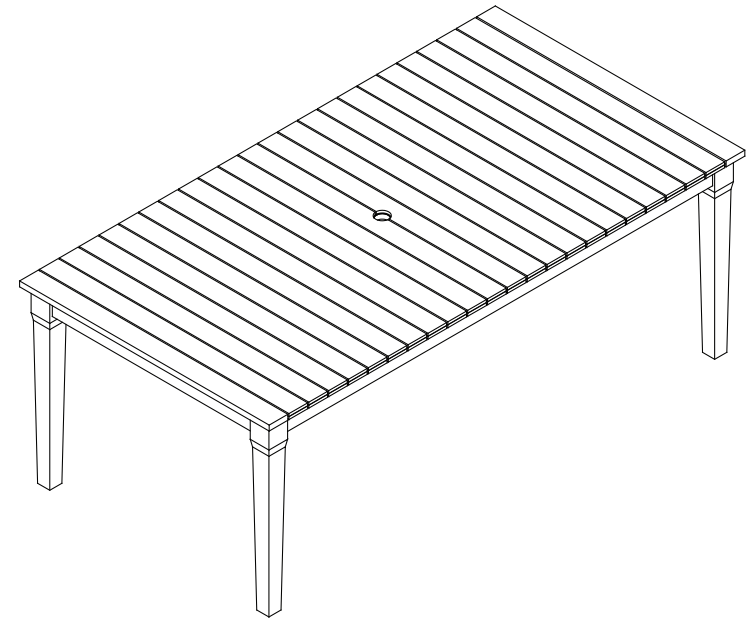

### Step 1

Attach leg frame (A) to Frame Table (B) ,use Bolt (C) and Washer (D) tighten with allen key (E).

### Step 2

Complete.