

SINGLE SOFA

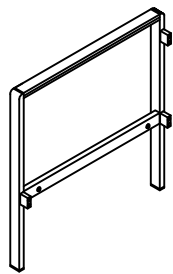

A*2PCS

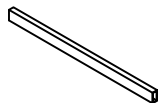

B*1PC

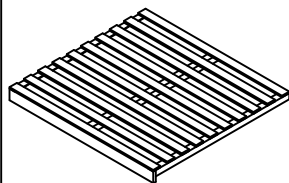

C*1PC

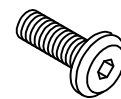

D:M6*20*4PCS

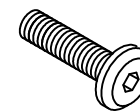

E:M6*25*6PCS

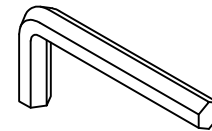

F:4MM*1PC

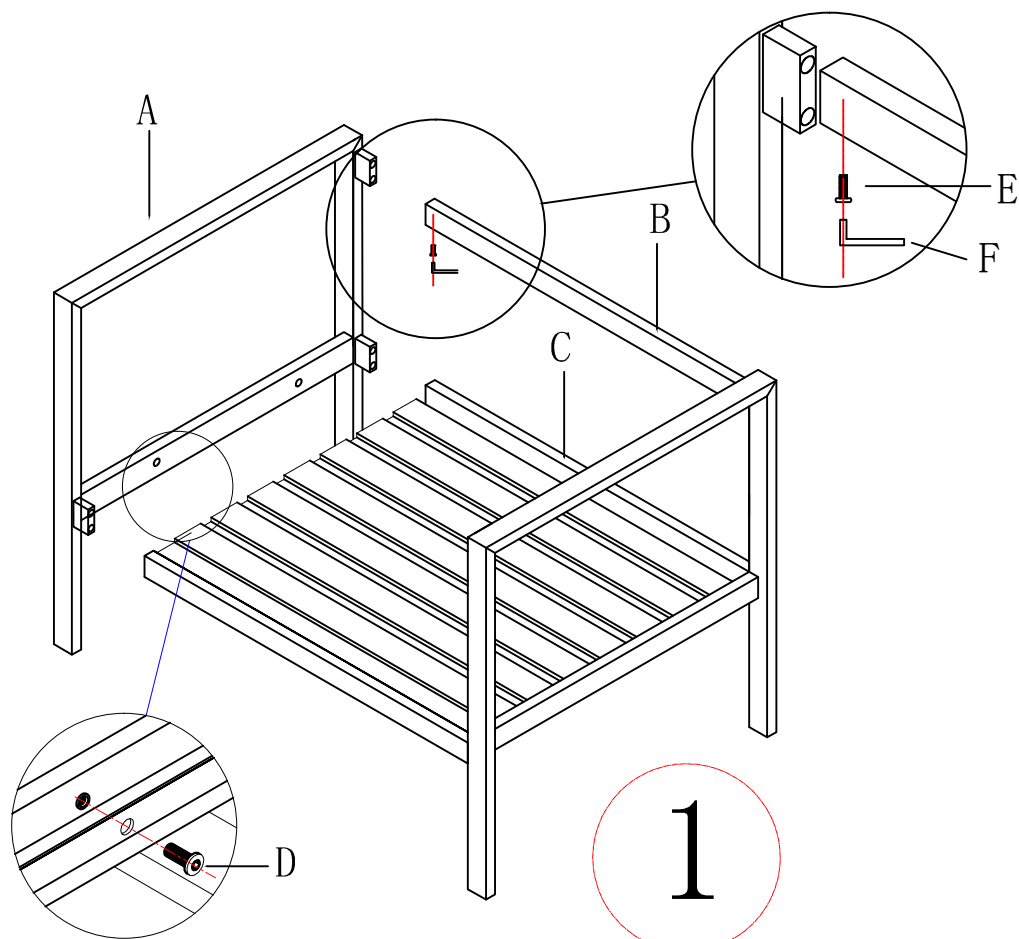

1

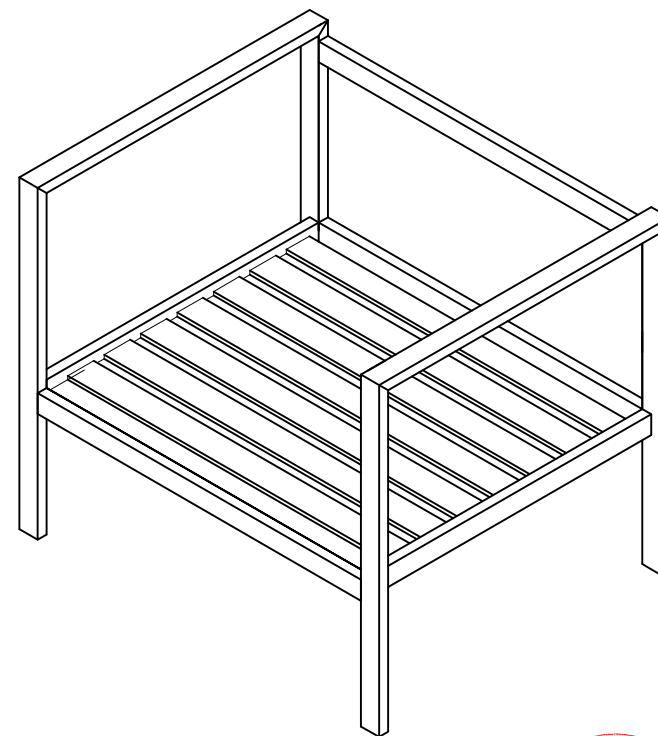

2