

# Cabinet

Assembly Instruction - Please keep properly for future reference.

If you find any missing boxes, damaged parts, or accessory shortages, please contact the customer service team of your purchasing channel immediately. We will resolve the issue as quickly as possible.

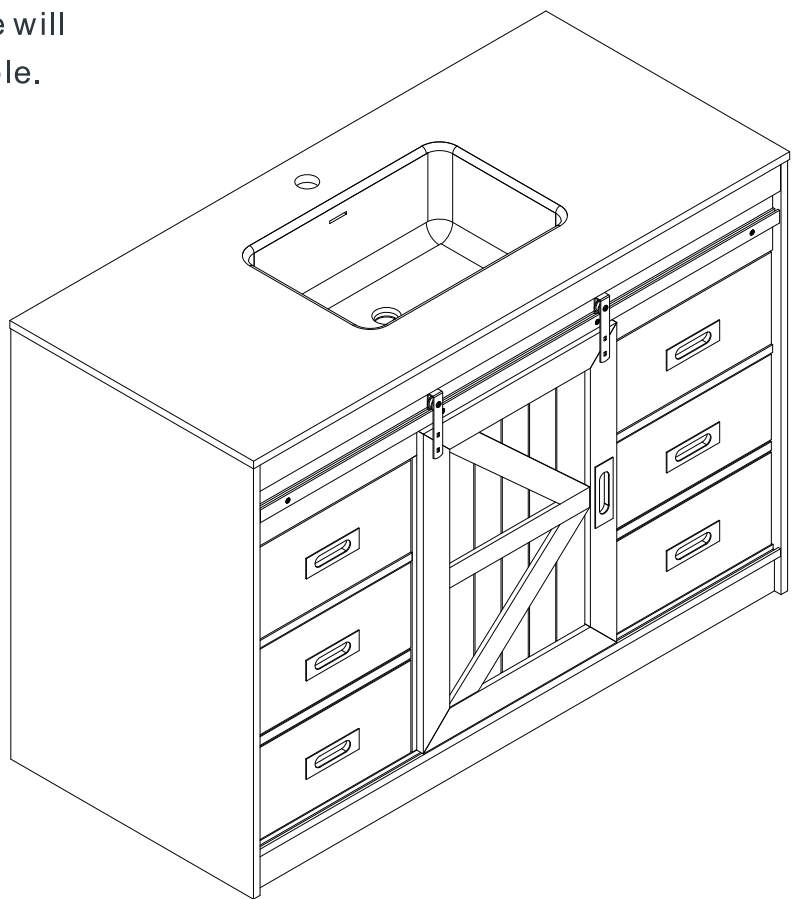

## Dimensions

Width - 47.8 inch  
Depth - 21.7 inch  
Height - 33.7 inch

EN

## THE FOLLOWING INFORMATION:

- Order number
- Purchase platform
- Purchase date
- Detailed description of the issue along with photos (if applicable)

**Important** – Please read these instructions carefully before starting the installation.



# Safety and Care Advice

**Important – Please read these instructions fully before starting assembly**

- Check you have all the components and tools listed on the following pages.
- Remove all fittings from the plastic bags and separate them into their groups.
- Keep children and animals away from the work area, small parts could choke if swallowed.
- Make sure you have enough space to layout the parts before starting.

- During assembly do not stand or put weight on the product, this could cause damage.
- Assemble the item as close to its final position (in the same room) as possible.
- Assemble on a soft level surface to avoid damaging the unit or your floor.
- Parts of the assembly will be easier with 2 people.



- To reduce the likelihood of damaging your product please ensure that your power drill is set on a low torque setting.

## Care and maintenance

- Only clean using a damp cloth and mild detergent, do not use bleach or abrasive cleaners.
- From time to time check that there are no loose screws on this unit.
- This product should not be discarded with household waste. Take to your local authority waste disposal centre.

## Handy Hints

- Assemble all parts and bolts loosely during assembly, only once the product is complete should you fully tighten the bolts
- Regularly check and ensure That all bolts and fittings are tightened properly.

## **WARNING**

**In order to help prevent overturning – please follow these instructions**

To help prevent product toppling over please follow the below steps:













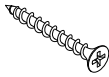

Use the anti tip strap or wall fixing method provided (if applicable)  
Do not allow children to climb or hang on the furniture  
Do not open more than one drawer at a time  
Do not place heavy items in the top drawers  
Do not place heavy items on top of the furniture, unless the furniture has been designed for this purpose

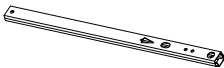
Please note that only the anti tip strap is provided.  
You will need to provide wall plugs and screws applicable for your wall type

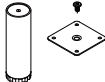
# Pars List-Fittings

Please check you have all the fittings listed below

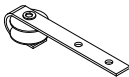
**Note:** The quantities below are the correct amount to complete the assembly. In some cases more fittings may be supplied than are required.

<p><b>A</b></p>  <p>Cam Bolt x 45</p>	<p><b>B</b></p>  <p>Cam Lock x 45</p>	<p><b>C</b></p>  <p>Wooden Dowel x 30</p>
<p><b>D</b></p>  <p>3.5*14mm Screw x 28</p>	<p><b>E</b></p>  <p>5*40mm Screw x 23</p>	<p><b>F</b></p>  <p>4*14mm Screw x 8</p>
<p><b>G</b></p>  <p>Drawer Slide x 8</p>	<p><b>H</b></p>  <p>Allen Key x 1</p>	<p><b>I</b></p>  <p>6*30mm Bolt x 4</p>
<p><b>J</b></p>  <p>Adjustable Foot(Hx75mm) x 1</p>	<p><b>K</b></p>  <p>Protective Foot x 5</p>	<p><b>L</b></p>  <p>L shape bracket x 2</p>
<p><b>M</b></p>  <p>Screw and plastic cap x 2</p>	<p><b>N</b></p>  <p>Pulley x 2</p>	<p><b>O</b></p>  <p>4*12mm Screw x 8</p>
<p><b>P</b></p>  <p>Wall Fixing Pack x 3</p>		

## Tools required



Phillips screwdriver  
(medium & large)

Ruler - Use this ruler to help correctly identify the screws

mm

0 5 10 15 20 25 30 35 40 45 50 55 60 65 70 75 80 85 90 95 100 105 110 115 120 125 130 135 140 145 150 155 160 165 170



The screws length is measured from the head to the point (30mm screw shown).

0 1 2 3

inch

# Using Camlocks

## Step 1

Connect the male camlock as directed in the assembly instructions using a screwdriver.

1

DO NOT OVER TIGHTEN.

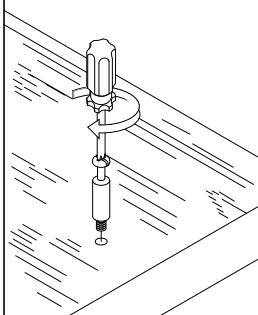

## Step 2

Push the male camlock into the entry hole.

2

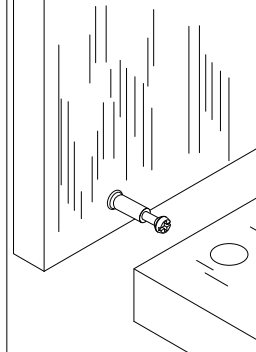

## Step 3

Insert the female camlock as shown in the instructions.

Note: ensure that the arrow on the top of the camlock points towards the entry hole for the male camlock.

3

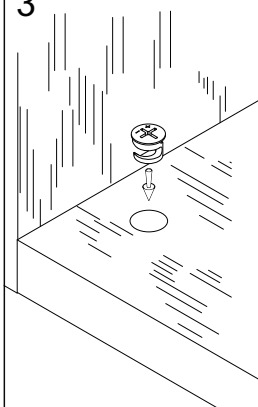

## Step 4

Turn the female camlock clockwise with a screwdriver.

You should feel a click when the camlock is locked in place.

The joint is now secure.

4

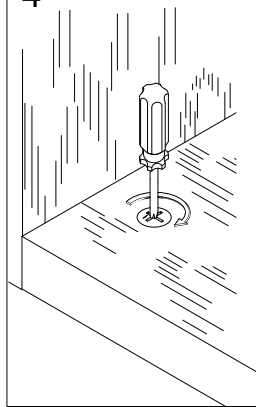

# Parts Lis-Panels

Please check you have all the panels listed below

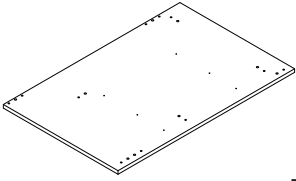
- 

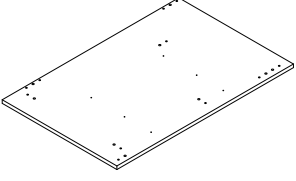
1 (85 x 55.2 x 1.5cm) x1
- 

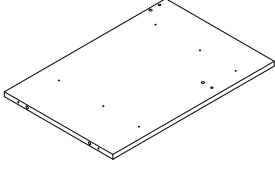
2 (85 x 55.2 x 1.5cm) x1
- 

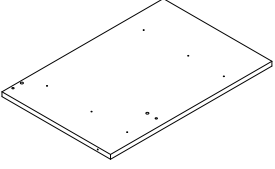
3 (58 x 39 x 1.5cm) x1
- 

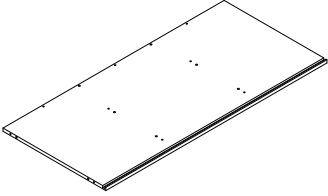
4 (58 x 39 x 1.5cm) x1
- 

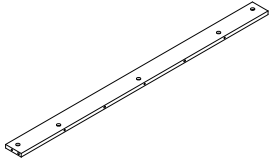
5 (118.5 x 55.1 x 1.5cm) x1
- 

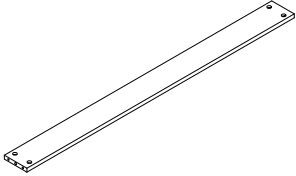
6 (118.5 x 7.5 x 1.5cm) x1
- 

7 (118.5 x 10 x 1.5cm) x1
- 

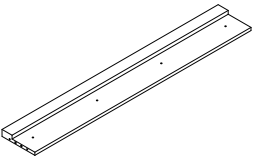
8 (118.1 x 2.5 x 1.5cm) x1
- 

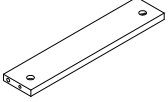
9 (118.5 x 18 x 3.3cm) x1
- 

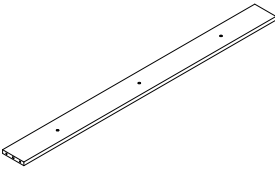
10 (36.5 x 7.5 x 1.5cm) x4
- 

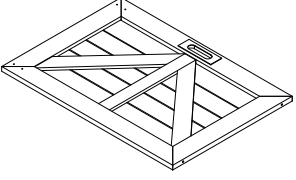
11 (118.5 x 10 x 1.5cm) x1
- 

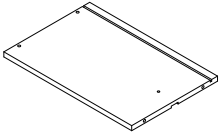
12 (63 x 44 x 1.5cm) x1
- 

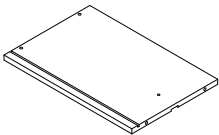
13 (35 x 23.5 x 1.2cm) x2
- 

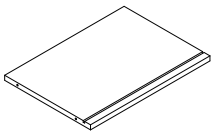
14 (35 x 23.5 x 1.2cm) x2
- 

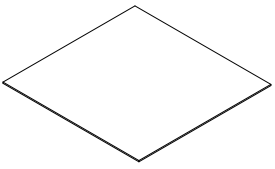
15 (32.7 x 23.5 x 1.2cm) x2
- 

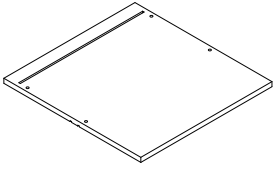
16 (34.5 x 33.5 x 0.27cm) x4
- 

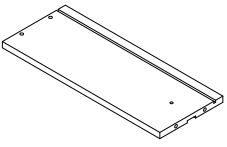
17 (37.5 x 35.9 x 1.5cm) x2
- 

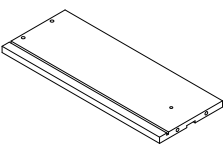
18 (35 x 14 x 1.2cm) x2
- 

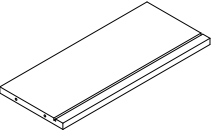
19 (35 x 14 x 1.2cm) x2
- 

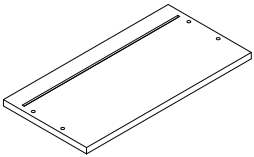
20 (32.7 x 14 x 1.2cm) x2
- 

21 (35.9 x 17.5 x 1.5cm) x2

# Assembly Instructions

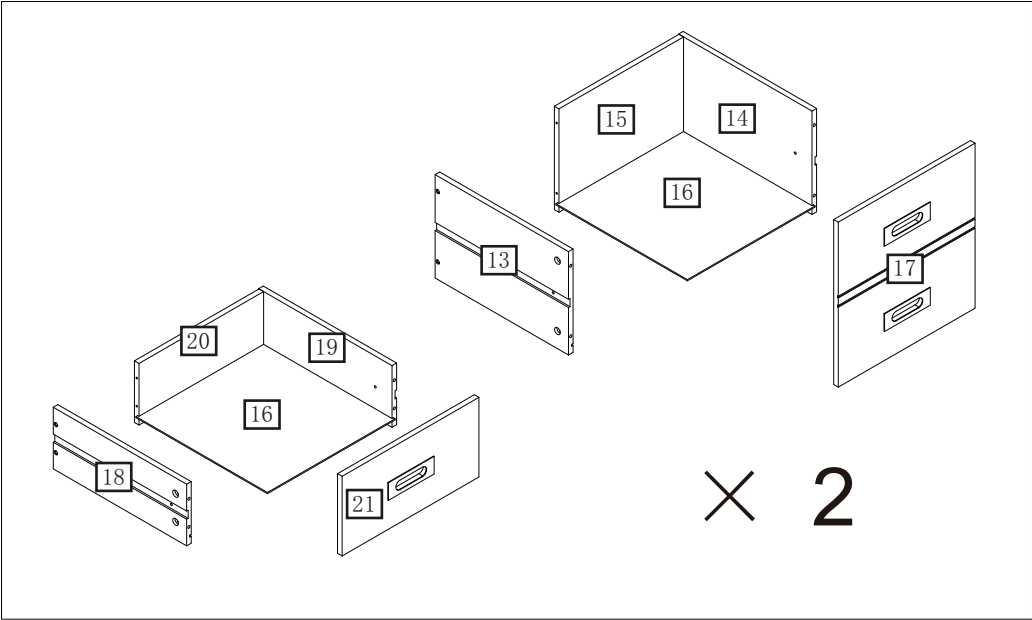
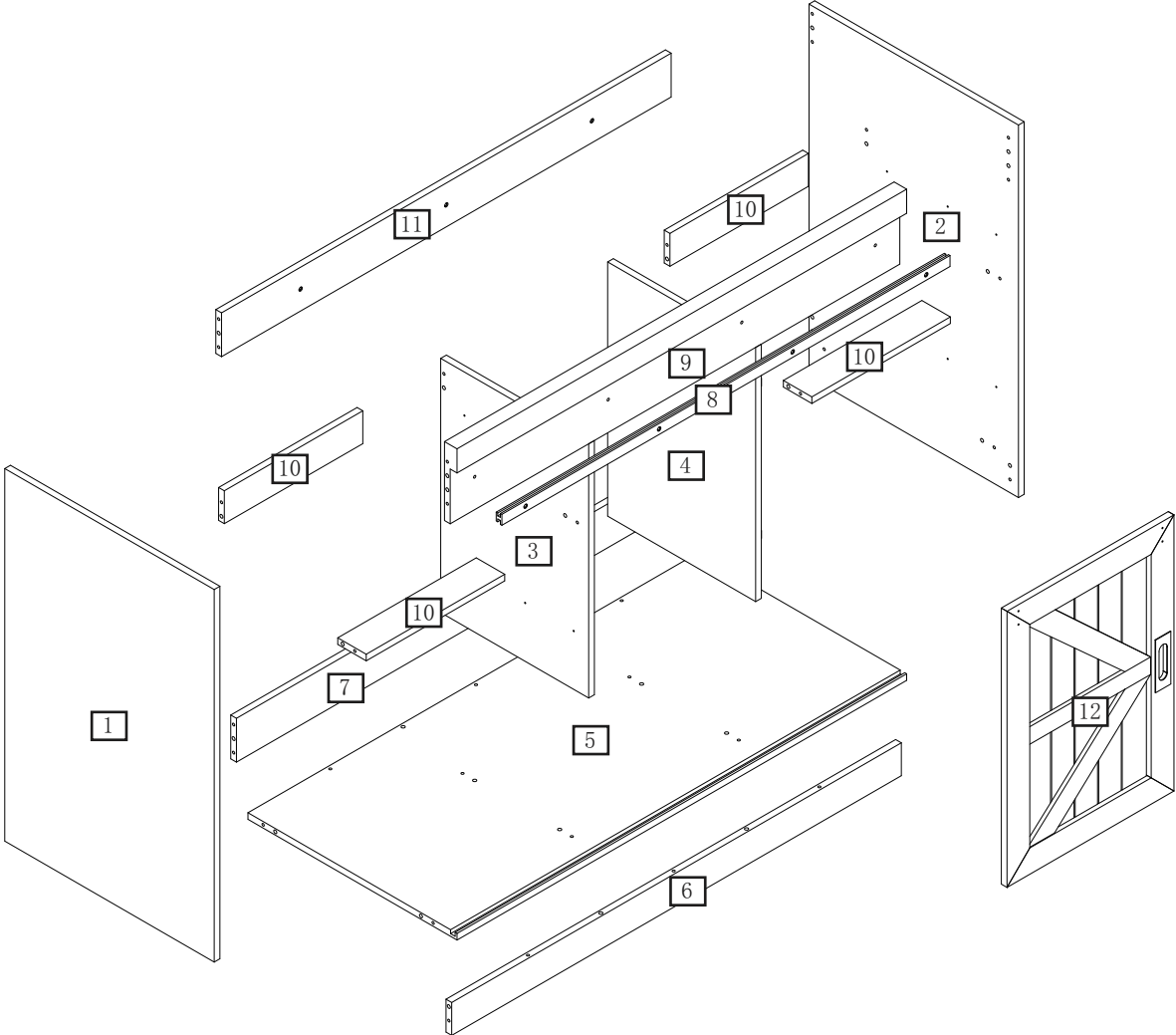

# Assembly Instructions

## Step 1

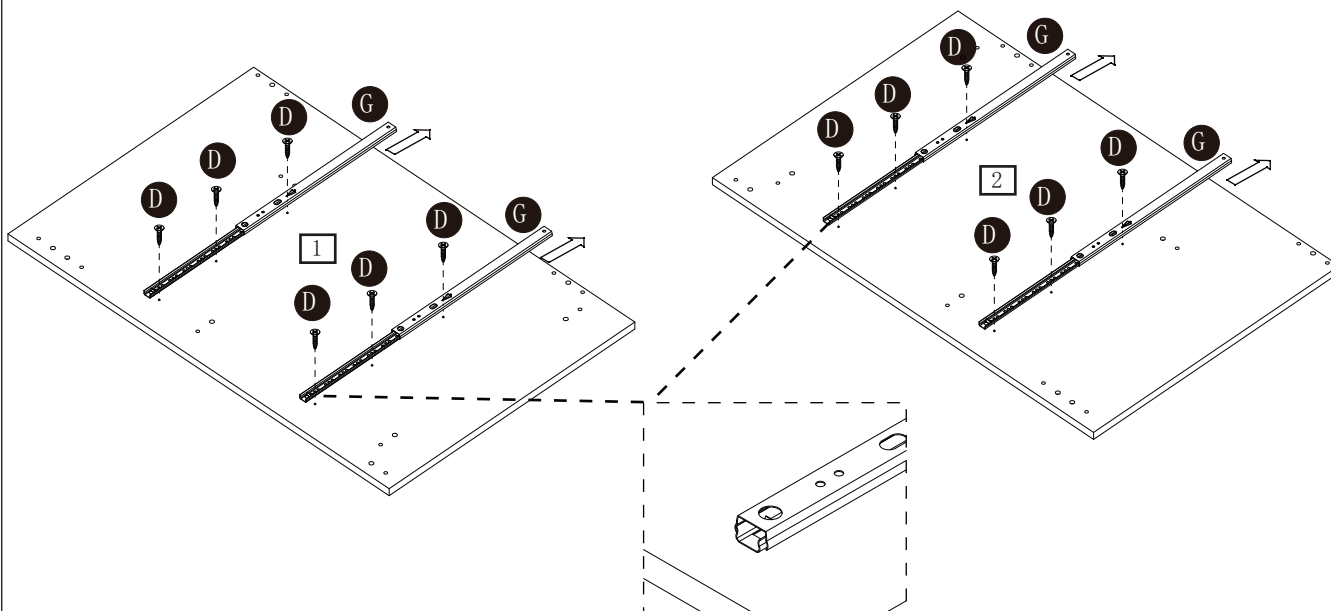
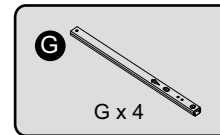
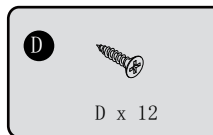

 **Note: Make sure the drawer slides are oriented correctly.**

1-1

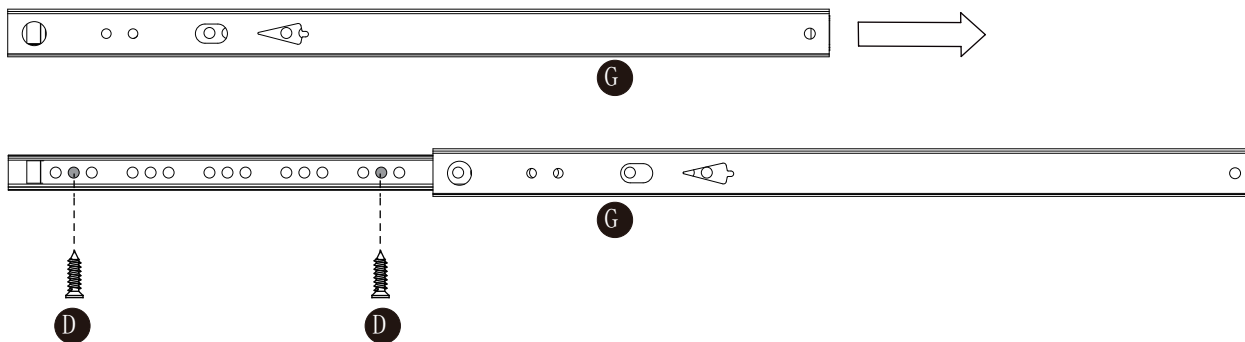

1-2

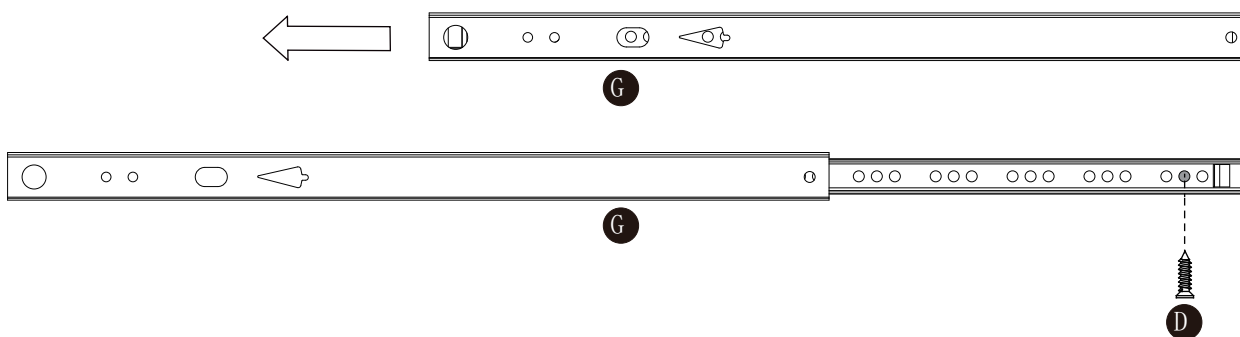

Attach drawer slide (G) to parts (1, 2) using scew (D) and a screwdriver.

# Assembly Instructions

## Step 2

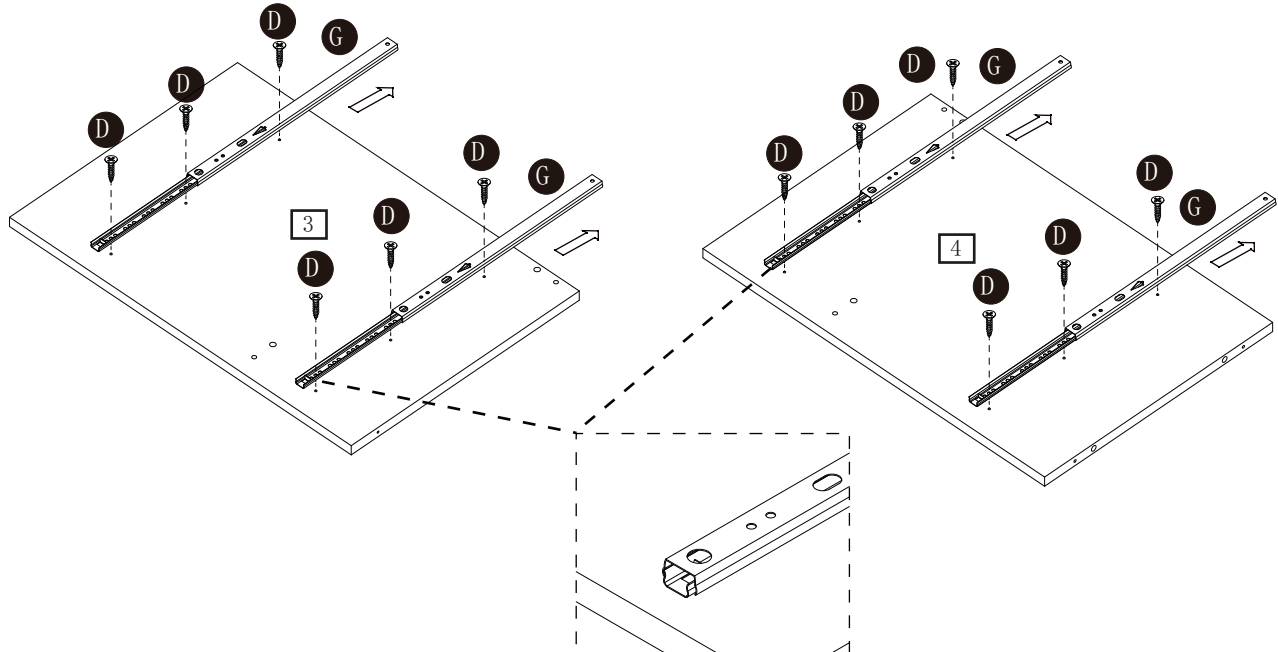
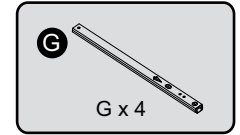
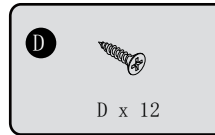

 **Note: Make sure the drawer slides are oriented correctly.**

### 2-1

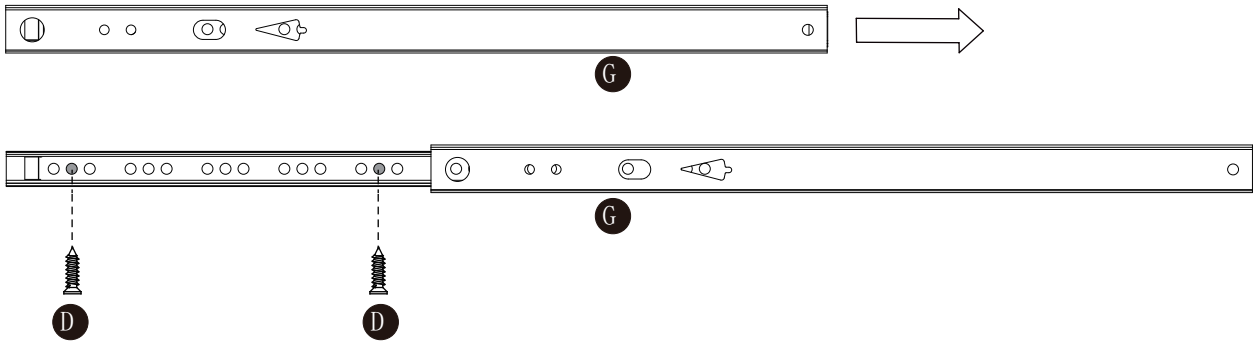

### 2-2

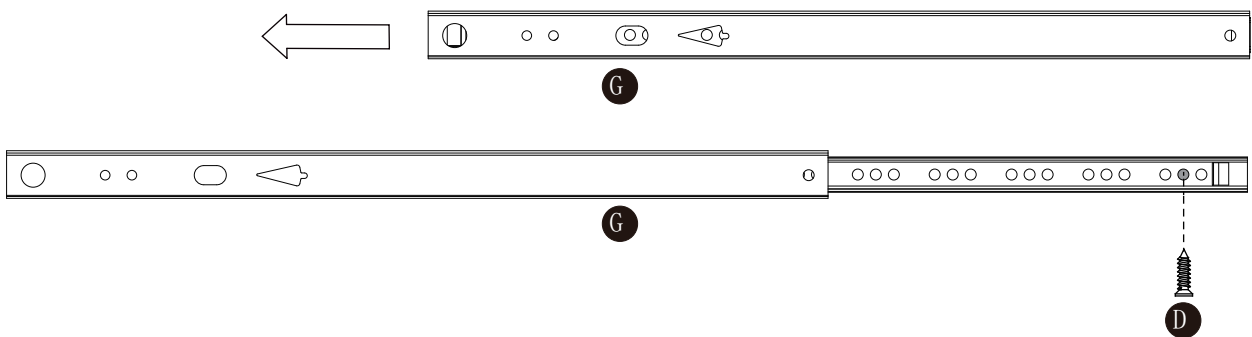

Attach drawer slide (G) to parts (3, 4) using scew (D) and a screwdriver.

# Assembly Instructions

## Step 3

### CAM-LOCK

Tighten until shoulder is flush with panel. Do not overtighten or undertighten (see example below)

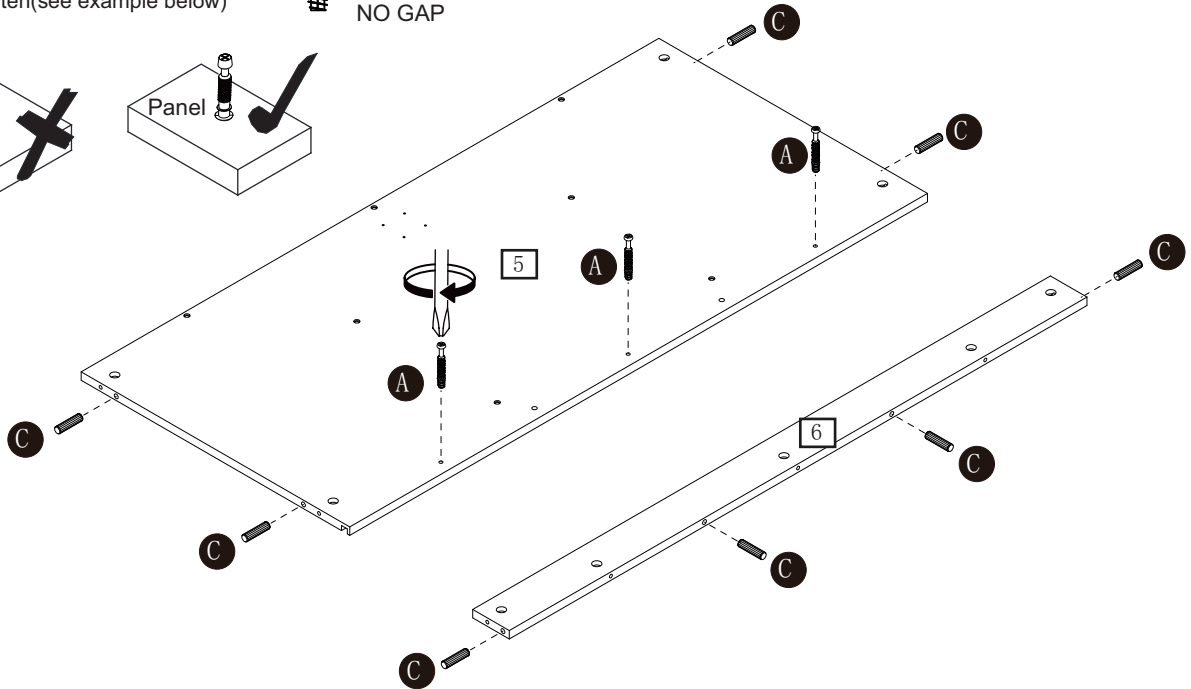
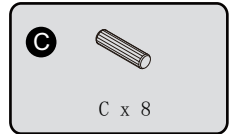
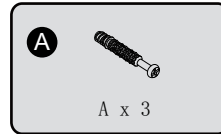
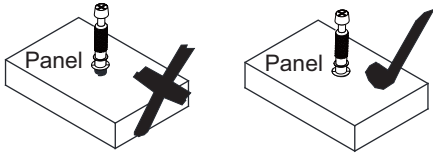

Attach cam bolt (A) to part (5) with a screwdriver.  
Insert wooden dowel (C) into parts (5, 6).

## Step 4

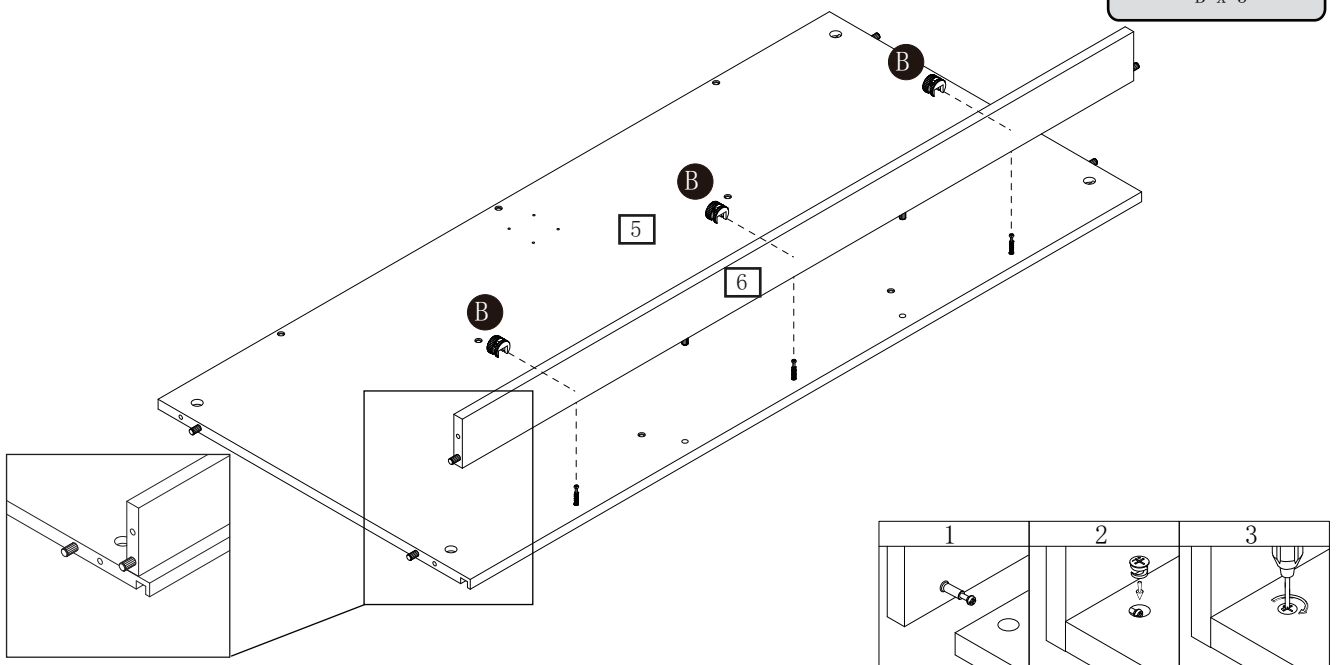

Attach part (6) to part (5), then insert and secure cam lock (B) into part (6) to lock it.

# Assembly Instructions

## Step 5

### CAM-LOCK

Tighten until shoulder is flush with panel. Do not overtighten or undertighten (see example below)

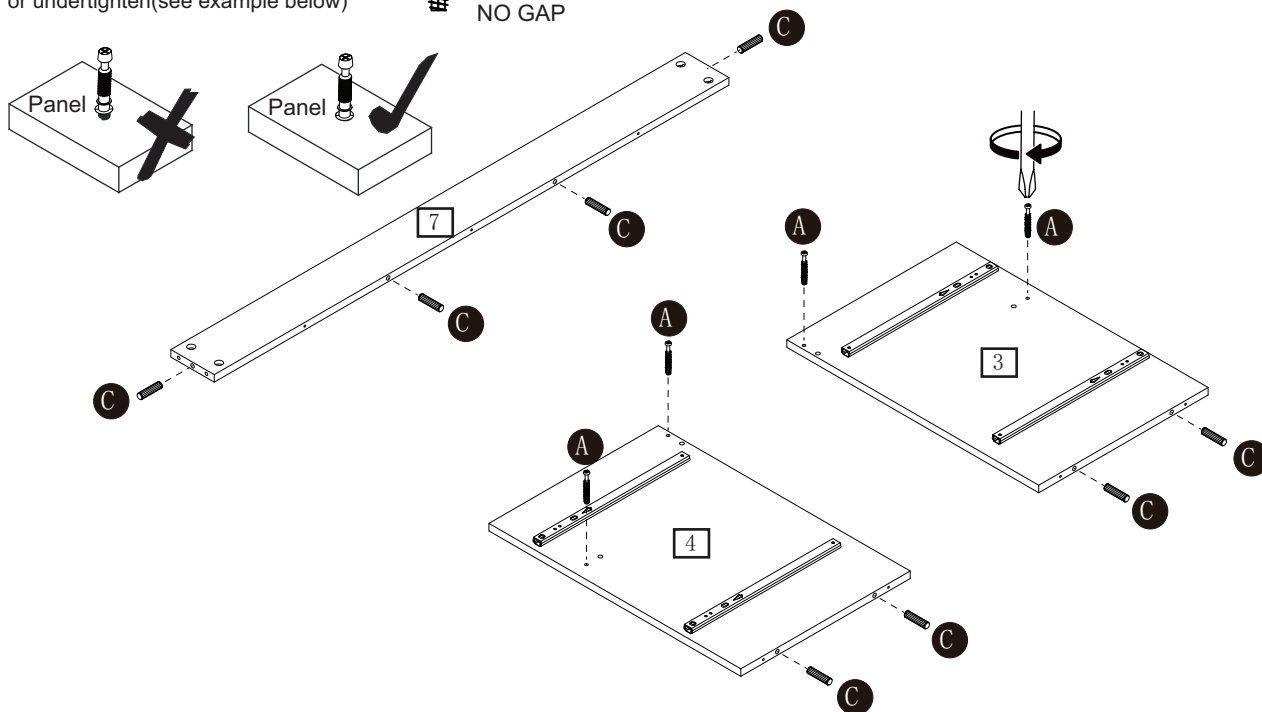
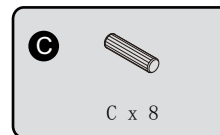
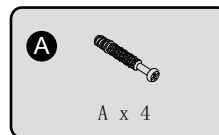
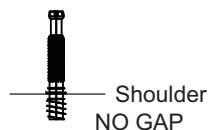

Attach cam bolt (A) to parts (3, 4) with a screwdriver.  
Insert wooden dowel (C) into parts (3, 4, 7).

## Step 6

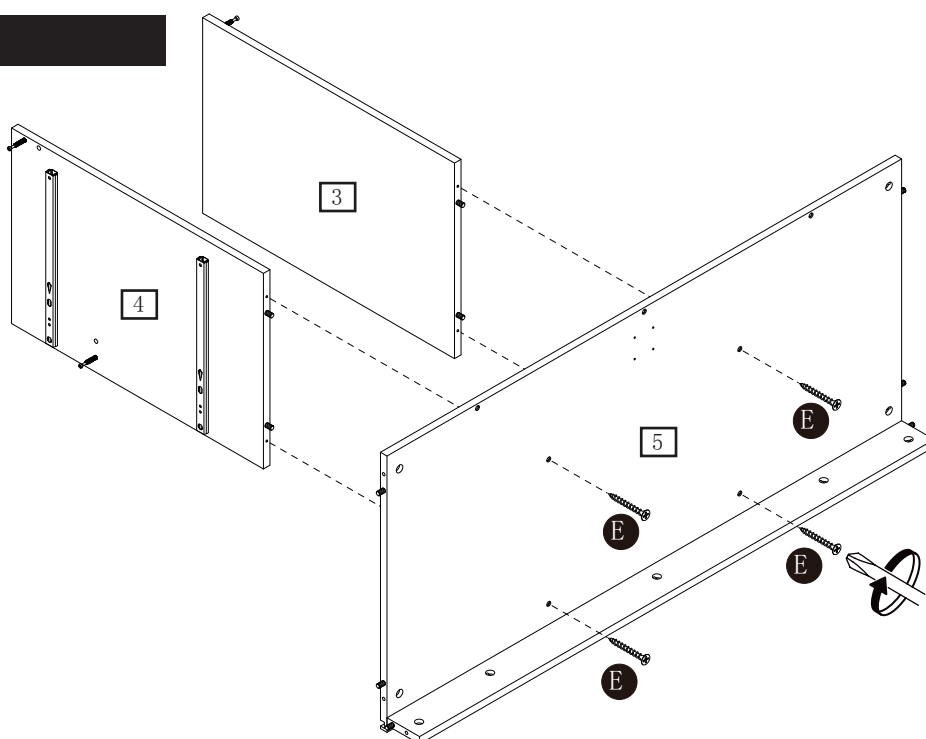
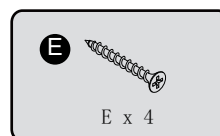

Attach parts (3, 4) to part (5) using screw (E) and a screwdriver.

# Assembly Instructions

## Step 7

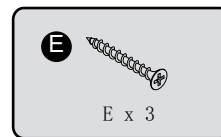
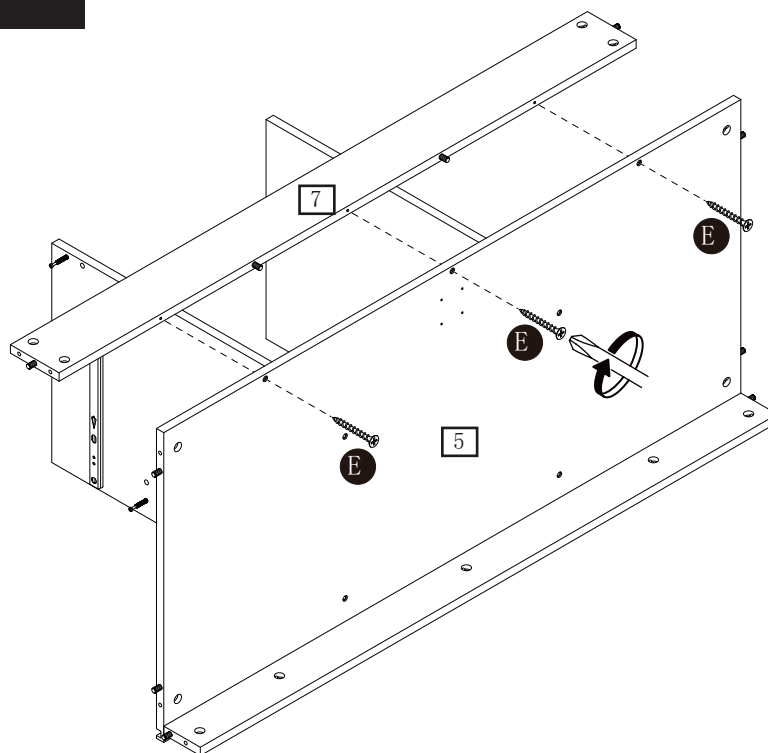

Attach part (7) to part (5) using screw (E) and a screwdriver.

## Step 8

### CAM-LOCK

Tighten until shoulder is flush with panel. Do not overtighten or undertighten (see example below)

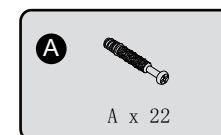
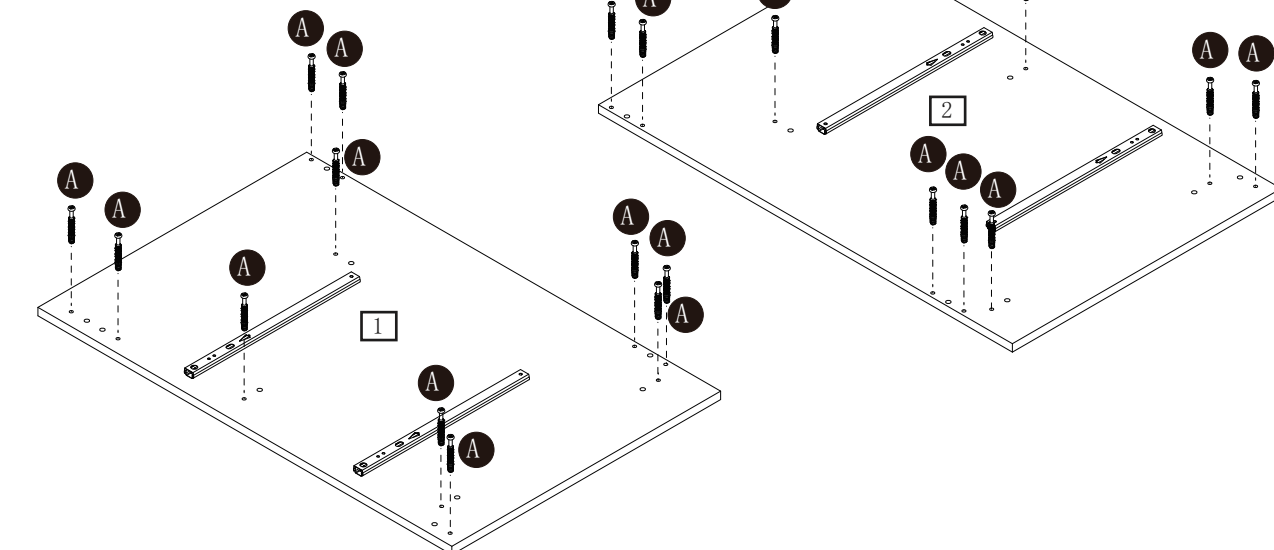
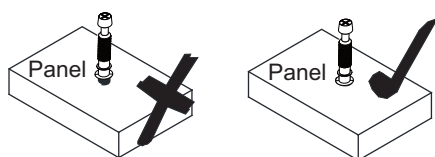

Attach cam bolt (A) to parts (1, 2) with a screwdriver.

# Assembly Instructions

## Step 9

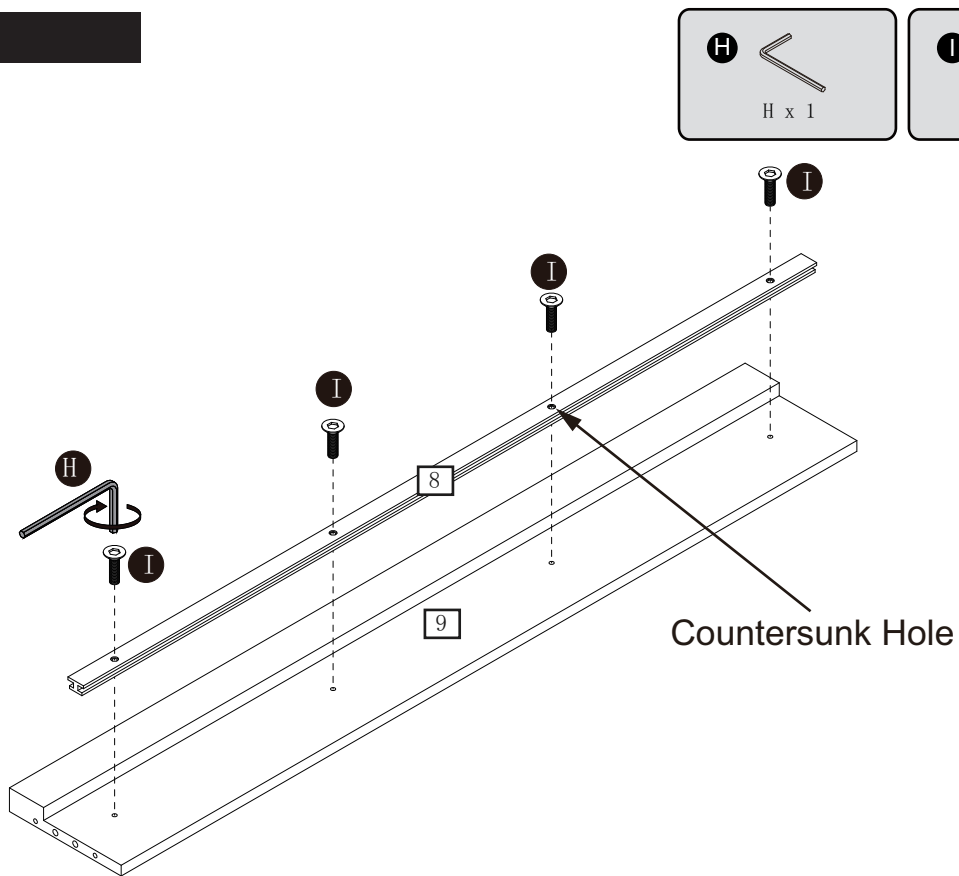

Attach part (8) to part (9) using bolt (I) and allen key (H).

## Step 10

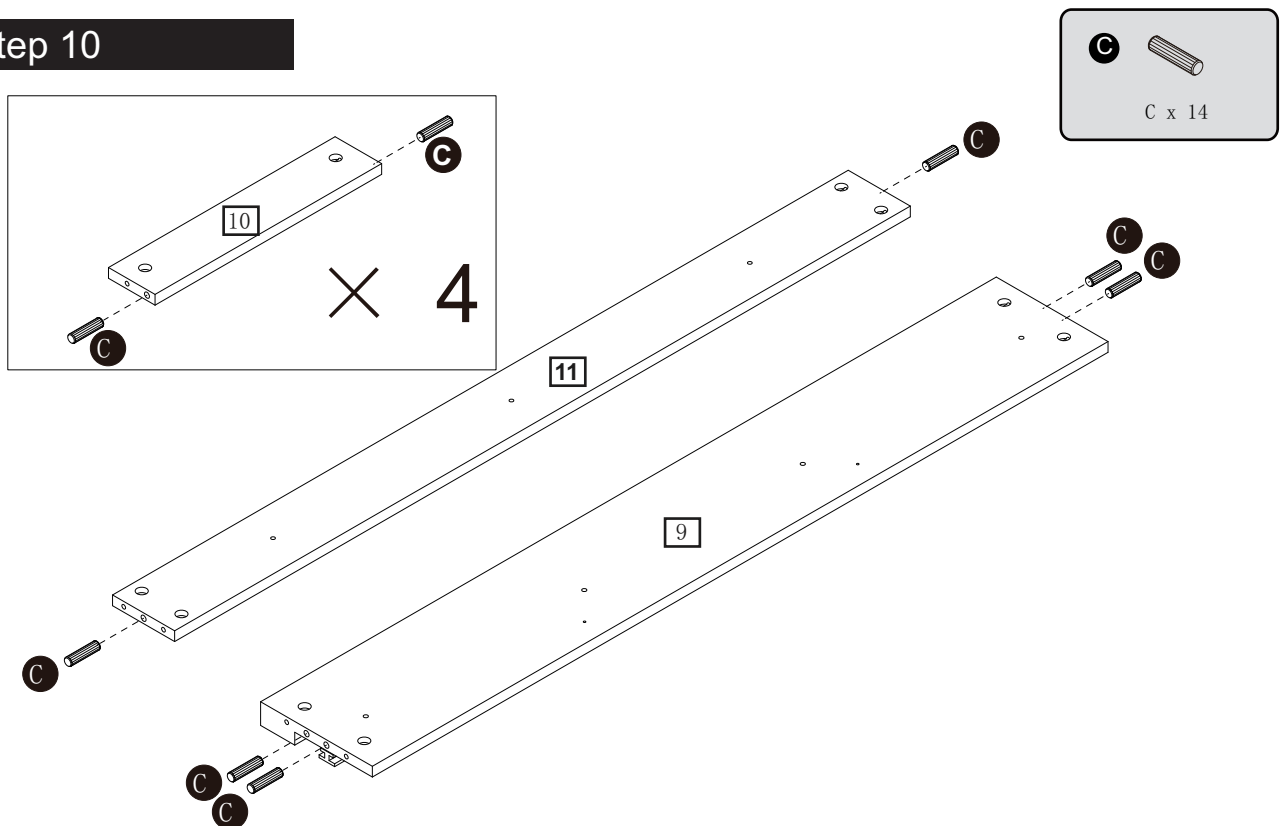

Insert wooden dowel (C) into parts (9, 10, 11).

# Assembly Instructions

## Step 11

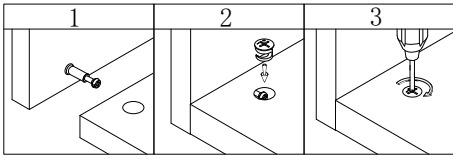
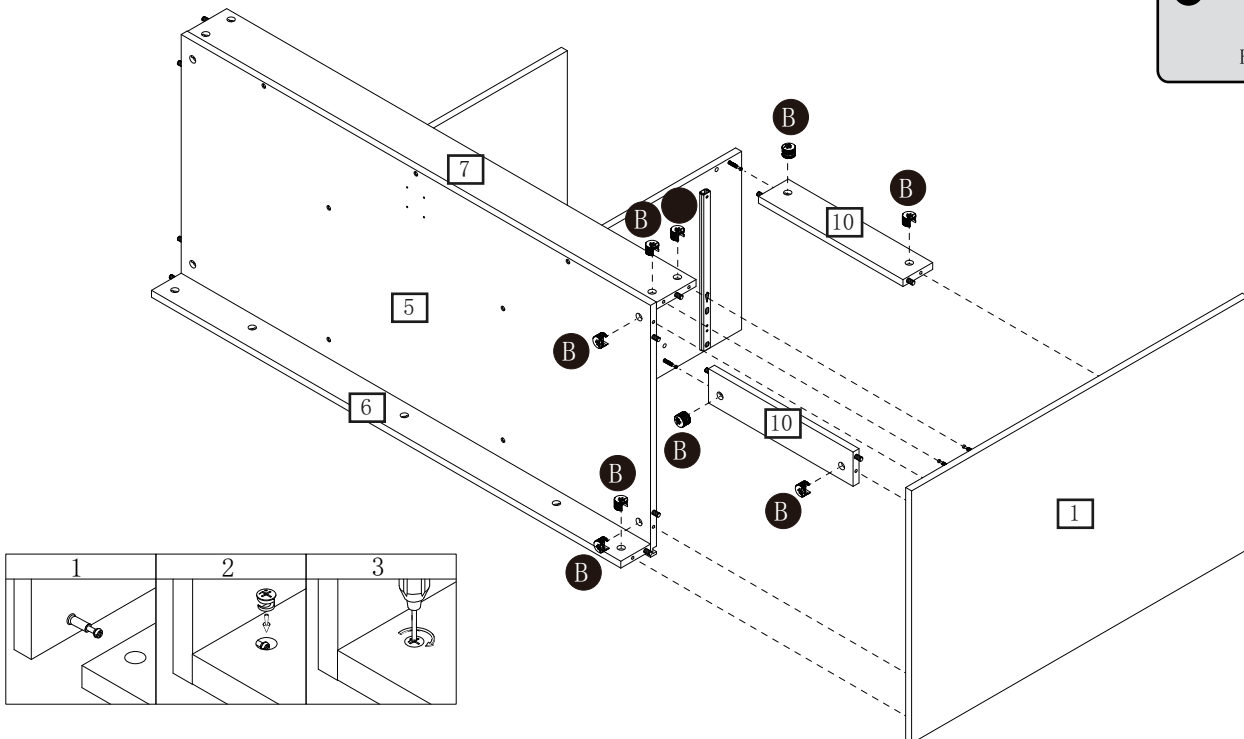

Attach part (1) to parts (5, 6, 7, 10), then insert and secure cam lock (B) to parts (5, 6, 7, 10) to lock them.

## Step 12

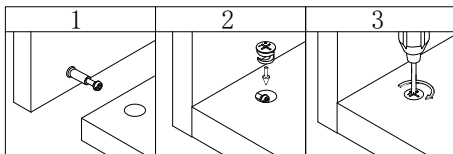
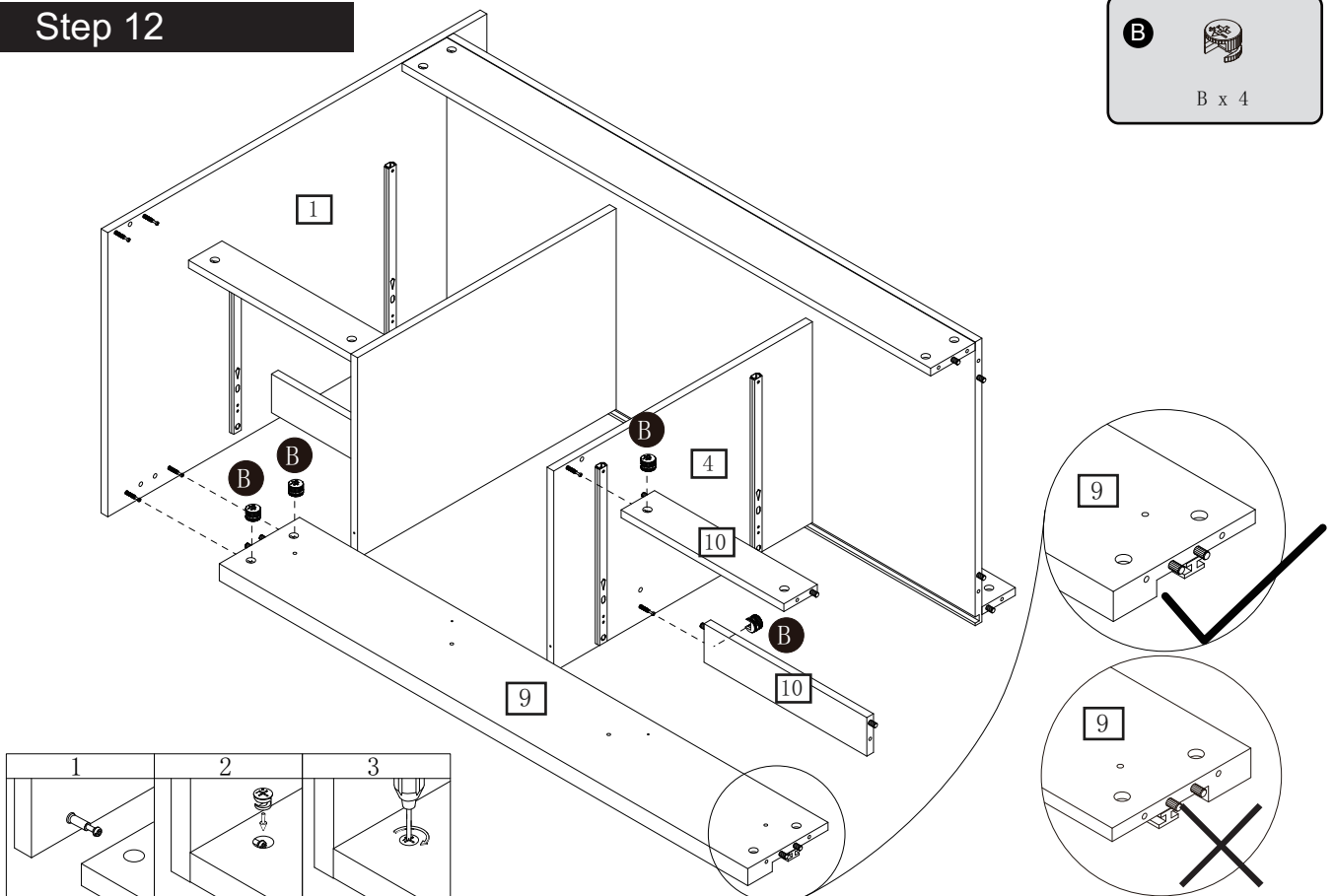

Attach part (9) to part (1), then insert and secure cam lock (B) to part (9) to lock it.  
Attach part (10) to part (4), then insert and secure cam lock (B) to part (4) to lock it.

# Assembly Instructions

## Step 13

B



B x 13

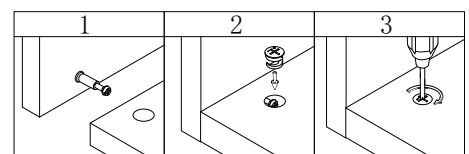
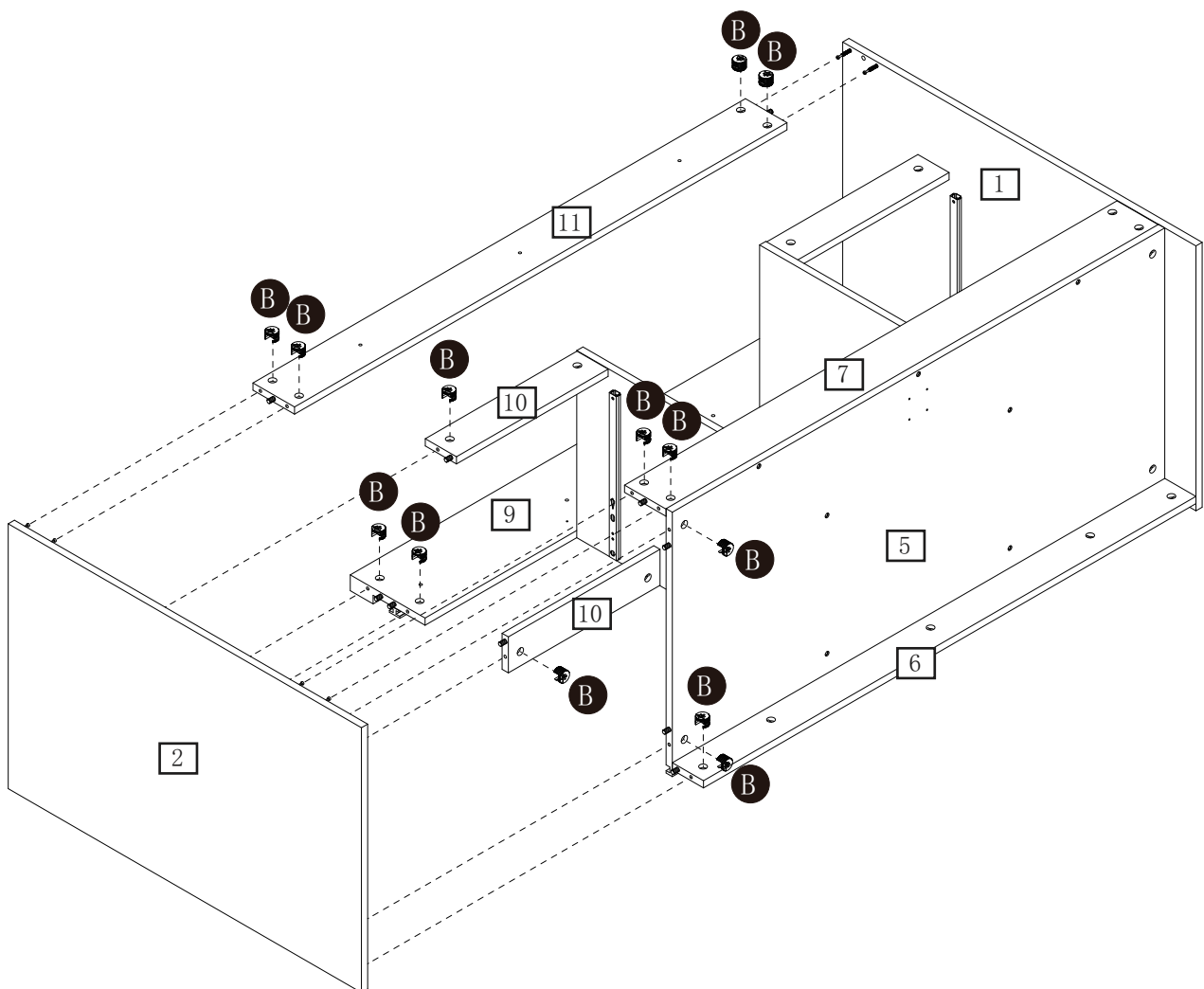

Attach part (2) to parts (5, 6, 7, 9, 10, 11), then insert and secure cam lock (B) to parts (5, 6, 7, 9, 10, 11) to lock them.

Attach part (1) to part (11), then insert and secure cam lock (B) to part (11) to lock it.

# Assembly Instructions

## Step 14

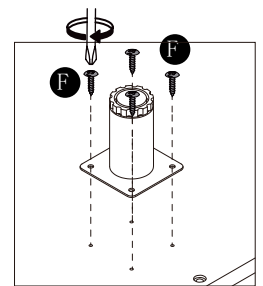
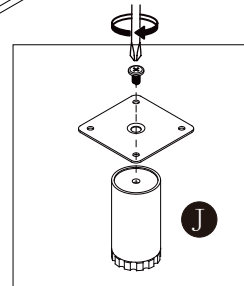
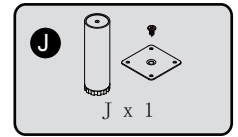
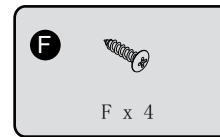
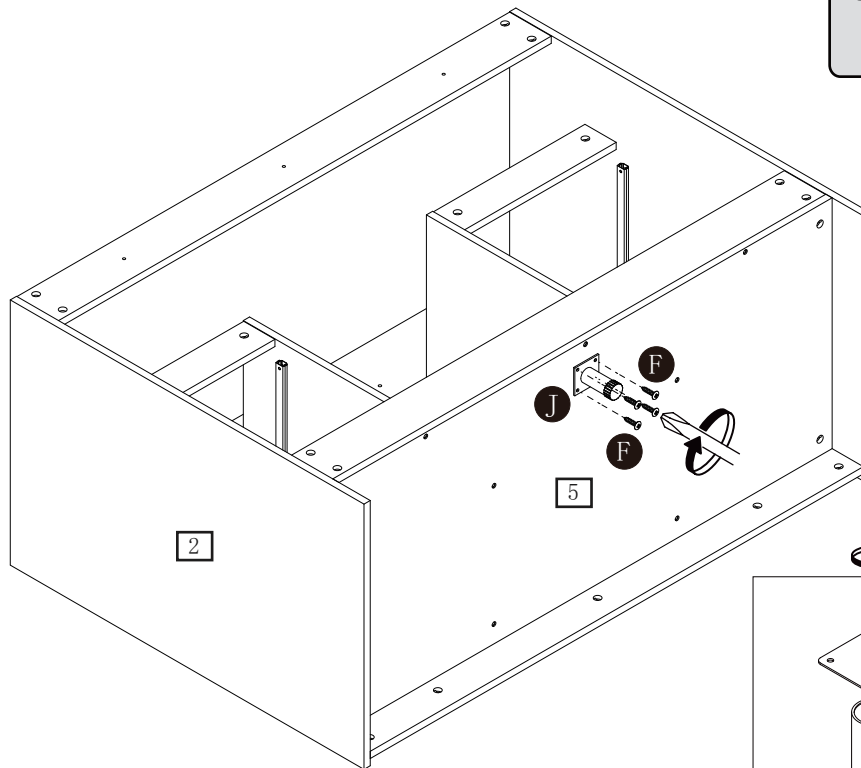

Assemble the adjustable foot (J), then attach it to part (5) using screw (F).

## Step 15

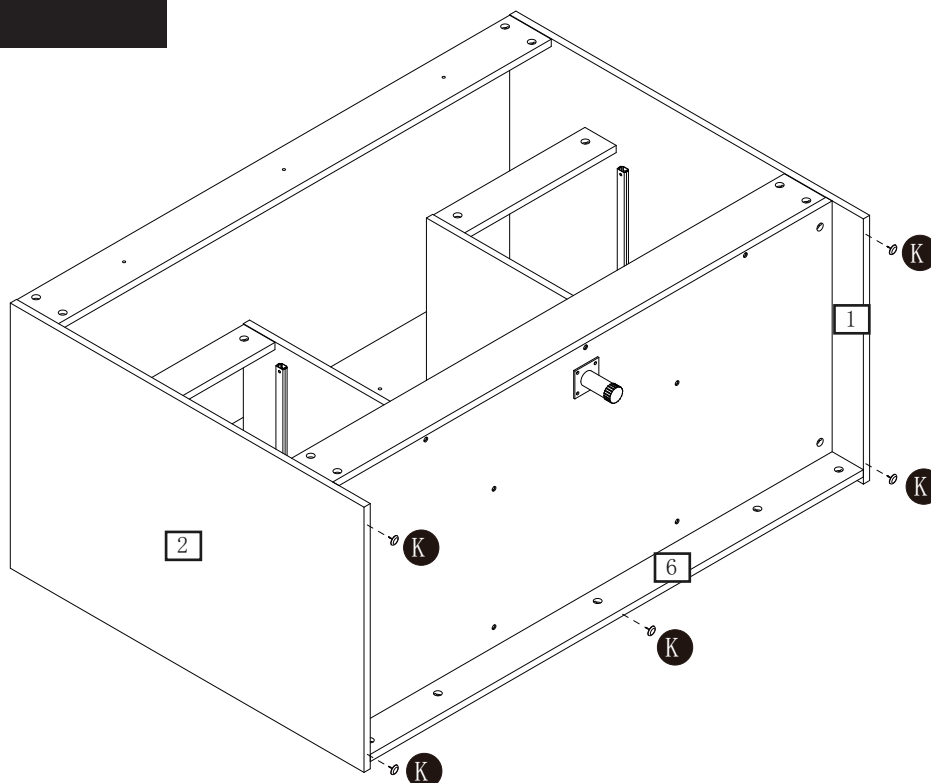

Insert protective foot (K) into parts (1, 2, 6).

# Assembly Instructions

## Step 16

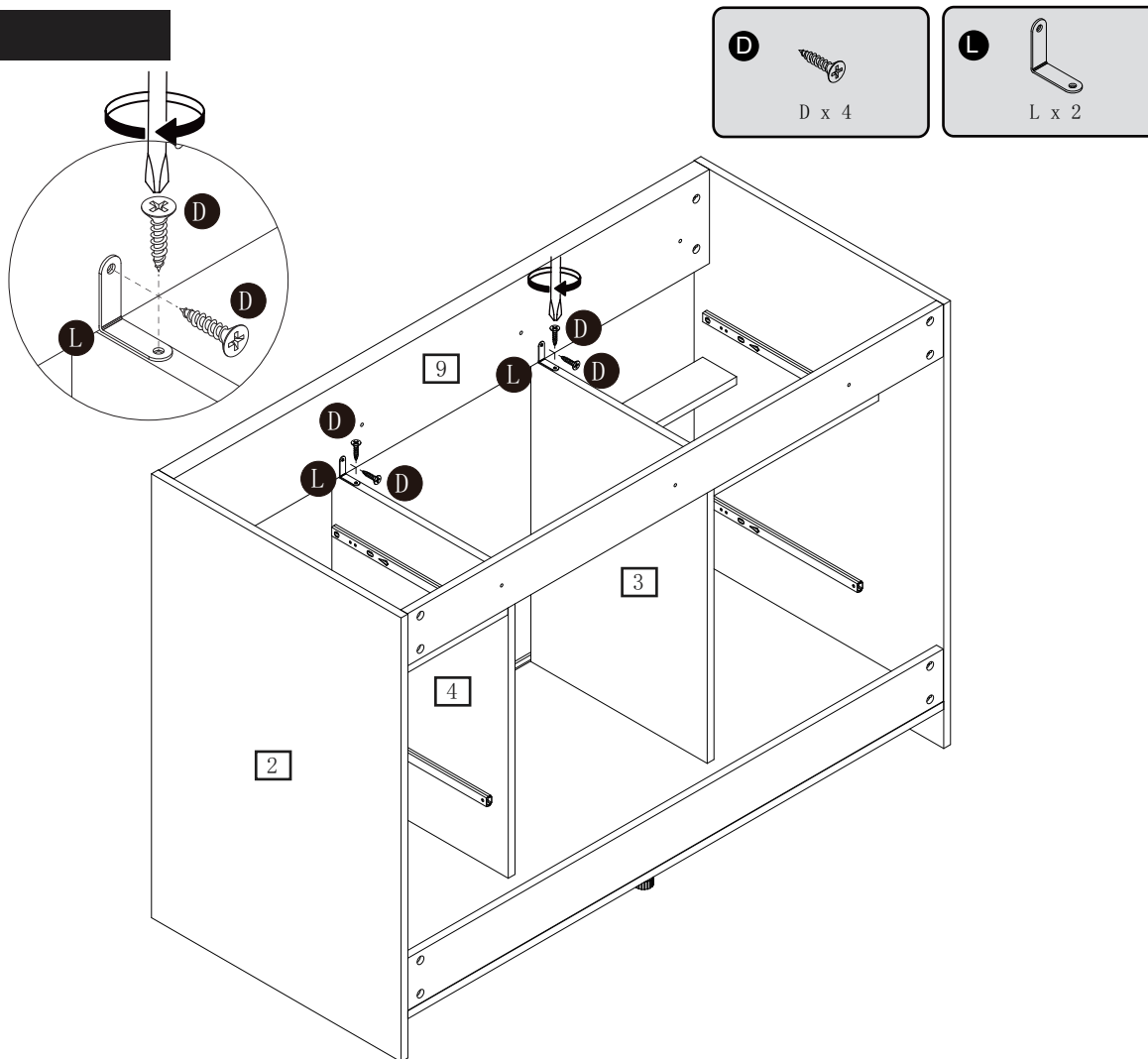

Attach L-shape bracket (L) to parts (3, 4, 9) using scew (D) and a screwdriver.

## Step 17

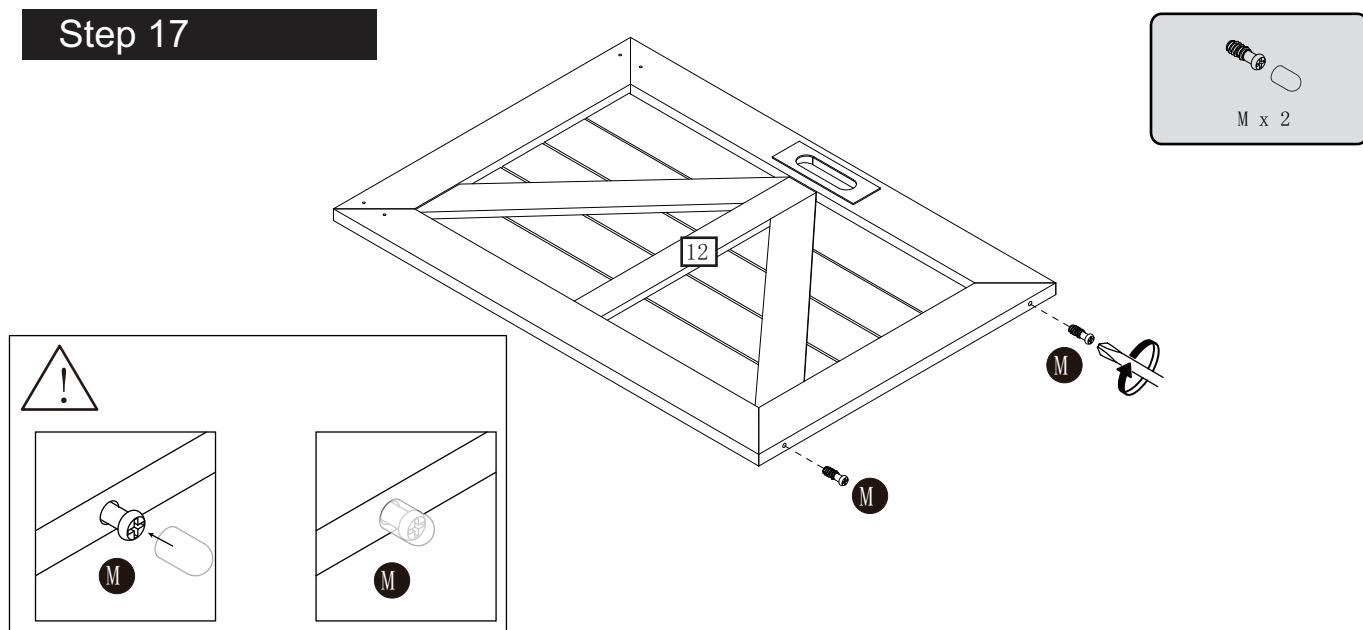

Attach screw and plastic cap (M) to part (12) with a screwdriver.

# Assembly Instructions

## Step 18

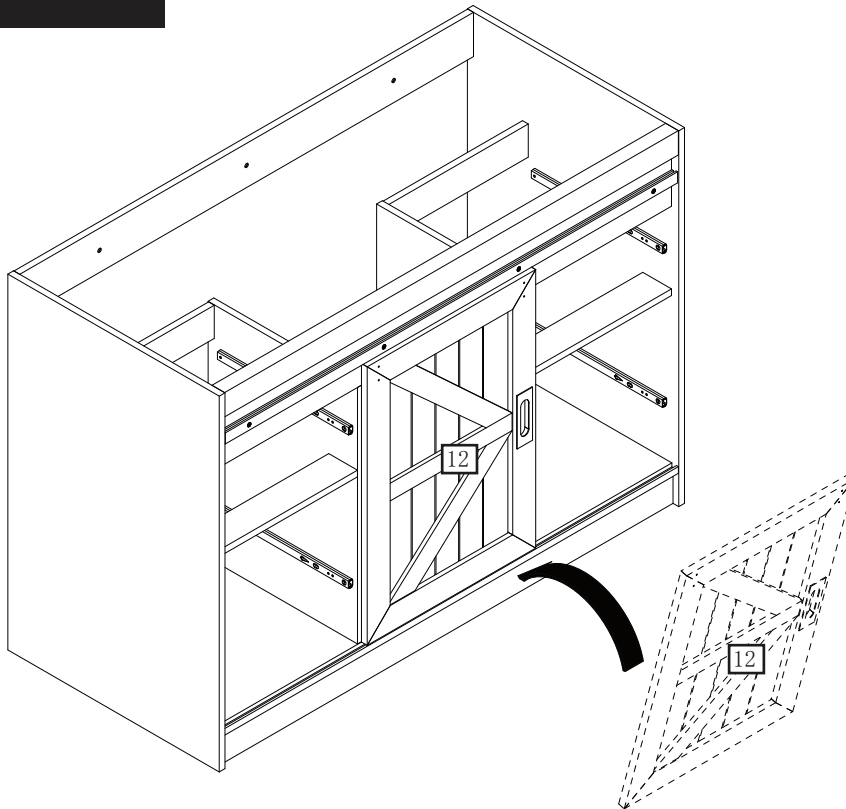

Place door (12) on the track.

## Step 19

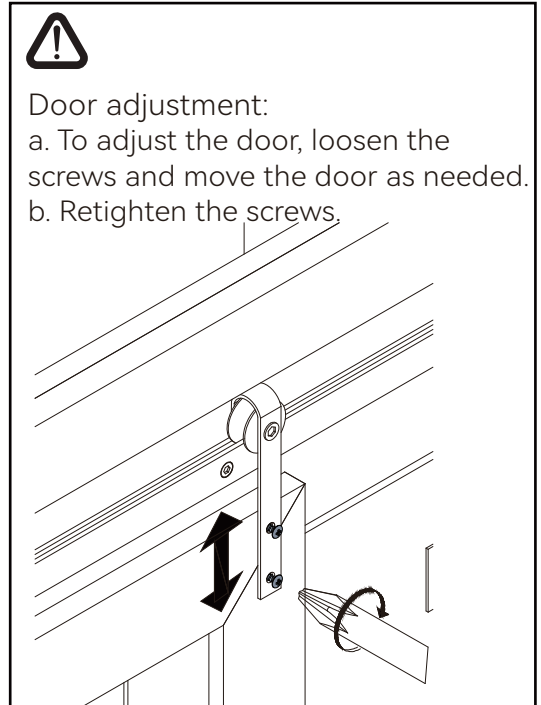
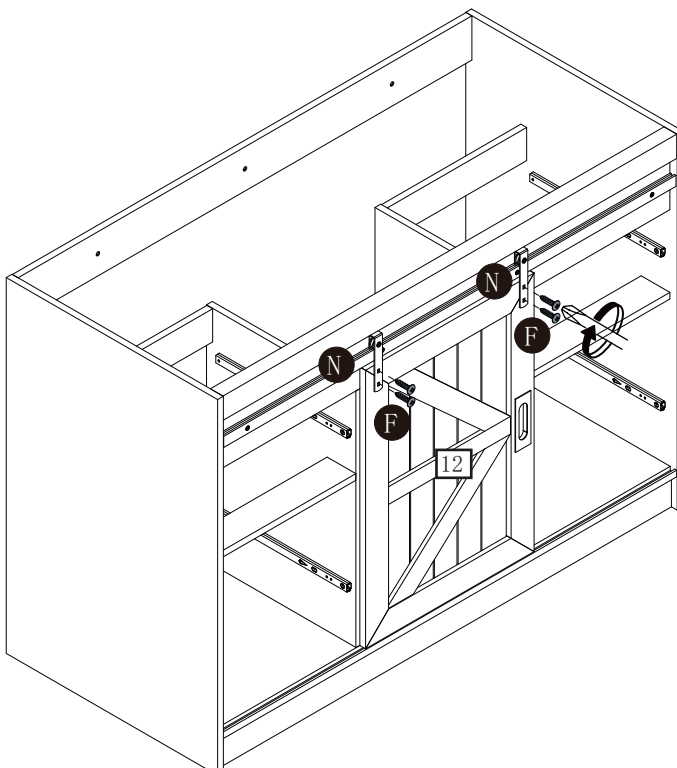
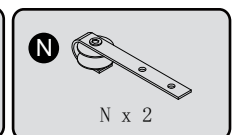
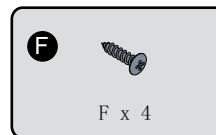

Place pulley (N) on the bar, then attach pulley (N) to door (12) using screw (F) and a screwdriver.

# Assembly Instructions

## Step 20

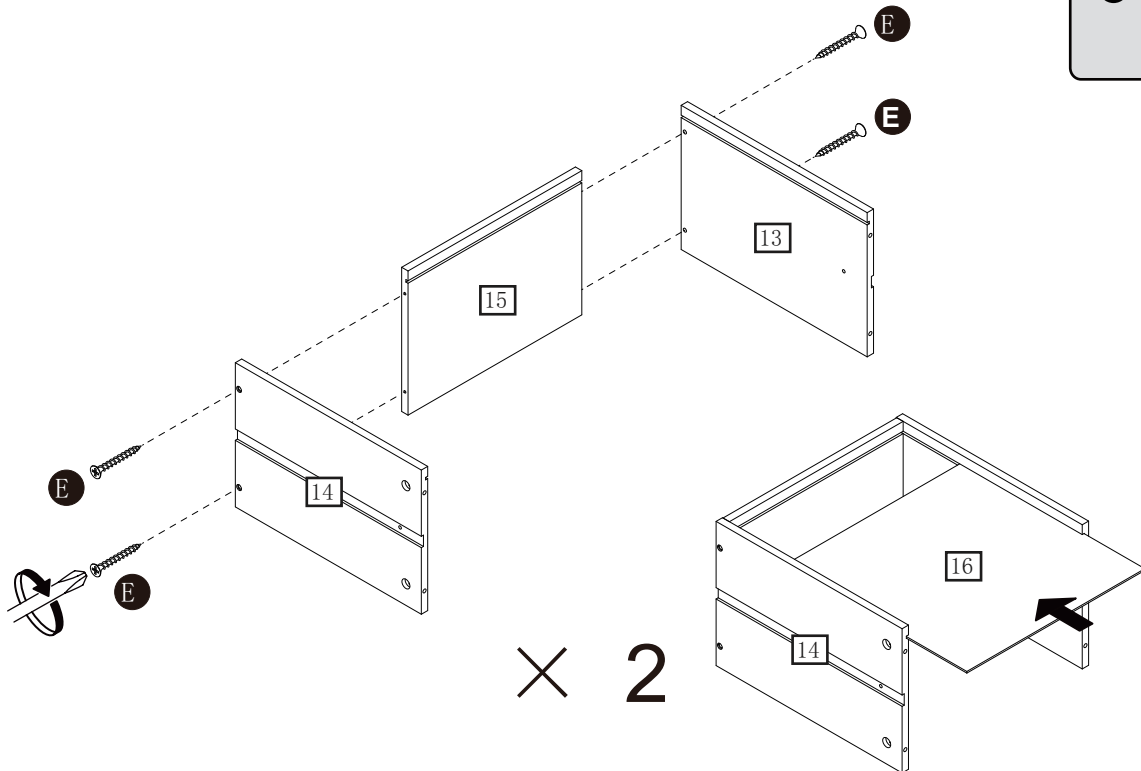

Attach parts (13, 14) to part (15) using screw (E) and a screwdriver.  
Slide part (16) into the grooves.

## Step 21

### CAM-LOCK

Tighten until shoulder is flush with panel. Do not overtighten or undertighten (see example below)

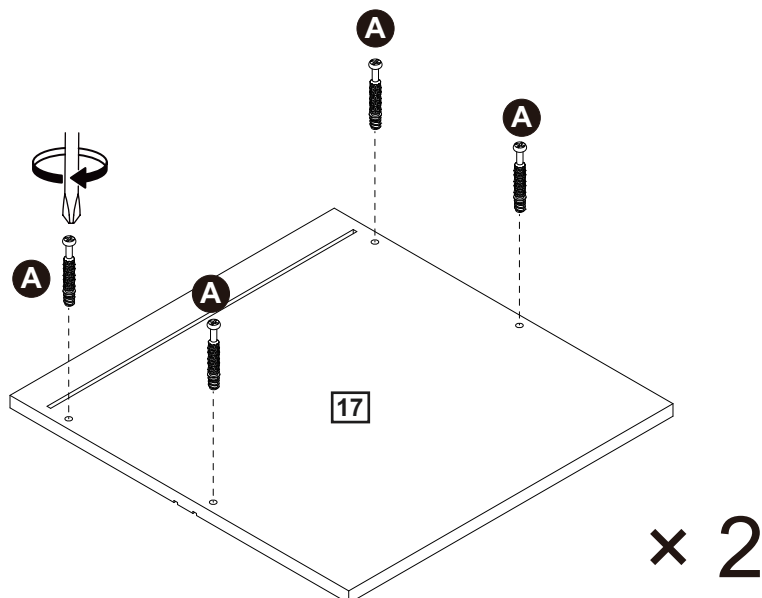
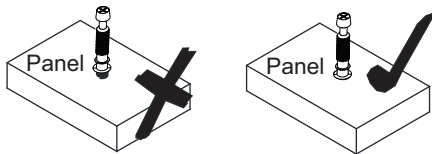

Attach cam bolt (A) to part (17) with a screwdriver.

# Assembly Instructions

## Step 22

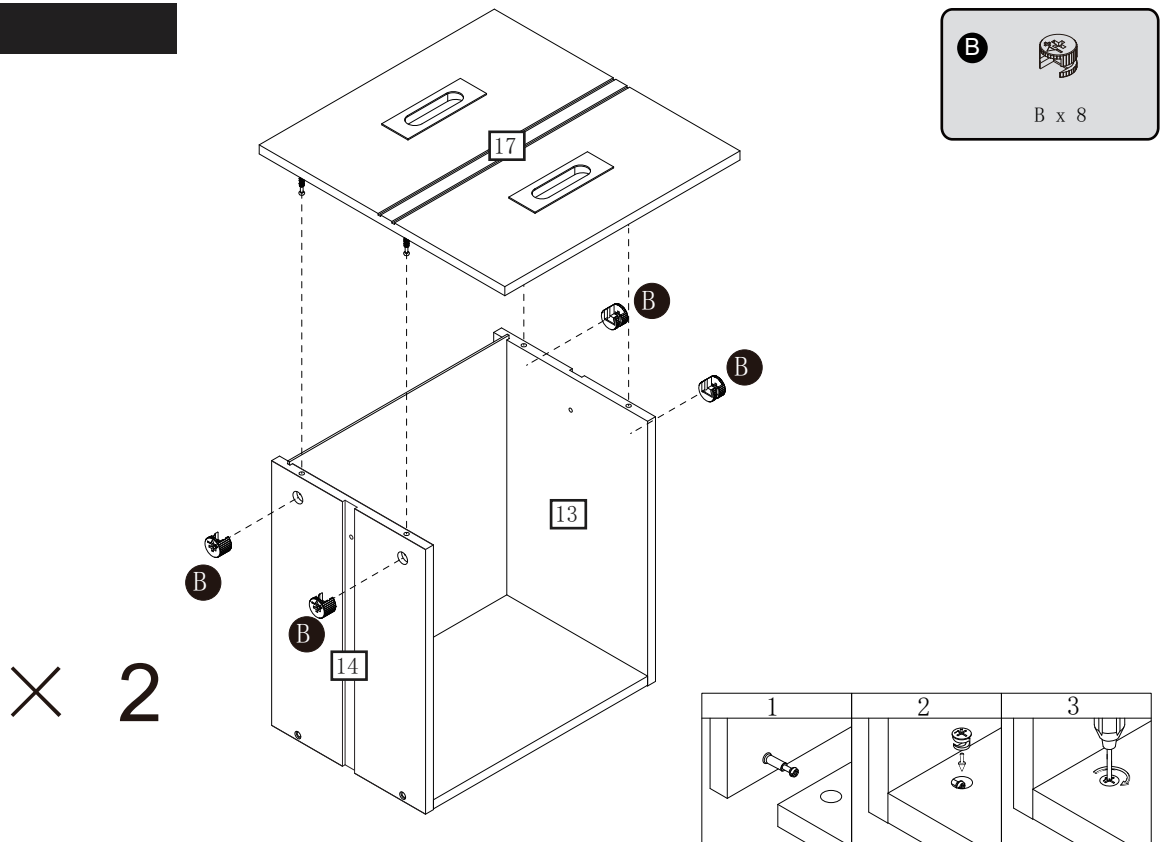

Attach part (17) to parts (13, 14), then insert and secure cam lock (B) to parts (13, 14) to lock them.

## Step 23

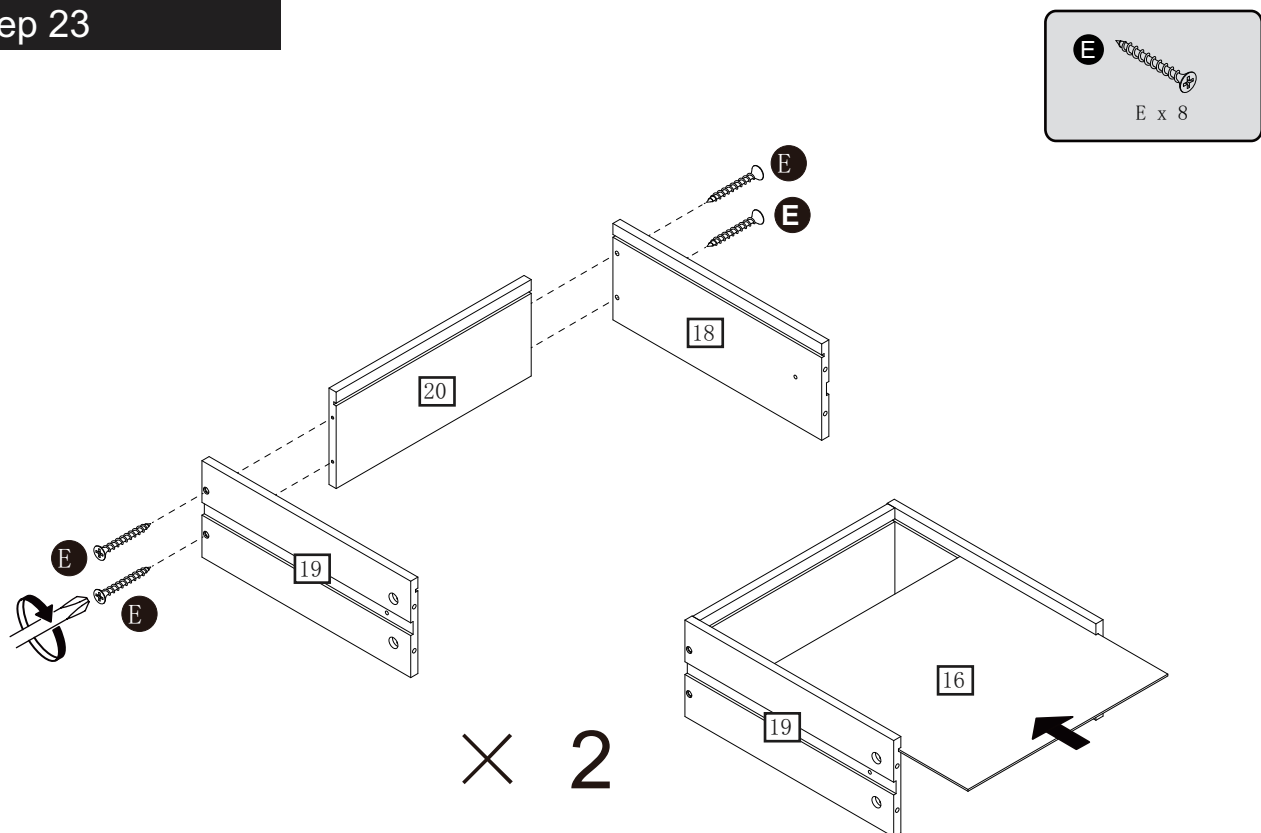

Attach parts (18, 19) to part (20) using screw (E) and a screwdriver.  
Slide part (16) into the grooves.

# Assembly Instructions

## Step 24

### CAM-LOCK

Tighten until shoulder is flush with panel. Do not overtighten or undertighten (see example below)

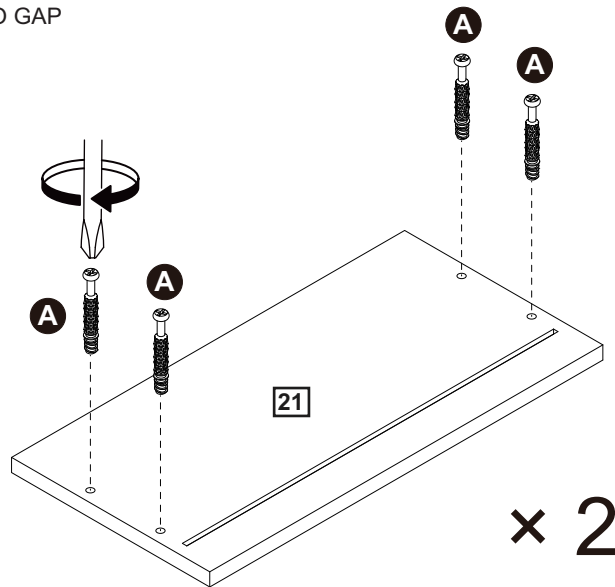
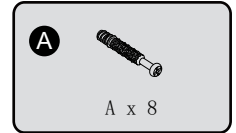
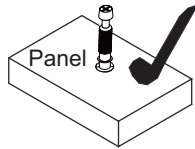
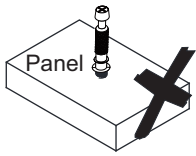

Attach cam bolt (A) to part (21) with a screwdriver.

## Step 25

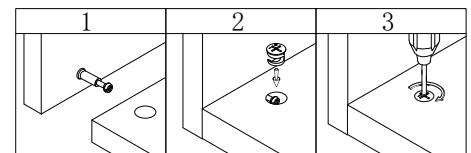
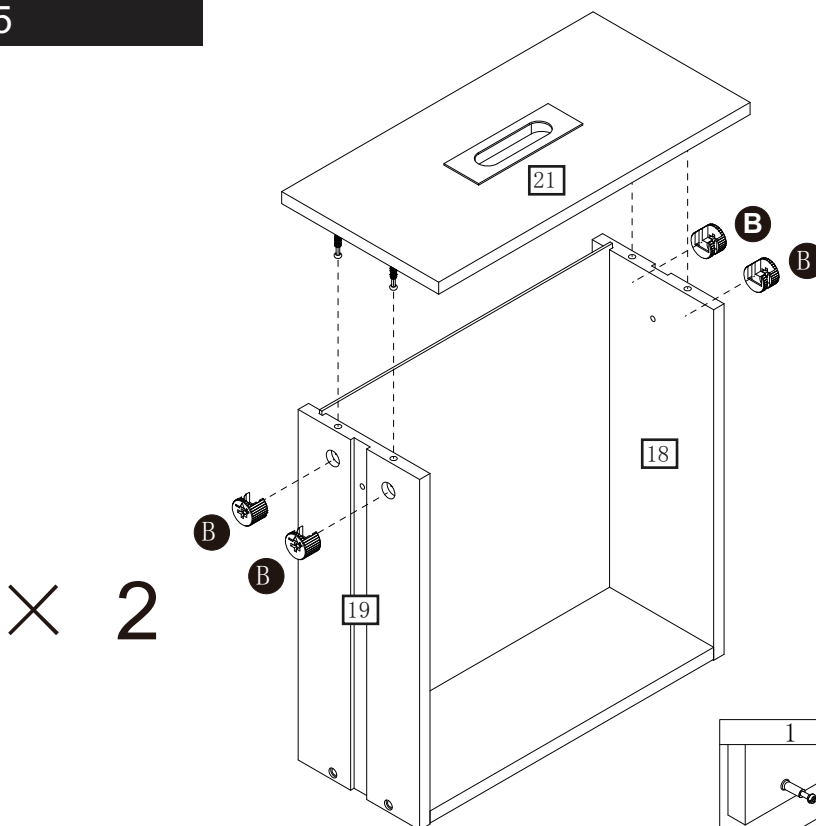

Attach part (21) to parts (18, 19), then insert and secure cam lock (B) to parts (18, 19) to lock them.

# Assembly Instructions

## Step 26

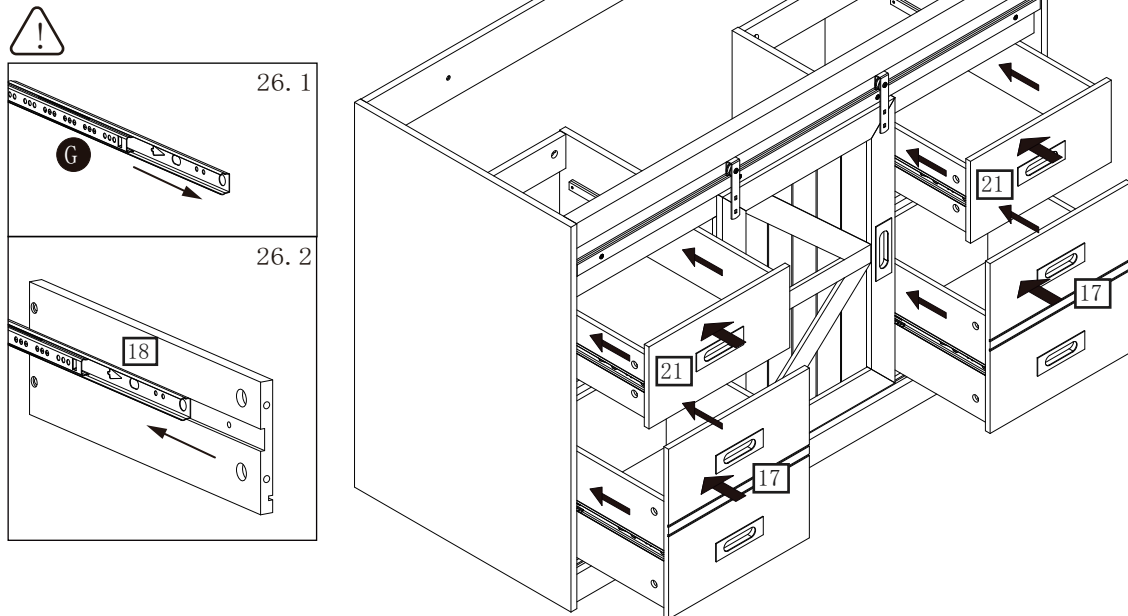

Slide the drawer slide (G) into the grooves on both sides of the drawer as shown in the diagram.

## Step 27

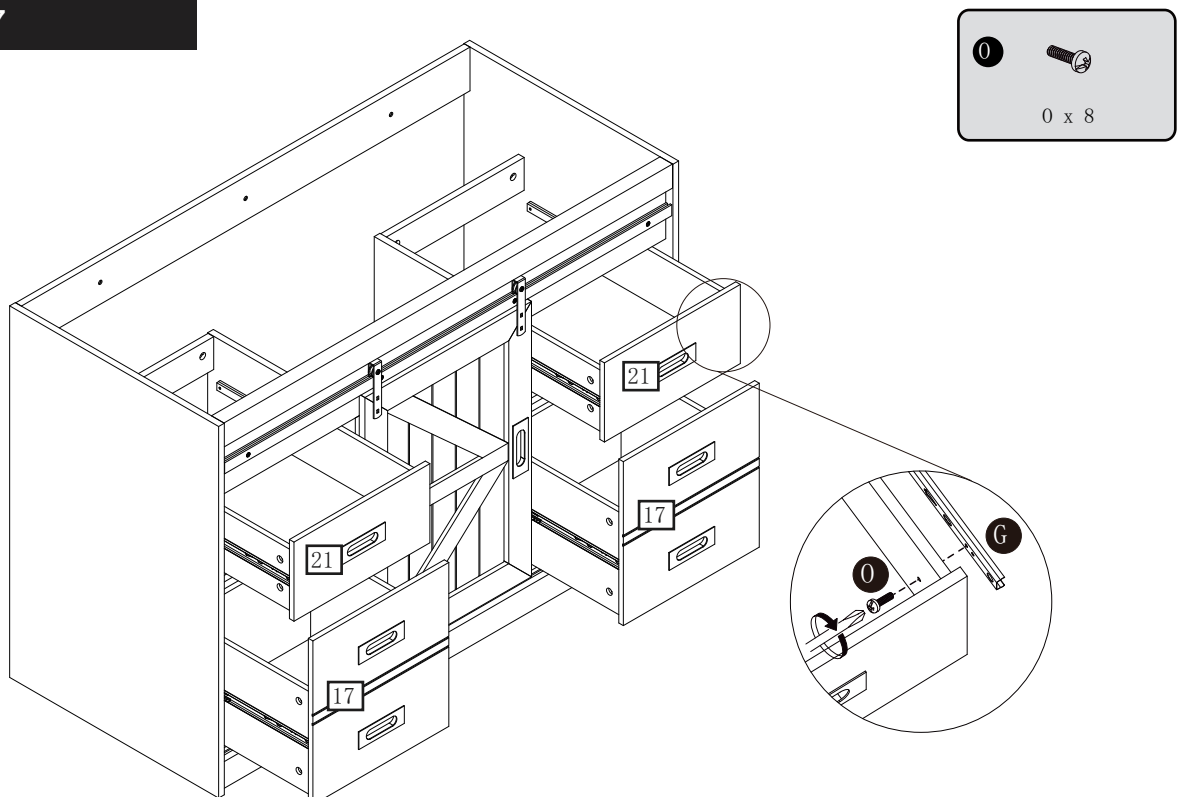

Use screw (O) to secure drawer slide (G) to the drawer.

# Assembly Instructions

## Step 28

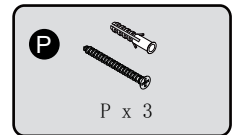
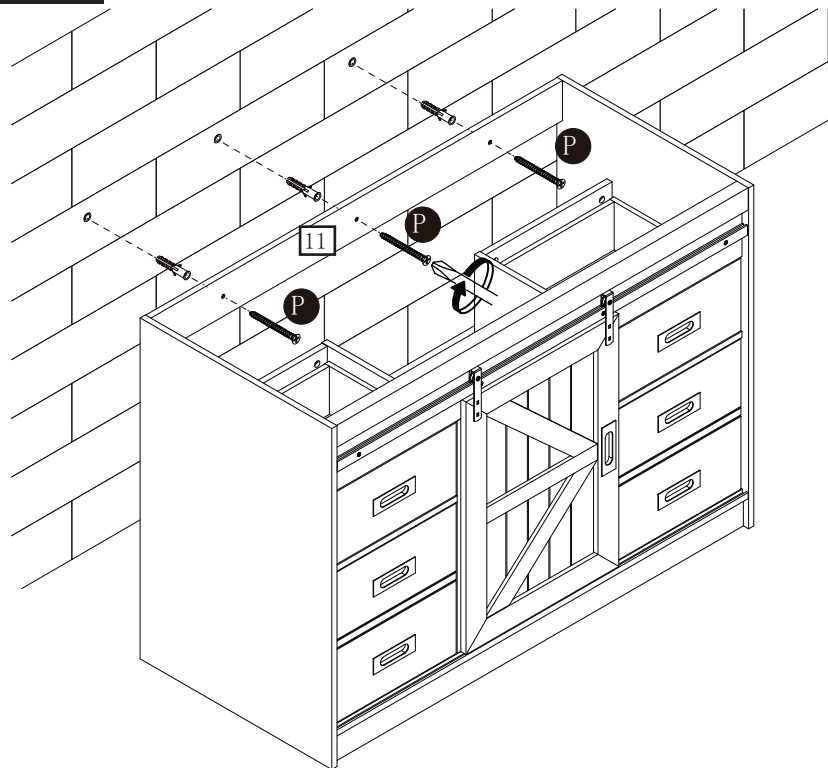

Secure the vanity to the wall using appropriate wall plugs and screw (P).

## Step 29

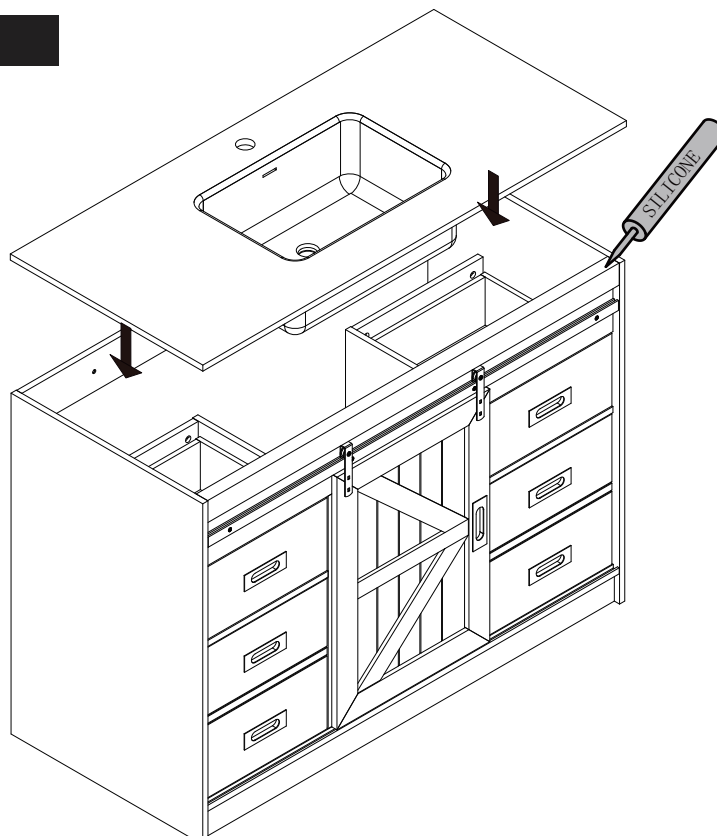

Apply a thin layer of silicone sealant around the top of the vanity, then carefully set the sink in place.

Wipe off any excess silicone with a damp rag.

# A Guide to Wall Mounting & Fixings

## Important note:

If plastic wall plugs (rawl plugs) are supplied with your product, e.g.:



- these are only suitable for use in masonry walls.

If you are in any doubt about the correct wall plugs for your wall, seek professional advice.

Failure of the product due to using the incorrect fixings is the responsibility of the installer.



**Important:** when drilling into walls always check that there are no hidden wires or pipes etc.

Make sure that the screws and wall plugs being used are suitable for **supporting your unit**. **Consult a qualified tradesperson if you are unsure.**

Hints:

- 1: General rule:  always use a larger screw and wall plug if you are not sure.
- 2: Ensure you use the recommended drill bit to match the wall plug and hole size.
- 3: Ensure you drill the hole horizontally; do not force the drill or enlarge the hole.
- 4: Take extra care when drilling high walls, ceilings and ceramic tiles. Ensure wall plugs are inserted beyond the thickness of the ceramic tiles to avoid the tiles splitting or cracking.
- 5: Ensure wall plugs are well fitted and are a tight fit in the drilled hole.

## Types of walls

You can use one of the following types of wall plug if your walls are made of brick, breeze block, concrete, stone or wood.

No.1 "General Purpose" wall plug

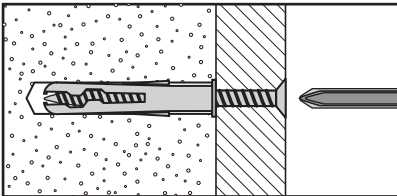

Generally aerated blocks should not be used to support heavy loads, use a specialist fitting in this case. For light loads, general purpose wall plugs can be used.

No.2 "Plasterboard" wall plug

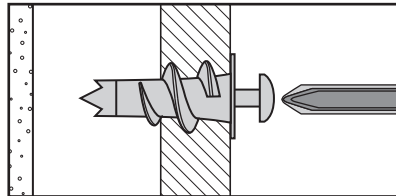

For use when attaching light loads onto plasterboard partitions.

No.3 "Cavity Fixing" wall plug

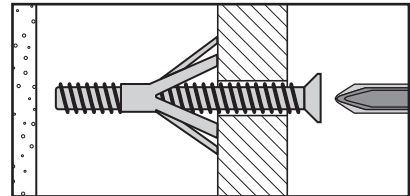

For use with plasterboard partitions or hollow wooden doors.

No.4 "Cavity Fixing – Heavy Duty" wall plug

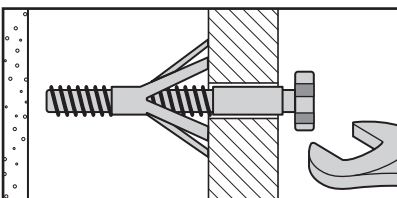

For use when fitting or supporting heavy loads such as shelving, wall cabinets and coat racks.

No.5 "Hammer Fixing" wall plug

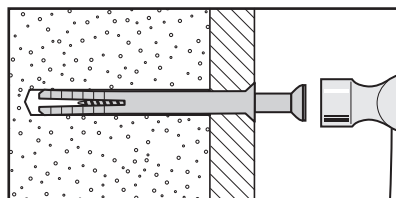

For use with walls stuck with plasterboard. The hammer fixing allows it to be fixed to the wall rather than the plasterboard. Always check the fixing is secure to the retaining wall.

No.6 "Shield Anchor" wall plug – heavy loads

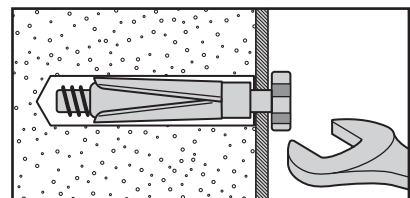

For use with heavier loads such as TV and HiFi speakers and satellite dishes etc.



## Care & Maintenance

**Safety:** always check the fitting and location to ensure your safety in and around the home.

**Fitting:** from time to time check the fitting to ensure the wall plugs or screws do not become loose.